

Aircraft Flight Manual

Doc. No. 2006/044

4th Edition – Rev. 2

2017, March 16th



TECNAM P2006T

MANUFACTURER: *COSTRUZIONI AERONAUTICHE* **TECNAM** S.r.l.

AIRCRAFT MODEL: **P2006T**

EASA TYPE CERTIFICATE NO: **A .185** (DATED 2009, JUNE 5TH)

SERIAL NUMBER:

BUILD YEAR:

REGISTRATION MARKINGS:

*This Aircraft Flight Manual is approved by **European Aviation Safety Agency (EASA)**.*

This Manual contains information required by the FAA to be furnished to the pilot for operation in the U.S.A. plus information supplied by the manufacturer. It is approved by EASA on behalf of the FAA per FAR 21.29.

This Manual must be carried in the airplane at all times.

The airplane has to be operated in compliance with procedures and limitations contained herein.

Costruzioni Aeronautiche **TECNAM** srl

Via Maiorise

CAPUA (CE) – Italy

Tel. +39 (0) 823.62.01.34

WEB: www.tecnam.com

SECTION 0

INDEX

1. RECORD OF REVISIONS	3
2. LIST OF EFFECTIVE PAGES	7
3. FOREWORD	10
4. SECTIONS LIST.....	11

1. RECORD OF REVISIONS

Any revision to the present Manual, except actual weighing data, is recorded: a Record of Revisions is provided at the front of this manual and the operator is advised to make sure that the record is kept up-to-date.

The Manual issue is identified by Edition and Revision codes reported on each page, lower right side.

The revision code is numerical and consists of the number "0"; subsequent revisions are identified by the change of the code from "0" to "1" for the first revision to the basic publication, "2" for the second one, etc.

Should be necessary to completely reissue a publication for contents and format changes, the Edition code will change to the next number ("2" for the second edition, "3" for the third edition etc).

Additions, deletions and revisions to existing text will be identified by a revision bar (black line) in the left-hand margin of the page, adjacent to the change.

When technical changes cause expansion or deletion of text which results in unchanged text appearing on a different page, a revision bar will be placed in the right-hand margin adjacent to the page number of all affected pages providing no other revision bar appears on the page.

These pages will be updated to the current regular revision date.

NOTE: It is the responsibility of the owner to maintain this handbook in a current status when it is being used for operational purposes.

Rev	Revised page	Description of Revision	Tecnam Approval			EASA Approval or Under DOA Privileges
			DO	OoA	HDO	
0	-	First issue	D. Ronca	M. Oliva	M. Oliva	
1	0-4	Amend ROR	D. Ronca	M. Oliva	M. Oliva	Approved under the authority of DOA, ref. EASA.21J.335 (MOD2006/270.160429)
	0-8	Amend LOEP	D. Ronca	M. Oliva	M. Oliva	
	6-12	Amend Equipment List	D. Ronca	M. Oliva	M. Oliva	
	9-1 & 2	Amend Supplement List Index	D. Ronca	M. Oliva	M. Oliva	
	9-5	Amend Supplement List	D. Ronca	M. Oliva	M. Oliva	
	9-7	Amend Supplement List	D. Ronca	M. Oliva	M. Oliva	
	-	Add Supplement A24	D. Ronca	M. Oliva	M. Oliva	
	-	Add Supplement A25	D. Ronca	M. Oliva	M. Oliva	
	-	Add Supplement G14	D. Ronca	M. Oliva	M. Oliva	
	-	Add Supplement G16	D. Ronca	M. Oliva	M. Oliva	
-	Add Supplement G17	D. Ronca	M. Oliva	M. Oliva		
2	4-3, 4	Amend General recommendation	D. Ronca	M. Oliva	M. Oliva	Approved under the authority of DOA, ref. EASA.21J.335 (MOD2006/290.170316)
	4-18, 19	Amend "Prior to Takeoff" procedure	D. Ronca	M. Oliva	M. Oliva	
	5-16	Amend Cruise performances	D. Ronca	M. Oliva	M. Oliva	
	9-1,2,4,5,7	Amend Supplement List Index	D. Ronca	M. Oliva	M. Oliva	
	-	Add Supplement A13B	D. Ronca	M. Oliva	M. Oliva	
		Add Supplement A26	D. Ronca	M. Oliva	M. Oliva	
	-	Add Supplement A27	D. Ronca	M. Oliva	M. Oliva	
	-	Add Supplement G18	D. Ronca	M. Oliva	M. Oliva	

INTENTIONALLY LEFT BLANK

INTENTIONALLY LEFT BLANK

2. LIST OF EFFECTIVE PAGES

The List of Effective Pages (LOEP), applicable to manuals of every operator, lists all the basic AFM pages: each manual could contain either basic pages or one variant of these pages when the pages of some Supplements are embodied.

Should the Supplements be embodied in accordance with approved instructions, make reference to the LOEP addressed on the Supplements themselves.

- 1st Edition, Rev 0 May 25, 2009**
- 2nd Edition, Rev 0 March 29, 2010**
- 2nd Edition, Rev 1 April 27, 2010**
- 2nd Edition, Rev 2 November 12, 2010**
- 2nd Edition, Rev 3 March 4, 2011**
- 3rd Edition, Rev 0 December 22, 2011**
- 3rd Edition, Rev 1 October 15, 2012**
- 3rd Edition, Rev 2 June 4, 2013**
- 3rd Edition, Rev 3..... February 13, 2014**
- 3rd Edition, Rev 4..... May 5, 2014**
- 3rd Edition, Rev 5..... June 10, 2015**
- 4th Edition, Rev 0 July 25, 2015**
- 4th Edition, Rev 1 April 6, 2016**
- 4th Edition, Rev 2 March 16, 2017**

Section	Pages	Revision
Section 0	Pages 1 thru 3, 5, 6, 8 thru 11	Rev 0
	Pages 4,7	Rev 1
Section 1	Pages 1 thru 18	Rev 0
Section 2	Pages 1 thru 32	Rev 0
Section 3	Pages 1 thru 58	Rev 0
Section 4	Pages 1,2,5 thru 17 and Pages 20 thru 29	Rev 0
	Pages 3,4,18, 19	Rev 2
Section 5	Pages 1 thru 15 and Pages 17 thru 23	Rev 0
	Page 16	Rev 2
Section 6	Pages 1 thru 10	Rev 0
	Pages 11 thru 12	Rev 1
	Pages 13 thru 14	Rev 0
Section 7	Pages 1 thru 44	Rev 0
Section 8	Pages 1 thru 10	Rev 0
Supplements		
Section 9	Pages 1, 2, 5, 7	Rev 1
	Pages 3, 4, 6, 8	Rev 0
Supplements LOEP: make reference to the Supplements Cover Pages		

INTENTIONALLY LEFT BLANK

INTENTIONALLY LEFT BLANK

3. FOREWORD

Tecnam *P2006T* is a twin-engine four-seat aircraft with high cantilevered wing and tri-cycle retractable landing gear.

Section 1 supplies general information and it contains definitions, symbols explanations, acronyms and terminology used.



Before using the airplane, you are recommended to read carefully this manual: a deep knowledge of airplane features and limitations will allow you for operating the airplane safely.

For further information, please contact:

*COSTRUZIONI AERONAUTICHE **TECNAM** s.r.l.*

Via MAIORISE

CAPUA (CE) - ITALY

 +39 (0) 823.62.01.34  www.tecnam.com

4. SECTIONS LIST

General	Section 1 (a non-approved Chapter)
Limitations	Section 2 - EASA Approved Chapter
Emergency Procedures	Section 3 (a non-approved Chapter)
Normal Procedures	Section 4 (a non-approved Chapter)
Performances	Section 5 (a non-approved Chapter)
Weight and Balance	Section 6 (a non-approved Chapter)
Airframe and Systems description	Section 7 (a non-approved Chapter)
Airplane Care and Maintenance	Section 8 (a non-approved Chapter)
Supplements	Section 9 (*)

(*) EASA approved parts, if any, are reported on the supplements

SECTION 1 - GENERAL**INDEX**

1. Introduction	3
2. Three-view and dimensions.....	4
3. Control Surfaces Travel Limits	6
4. Engine	6
5. Propeller	6
6. Governor	7
7. Fuel	7
8. Lubrication.....	7
9. Cooling	8
10. Maximum weights.....	8
11. Standard weights.....	8
12. Specific loadings	8
13. Acronyms and terminology.....	10
14. Unit conversion chart	15
15. Litres / US gallons conversion chart	16

INTENTIONALLY LEFT BLANK

1. INTRODUCTION

The Aircraft Flight Manual has been implemented to provide the owners with information for a safe and efficient use of the aircraft TECNAM P2006T.

Warning – Caution – Note

Following definitions apply to warnings, cautions and notes used in the Aircraft Flight Manual.



The non-observation of the corresponding procedure can lead, as immediate effect, to a significant reduction of the flight safety.



The non-observation of the corresponding procedure can lead to an equipment damage which leads to a reduction of the flight safety in a short or longer time interval.



Draws the attention to a procedure not directly related to safety of flight.

2. THREE-VIEW AND DIMENSIONS

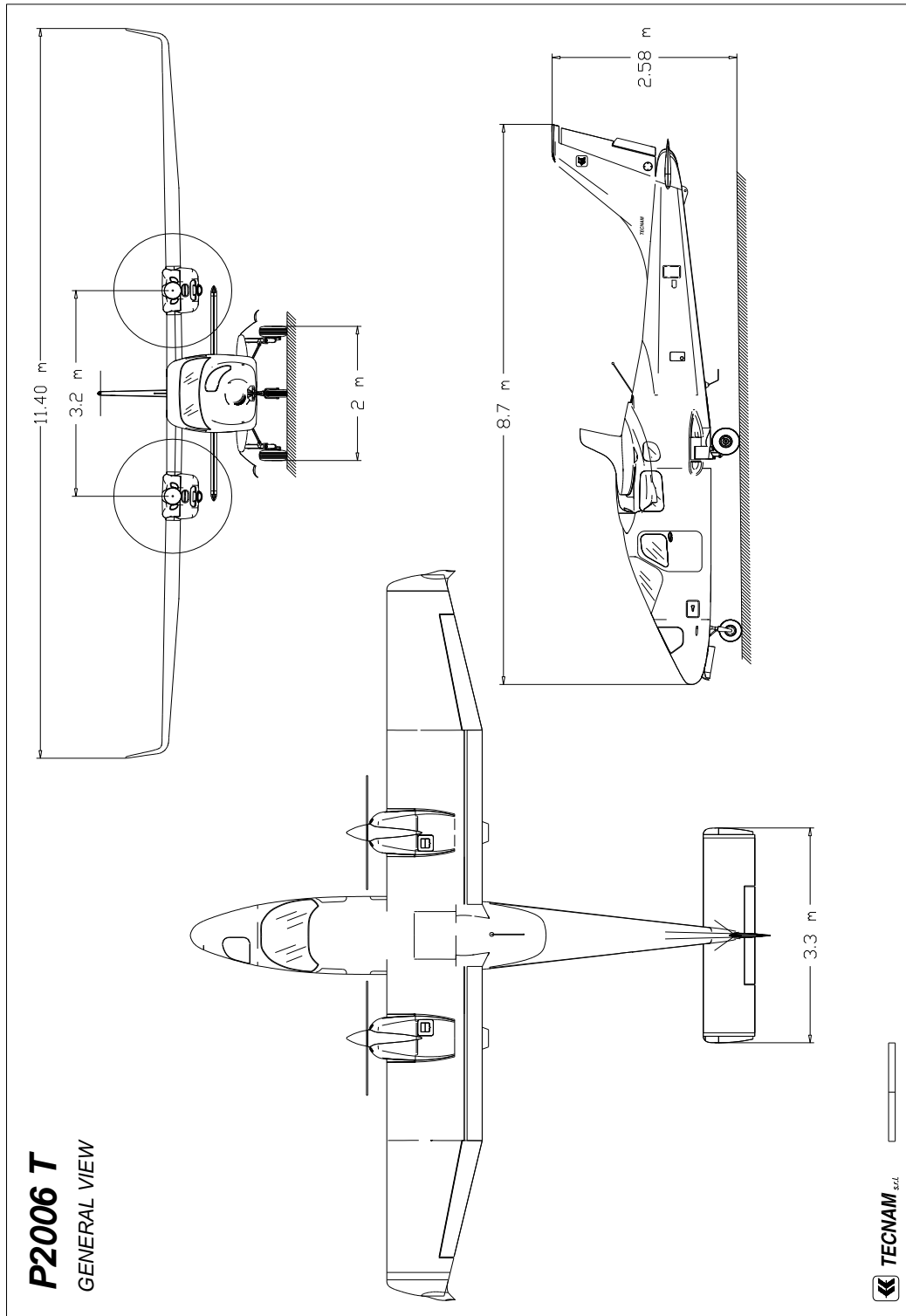

Figure 1 – General views

Dimensions

Overall dimensions

Wingspan	11,4 m	37,4 ft
Length	8,7 m	28,5 ft
Overall height	2,58 m	8,46 ft

Wing

Wing surface	14,76 m ²	158,9 ft ²
Mean Geometric Chord	1,295 m	4,25 ft
Dihedral	1°	
Aspect ratio	8,80	

Main Landing Gear

Track	2.0 m
Wheelbase	2.9 m
Tire	6.00-6
Wheel rim assembly (Cleveland)	P/N 40-59A

Nose Landing Gear

Tire	5.00 – 5
Wheel rim assembly (Cleveland)	P/N 40-77C

3. CONTROL SURFACES TRAVEL LIMITS

Ailerons	Up 20° Down 17° ($\pm 2^\circ$)
Stabilator (refer to Trailing Edge)	Up 4° Down 15° ($\pm 2^\circ$)
Stabilator trim tab (refer to Trailing Edge)	Up 2°; Down 19° ($\pm 2^\circ$)
Rudder	RH 26° LH 26° ($\pm 2^\circ$)
Rudder trim tab	RH 20° LH 20° ($\pm 2^\circ$)
Flaps	0°; 40° ($- 2^\circ$)

4. ENGINE

Manufacturer	Bombardier-Rotax GmbH
Model	912 S3
Certification basis	FAR 33 - Amendment 15
Type Certificate	EASA TCDS no. E.121 dated 1 April 2008
Engine type	4 cylinders horizontally opposed with 1352 c.c. of overall displacement, liquid cooled cylinder heads, ram-air cooled cylinders, two carburetors, integrated reduction gear box with torsional shock absorber and overload clutch.
Maximum power (at declared rpm)	73.5 kW (98.6hp) @ 5800 rpm –5 minutes maximum. 69.0 kW (92.5hp) @ 5500 rpm (continuous)

5. PROPELLER

Manufacturer	MT Propeller
Type Certificate	LBA 32.130/086 (MTV-21 series)
Model	MTV-21-A-C-F/CF178-05
Blades/hub	2 wood/composite blades – aluminum hub
Diameter	1780 mm (no reduction allowed)
Type	Variable pitch - hydraulically controlled

6. GOVERNOR

Manufacturer	Mt Propeller
Model	P-875-12
Type	Hydraulic

7. FUEL

Approved fuel:	MOGAS ASTM D4814 MOGAS EN 228 Super/Super plus (min. RON 95) AVGAS 100LL (ASTM D910) <i>(see also Section 2)</i>
----------------	--

Fuel tanks	Two integrated tanks (one in each wing) fitted with drainable sump and drain valve
Capacity of each wing tank	100 litres (26,42 US gallons)
Tanks overall capacity	200 litres (52,8 US gallons)
Overall usable fuel	194.4 litres (51,35 US gallons)
Overall unusable fuel	5.6 litres (1,48 US gallons)

8. LUBRICATION

Lubrication system	Forced type with external reservoir
Oil	Use only oil with API classification “SG” or higher. For additional info, refer to “Rotax Operators Manual” – last issue -, “Operating Media” Section.
Oil capacity	Max. 3.0 litres – min. 2.0 litres (<i>per tank</i>)

9. COOLING

Cooling system	Ram-air cooled cylinders, liquid cooled cylinder heads (closed and pressurized circuit)
Coolant liquid	Certified for Water/Coolant mixture. Make reference to “Rotax Operators Manual” – last issue
Overall circuit capacity	1410 cm ³

10. WEIGHTS

See Section 2.

11. STANDARD WEIGHTS

Empty Weight: see weighing record on Section 6

12. SPECIFIC LOADINGS

	MTOW 1180 kg (2601 lb)	MTOW 1230 kg (2712 lb)
Wing Loading	80 kg/m ² (16,37 lb/sqft)	83 kg/m ² (17,1 lb/sqft)
Power Loading	6.0 kg/hp (13,26 lb/hp)	6.28 kg/hp (13,84 lb/hp)

NOTE. Reference is made to both MTOW: 1180 kg and 1230 kg (if Supplement A19 or G10 - Increased MTOW @1230 KG - is applicable).

INTENTIONALLY LEFT BLANK

13. ACRONYMS AND TERMINOLOGY

KCAS	<u>Calibrated Airspeed</u> is the indicated airspeed expressed in knots, corrected taking into account the errors related to the instrument itself and its installation.
KIAS	<u>Indicated Airspeed</u> is the speed shown on the airspeed indicator and it is expressed in knots.
KTAS	<u>True Airspeed</u> is the KCAS airspeed corrected taking into account altitude and temperature.
V _A	<u>Design Manoeuvring speed</u> is the speed above the which it is not allowed to make full or abrupt control movement.
V _{FE}	<u>Maximum Flap Extended speed</u> is the highest speed permissible with flaps extended.
V _{LO}	<u>Maximum Landing Gear Operating speed</u> is the maximum speed allowed to retract or to extend the landing gear.
V _{LE}	<u>Maximum Landing Gear Extended speed</u> is the maximum speed allowed with the landing gear extended.
V _{MC}	<u>Minimum control speed</u> : is the minimum speed necessary to ensure an efficient aircraft control in case of one engine inoperative.
V _{NO}	<u>Maximum Structural Cruising Speed</u> is the speed that should not be exceeded, except in smooth air and only with caution.
V _{NE}	<u>Never Exceed Speed</u> is the speed limit that may not be exceeded at any time.
V _O	<u>Operating Manoeuvring speed</u> is the speed above the which it is not allowed to make full or abrupt control movement
V _S	<u>Stall Speed</u> .
V _{S0}	<u>Stall Speed in landing configuration</u> (flaps and landing gear extended).
V _{S1}	<u>Stall speed in the given flap and landing gear configuration</u> .
V _{SSE}	<u>Recommended safe simulated OEI speed</u> is the minimum speed at which simulated OEI training operation should be executed.
V _X	<u>Best Angle-of-Climb Speed</u> is the speed which allows best ramp climb performances.
V _Y	<u>Best Rate-of-Climb Speed</u> is the speed which allows the best gain in altitude over a given time.
V _R	<u>Rotation speed</u> : is the speed at which the aircraft rotates about the pitch axis during takeoff
V _{YSE}	<u>Best Rate-of-Climb speed</u> in case of one engine inoperative.

Meteorological terminology

ISA	<u>International Standard Atmosphere</u> : is the air atmospheric standard condition at sea level, at 15°C (59°F) and at 1013.25hPa (29.92inHg).
QFE	<u>Official atmospheric pressure at airport level</u> : it indicates the aircraft absolute altitude with respect to the official airport level.
QNH	<u>Theoretical atmospheric pressure at sea level</u> : is the atmospheric pressure reported at the medium sea level, through the standard air pressure-altitude relationship, starting from the airport QFE.
OAT	<u>Outside Air Temperature</u> is the air static temperature expressed in degrees Celsius (°C).
T _S	<u>Standard Temperature</u> is 15°C at sea level pressure altitude and decreased by 2°C for each 1000 ft of altitude.
H _P	<u>Pressure Altitude</u> is the altitude read from an altimeter when the barometric subscale has been set to 1013 mb.

Aircraft performance and flight planning terminology

<i>Crosswind Velocity</i>	is the velocity of the crosswind component for the which adequate control of the airplane during takeoff and landing is assured.
<i>Usable fuel</i>	is the fuel available for flight planning.
<i>Unusable fuel</i>	is the quantity of fuel that cannot be safely used in flight.
<i>G</i>	is the acceleration of gravity.
<i>TOR</i>	is the takeoff distance measured from actual start to wheel liftoff point.
<i>TOD</i>	is total takeoff distance measured from start to 15m obstacle clearing.
<i>GR</i>	is the distance measured during landing from actual touchdown to stop point.
<i>LD</i>	is the distance measured during landing, from 15m obstacle clearing to actual stop.
<i>S/R</i>	is the specific range, that is the distance (in nautical miles) which can be expected at a specific power setting and/or flight configuration per kilogram of fuel used.

Weight and balance terminology

<i>Datum</i>	“Reference datum” is an imaginary vertical plane from which all horizontal distances are measured for balance purposes.
<i>Arm</i>	is the horizontal distance of an item measured from the reference datum.
<i>Moment</i>	is the product of the weight of an item multiplied by its arm.
<i>C.G.</i>	<u>Center of Gravity</u> is the point at which the airplane, or equipment, would balance if suspended. Its distance from the reference datum is found by dividing the total moment by the total weight of the aircraft.
<i>Standard Empty Weight</i>	is the weight of the aircraft with engine fluids and oil at operating levels.
<i>Basic Empty Weight</i>	is the standard empty weight to which it is added the optional equipment weight.
<i>Useful Load</i>	is the difference between maximum takeoff weight and the basic empty weight.
<i>Maximum Takeoff Weight</i>	is the maximum weight approved to perform the takeoff.
<i>Maximum Landing Weight</i>	is the maximum weight approved for the landing touchdown (for <i>P2006T</i> it is equivalent to the Maximum Takeoff Weight).

INTENTIONALLY LEFT BLANK

14. UNIT CONVERSION CHART

<i>MOLTIPLYING</i>		<i>BY</i> →	<i>YIELDS</i>	
TEMPERATURE				
Fahrenheit	[°F]	$\frac{5}{9} \cdot (F - 32)$	Celsius	[°C]
Celsius	[°C]	$(\frac{9}{5} \cdot C) + 32$	Fahrenheit	[°F]
FORCES				
Kilograms	[kg]	2.205	Pounds	[lbs]
Pounds	[lbs]	0.4536	Kilograms	[kg]
SPEED				
Meters per second	[m/s]	196.86	Feet per minute	[ft/min]
Feet per minute	[ft/min]	0.00508	Meters per second	[m/s]
Knots	[kts]	1.853	Kilometres / hour	[km/h]
Kilometres / hour	[km/h]	0.5396	Knots	[kts]
PRESSURE				
Atmosphere	[atm]	14.7	Pounds / sq. in	[psi]
Pounds / sq. in	[psi]	0.068	Atmosphere	[atm]
LENGTH				
Kilometres	[km]	0.5396	Nautical miles	[nm]
Nautical miles	[nm]	1.853	Kilometres	[km]
Meters	[m]	3.281	Feet	[ft]
Feet	[ft]	0.3048	Meters	[m]
Centimetres	[cm]	0.3937	Inches	[in]
Inches	[in]	2.540	Centimetres	[cm]
VOLUME				
Litres	[l]	0.2642	U.S. Gallons	[US Gal]
U.S. Gallons	[US Gal]	3.785	Litres	[l]
AREA				
Square meters	[m ²]	10.76	Square feet	[sq ft]
Square feet	[sq ft]	0.0929	Square meters	[m ²]

15. LITRES / US GALLONS CONVERSION CHART

Litres	US Gallons
5	1.3
10	2.6
15	4.0
20	5.3
25	6.6
30	7.9
35	9.2
40	10.6
45	11.9
50	13.2
60	15.9
70	18.5
80	21.1
90	23.8
100	26.4
110	29.1
120	31.7
130	34.3
140	37.7
150	39.6
160	42.3
170	44.9
180	47.6
190	50.2
200	52.8

US Gallons	Litres
1	3.8
2	7.6
3	11.4
4	15.1
6	22.7
8	30.3
10	37.9
12	45.4
14	53.0
16	60.6
18	68.1
20	75.7
22	83.3
24	90.9
26	98.4
28	106.0
30	113.6
32	121.1
34	128.7
36	136.3
38	143.8
40	151.4
45	170.3
50	189.3
55	208.2

INTENTIONALLY LEFT BLANK

INTENTIONALLY LEFT BLANK

SECTION 2 – LIMITATIONS

INDEX

1.	Introduction.....	3
2.	Speed limitations	5
3.	Airspeed indicator markings.....	7
4.	Powerplant limitations.....	9
5.	Lubricant	10
6.	Coolant liquid	10
7.	Propeller.....	10
8.	Governor	10
9.	Maximum operating altitude.....	11
10.	Ambient temperature	11
11.	Powerplant instruments markings.....	12
12.	Other instruments markings.....	12
13.	Warnings, cautions and advisories lights	13
14.	Weights	15
15.	Center of gravity range.....	17
16.	Approved maneuvers	19
17.	Maneuvers load factor limits.....	19
18.	Flight crew	19
19.	Flight conditions	20
20.	Fuel	20
21.	Limitations placards	21
21.1.	Speed limitations.....	21
21.2.	Operating limitations.....	22
21.3.	Inflight engine restart	23
21.4.	Baggage compartment capacity	23
21.5.	Engine oil level	24
21.6.	Fuel type	24
21.7.	Landing Gear Hydraulic System	25
21.8.	Rear seats.....	26
21.9.	Other placards.....	27
22.	Kinds of Operations Equipment List.....	29

INTENTIONALLY LEFT BLANK

1. INTRODUCTION

Section 2 includes operating limitations, instrument markings and basic placards necessary for safe operation of *P2006T* aircraft, its engines and standard systems and equipment.

This AFM Section is EASA approved.

INTENTIONALLY LEFT BLANK

2 SPEED LIMITATIONS

The following table addresses the airspeed limitations and their operational significance:

SPEED		KIAS	KCAS	REMARKS
V _{NE}	Never exceed speed	171	172	Do not exceed this speed in any operation.
V _{NO}	Maximum Structural Cruising Speed	138	136	Do not exceed this speed except in smooth air, and only with caution.
V _A	Design Manoeuvring speed	122	119	Do not make full or abrupt control movement above this speed, because under certain conditions the aircraft may be overstressed by full control movement.
V _O	Operating Manoeuvring speed			
V _{LE}	Maximum Landing Gear extended speed	93	93	Do not exceed this speed with the landing gear extended.
V _{LO}	Maximum Landing Gear operating speed	93	93	Do not exceed this speed when operating the landing gear.
V _{FE}	Maximum flaps extended speed	FULL	93	Do not exceed this speed for indicated flaps setting.
		T.O.	122	
V _{MC}	Aircraft minimum control speed with one engine inoperative	62	62	Do not reduce speed below this value in event of one engine inoperative condition.

INTENTIONALLY LEFT BLANK

3 AIRSPEED INDICATOR MARKINGS

Airspeed indicator markings and their colour code are explained in the following table.

MARKING	KIAS	EXPLANATION
White band	54-93	Lower limit is V_{SO} , upper limit is the maximum allowable speed with flaps extended in <i>FULL</i> position.
Red line	62	Minimum aircraft control speed with one engine inoperative and flaps set to T.O.
Green band	66-138	Normal aircraft operating range (lower limit is V_{S1} , stall speed in “clean” configuration, and upper limit is the maximum structural cruise speed V_{NO}).
Blue line	84	Best rate-of-climb speed with one engine inoperative at sea level.
Yellow band	138-171	Speed range where manoeuvres must be conducted with caution and only in smooth air.
Red line	171	Maximum speed for all operations.

INTENTIONALLY LEFT BLANK

4. POWERPLANT LIMITATIONS

Following table reports the operating limitations for both engines installed:

ENGINE MANUFACTURER: Bombardier Rotax GmbH.

ENGINE MODEL: 912 S3

MAXIMUM POWER:

	Max Power kW (hp)	Max rpm. Prop. rpm (engine)	Time max. (minutes)
Max. T.O.	73.5 (98.6)	2388 (5800)	5
Max. Cont.	69 (92.5)	2265 (5500)	-

Temperatures:

Max CHT*	135° C
Max CT	120° C
Min/Max Oil	50° C / 130° C
Oil normal operating range (approx.)	90° C / 110° C

- * *applicable for Engines up to serial no. 4924543(included) and repaired engine which doesn't change the cylinder head n°3 with new one (part no. 413195)*

Oil Pressure:

Minimum	0.8 Bar / 12psi	(below 1400 rpm prop)
Normal	2 – 5 Bar / 29-73psi	(above 1400 rpm prop)
Maximum	7 Bar / 102 psi	(above 1400 rpm prop)

Engine starting: allowable temperature range

OAT Min	-25° C
OAT Max	+50° C



In event of cold starting operation, it is permitted a maximum oil pressure of 7 bar for a short period.

Fuel pressure:

Minimum	2.2 psi (0.15 Bar)
Maximum	5.8 psi (0.40 Bar) or 7.26 psi* (0.5 Bar)

**only applicable for fuel pump part no. 893110 or 893114*

5. LUBRICANT

Use only oil with API classification “SG” or higher.

For additional info, refer to “Rotax Operators Manual” – last issue -, “Operating Media” Section.

6. COOLANT LIQUID

Refer to “Rotax Operators Manual” – last issue -, “Operating Media” Section.

7. PROPELLER

MANUFACTURER:	MT Propeller
MODEL:	MTV-21-A-C-F-/CF178-05
TYPE:	wood/composite 2-blade, variable pitch hydraulically controlled and fully featherable
DIAMETER:	1780 mm (no reduction is permitted)

8. GOVERNOR

MANUFACTURER:	MT Propeller
MODEL:	P-875-12
OPERATION:	Hydraulically controlled (oil pressure to reduce the pitch)

9. MAXIMUM OPERATING ALTITUDE

Maximum operating altitude is 14000 ft (4260 m) MSL.



CAUTION

At altitudes above 12500 ft (3810 m) up to and including 14000 ft (4260 m), flight must be limited to 30 minutes, unless the required minimum flight crew is provided with and uses supplemental oxygen for that part of the flight at those altitudes that is of more than 30 minutes duration.

10. AMBIENT TEMPERATURE

Ambient temperature: from -25°C to +50°C.



WARNING

Flight in expected and/or known icing conditions is forbidden.

11. POWERPLANT INSTRUMENTS MARKINGS

Powerplant instrument markings and their colour code significance are shown below:

INSTRUMENT		RED LINE Minimum limit	GREEN ARC Normal operating	YELLOW ARC Caution	RED LINE Maximum limit
Propeller	rpm	----	580 - 2265	2265 - 2388	2388
Oil temp.	°C	50	90 - 110	50 - 90 110 - 130	130
CT	°C	----	50 - 120	----	120
CHT ¹	°C	----	50 - 135	----	135
Oil pressure	bar	0.8	2 - 5	0.8 - 2 5 - 7 ⁽²⁾	7
Fuel press.	psi	2.2	2.2 - 5.8 or 7.2 ³	----	5.8 or 7.2 ³
Fuel Q.ty	litres	0 ⁽⁴⁾	----	----	----

12. OTHER INSTRUMENTS MARKINGS

INSTRUMENT	RED LINE Minimum limit	GREEN ARC Normal operating	YELLOW ARC Caution	RED LINE Maximum limit
Voltmeter	10,5 Volt	12 - 14 Volt	----	----

1 applicable for Engines up to serial no. 4924543(included) and repaired engine which doesn't change the cylinder head n°3 with new one (part no. 413195)

2- In event of cold starting operation, it is permitted a maximum oil pressure of 7 bar for a short period.

3- only applicable for fuel pump part no. 893110 or 893114

4 - "0" indication shows the unusable fuel quantity (2,8 litres for each fuel tank).

13 Warning/caution alerts and safe operating annunciations

Following table addresses the warning and caution alerts and safe operating annunciations shown (unless differently specified) on the Annunciation Window:

Warning alert (RED)	Cause
L BUS VOLT HIGH	LH electric system overvoltage
R BUS VOLT HIGH	RH electric system overvoltage
L COOLANT LOW	Left engine - coolant liquid low level
L COOLANT LOW	Right engine - coolant liquid low level
PILOT DR OPEN	Main door open and/or unlocked
REAR DR OPEN	Rear door open and/or unlocked
LH ENGINE FIRE	Left engine compartment: fire detected
RH ENGINE FIRE	Right engine compartment: fire detected
LG TRANSITION (warning light installed near the landing gear control lever)	One or more legs are in transition phase and/or the selected retracted/extended position is not yet reached.
Caution alert (AMBER)	Cause
L ALT FAIL	LH generator failure
R ALT FAIL	RH generator failure
PITOT HEAT	Pitot heating system failure/not activated
EXT POWER ON	External electrical supply connected
GEAR PUMP ON	LG pump electrically supplied
Safe operating annunciation (GREEN)	Indication
L FUEL PUMP ON	Left engine - electrical fuel pump ON
R FUEL PUMP ON	Right engine - electrical fuel pump ON
PITOT HEAT ON	Pitot heating system ON
LG Down & Locked (3 advisory lights, one for each leg, installed near the landing gear control lever)	Landing gear extended and locked

Aural means are provided by Garmin G950 System: a repeating tone is associated to the warning alerts and a single chime is associated to the caution alerts. Safe operating annunciations do not have any aural chime generated.

Make reference to Garmin G950 Pilot's Guide for P2006T, last issue, "Annunciations and alerts" (Appendix A).

14 WEIGHTS

Condition	Weight	
Maximum takeoff weight	1230 kg	2712 lb
Maximum landing weight	1230 kg	2712 lb
Maximum zero wing fuel weight	1195 kg	2635 lb

NOTE

Refer to Para. 21.4 of this AFM Section for baggage loading limitations.

INTENTIONALLY LEFT BLANK

15. CENTER OF GRAVITY RANGE

Datum	Vertical plane tangent to the wing leading edge (the aircraft must be levelled in the longitudinal plane)
Levelling	Refer to the seat track supporting beams (see procedure in Section 6)
Forward limit	0.221 m (16.5% MAC) aft of datum for all weights
Aft limit	0.415 m (31% MAC) aft of datum for all weights



The pilot is responsible for ensuring that the airplane is properly loaded. Refer to Section 6 for appropriate instructions.

INTENTIONALLY LEFT BLANK

16. APPROVED MANEUVERS

The aircraft is certified in normal category in accordance with EASA CS-23 regulation.

Non aerobatic operations include:

- Any manoeuvre pertaining to “normal” flight
- Stalls (except whip stalls)
- Lazy eights
- Turns in which the angle of bank is not more than 60°
- Chandelle



Acrobatic manoeuvres, including spins and turns with angle of bank of more than 60°, are not approved for such a category. In addition, stall with one engine inoperative is forbidden.



Limit load factor could be exceeded by moving flight controls to maximum deflection at a speed above $V_A=V_O$ (118 KIAS, Manoeuvring Speed).

17. MANEUVERS LOAD FACTOR LIMITS

Maneuver load factors limits are as follows:

Positive	Negative
+ 3.8 g	- 1.78 g

Maneuver load factors limits with flaps extended are as follows:

Positive	Negative
+ 2 g	0 g

18. FLIGHT CREW

Minimum crew:	1 pilot
Maximum number of occupants:	4 people (including the pilot)

19. FLIGHT CONDITIONS

The aircraft can be equipped for following flight operations (make reference to Para. 22 concerning the equipment list required on board to allow them):

- VFR Day and Night
- IFR Day and Night including IMC



Flight in expected and/or known icing conditions, in proximity of storms or in turbulence is forbidden.



Additional equipment can be required to fulfil national or specific operational requirements. The owner is responsible for fulfilling these requirements.



Equipment list is addressed in Section 6.

20. FUEL

2 TANKS:	100 litres each one (26,42 US gallons)
MAXIMUM CAPACITY:	200 litres (52,8 US gallons)
MAXIMUM USABLE FUEL:	194.4 litres (51,35 US gallons)
APPROVED FUEL:	MOGAS ASTM D4814
	MOGAS EN 228 Super/Super plus (min. RON 95)
	AVGAS 100 LL (ASTM D910)



Prolonged use of Aviation Fuel Avgas 100LL results in greater wear of valve seats and greater combustion deposits inside cylinders due to higher lead content. It is therefore suggested to avoid using this type of fuel unless strictly necessary. Make reference to Rotax Maintenance Manual which prescribes dedicated checks due to the prolonged use of Avgas.

21. LIMITATIONS PLACARDS

Hereinafter the placards, related to the operating limitations and installed on *P2006T*, are reported.

21.1. SPEED LIMITATIONS

On the left side instrument panel, the following placards reporting the speed limitations are placed:

Operating Manoeuvring speed
 $V_o = 122\text{KIAS}$

Maximum L.G. op. speed
 $V_{LO} / V_{LE} = 93\text{KIAS}$

Speed limitations placard for MTOW @1230 kg (2712 lb)

21.2. OPERATING LIMITATIONS

On the instrument panel, it is placed the following placard reminding the observance of aircraft operating limitations; make reference to Para. 22 for the list of equipment required on board to allow flight operations in VFR Day, VFR Night, IFR Day and IFR Night conditions.

This A/C can be operated only in normal category DAY-NIGHT-VFR-IFR (with required equipment) in non-icing conditions. All aerobatics manoeuvres including spinning are prohibited. For operational limitations refer to FLIGHT MANUAL

21.3. INFLIGHT ENGINE RESTART

The inflight engine restart procedure is reported on a placard (shown below) installed on the central console.

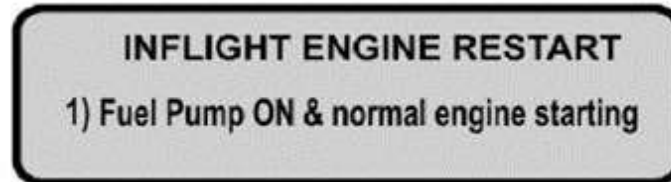

21.4. BAGGAGE COMPARTMENT CAPACITY

The placard shown below, and installed on the baggage compartment (vertical panel), concerns the baggage compartment load limitations herein reported:

- Maximum allowable load: 80kg/176lb
- Maximum intensity of loading: 0.9 kg/dm² – 19 lbs/sqft



21.5. ENGINE OIL LEVEL

On the engine nacelle, in correspondence of the engine oil reservoir access door, it is located the following placard addressing the limitations concerning the oil level, the oil volume and the oil type.



**USE ONLY OIL WITH API
CLASSIFICATION SG OR HIGHER**

21.6. FUEL TYPE

In correspondence of each fuel tank filler cap, it is located the following placard reporting the approved fuel type and the tank usable fuel.



OR



21.7. LANDING GEAR HYDRAULIC SYSTEM

The placard shown below, and located on the tail cone, concerns the allowed low pressure limit for the landing gear emergency accumulator.

The low pressure limit is **20 bar**.

If during pre-flight inspection the value is below **20 bar**, the system must be re-charged by means of the override button (see Section 7, Para. 9).

EMERGENCY OIL TANK PRESS

LOW PRESSURE LIMIT

20 BAR







21.8. REAR SEATS

During Taxi, Take OFF, Landing (including Emergency Landing), both rear seats must be kept in the lowest and full aft position.

The following placard is located aside both rear seats.

Rear seats must be kept in lowest and full aft position during Taxi, Take Off, Landing and Emergency Landing

21.9. OTHER PLACARDS

Description	Placard	Place
Smoking ban		Instruments panel, right side
Ditching emergency exit: opening instructions		Ditching emergency exit handle: internal side
Ditching emergency exit: opening instructions		Ditching emergency exit handle: external side
Door locking system: bypass instructions		Main door and emergency exit: external side
Door locking system: bypass instructions		Main door and emergency exit: internal side
Main door: exit instructions		Main door, internal side
Emergency exit label		Emergency exit: internal and external side

INTENTIONALLY LEFT BLANK

22. KINDS OF OPERATIONS EQUIPMENT LIST

This paragraph reports the KOEL table, concerning the equipment list required on board under CS-23 regulations to allow flight operations in VFR Day, VFR Night, IFR Day and IFR Night conditions.

Flight in VFR Day and Night, IFR Day and Night is permitted only if the prescribed equipment is installed and operational.

Additional equipment, or a different equipment list, for the intended operation may be required by national operational requirements and also depends on the route to be flown.

Equipment	VFR Day	VFR Night	IFR Day	IFR Night
Magnetic compass	•	•	•	•
GDU 1040 - Display Unit (2)	•	•	•	•
GIA 63W - Integrated Avionics Unit (2)	•	•	•	•
GDC 74A - Air Data Computer	•	•	•	•
GTP 59 - OAT sensor	•	•	•	•
GRS 77 - AHRS	•	•	•	•
GMU 44 - Magnetometer	•	•	•	•
GMA 1347 - Audio panel/Marker beacon	•	•	•	•
GTX 33 - Transponder	•	•	•	•
Standby Airspeed indicator	•	•	•	•
Standby Attitude indicator (electric)	•	•	•	•
Standby Altimeter	•	•	•	•
Pitot heating system	•	•	•	•
Clock	•	•	•	•
Breakers panels	•	•	•	•
First Aid kit	•	•	•	•
Fire extinguisher	•	•	•	•
Fire detectors (2)	•	•	•	•
Instruments lights	•	•	•	•
Position lights	•	•	•	•
Landing light	•	•	•	•
Taxi light	•	•	•	•
Strobe lights	•	•	•	•
Torch		•	•	•
Cabin light		•	•	•
Cockpit lights		•	•	•
Emergency light	•	•	•	•
Volt-Ammeter	•	•	•	•
LG position and transition lights	•	•	•	•
ELT	•	•	•	•
Alternate static source	•	•	•	•
MAP indicator (dual)	•	•	•	•
RPM indicator (2)	•	•	•	•
Oil pressure indicator (2)	•	•	•	•
Oil temperature indicator (2)	•	•	•	•
CHT (2)	•	•	•	•
Fuel pressure indicator (2)	•	•	•	•
Fuel quantity indicator (2)	•	•	•	•
Longitudinal trim indicator	•	•	•	•
Rudder trim indicator	•	•	•	•
Flaps position indicator	•	•	•	•
Stall warning system	•	•	•	•
DME			•	•
ADF			•	•
	VFR Day	VFR Night	IFR Day	IFR Night

INTENTIONALLY LEFT BLANK

INTENTIONALLY LEFT BLANK

SECTION 3 – EMERGENCY PROCEDURES**INDEX**

1. INTRODUCTION	3
1.1. Engine failure during takeoff run.....	3
2. Airplane alerts	6
2.1 Single alternator failure / overvoltage.....	7
2.2 Both alternators failure	8
2.3 Both alternators overvoltage	9
2.4 Failed door closure	10
2.5 Pitot heating system failure	11
2.6 Coolant liquid low level	12
2.7 Gear Pump failure	13
2.8 Engine fire.....	14
2.9 Loss of information displayed	15
2.10 Loss of airspeed information	15
2.10 Loss of attitude information	16
2.11 Loss of altitude information	16
2.12 Loss of vertical speed information.....	17
2.13 Loss of heading information	17
2.14 Display failure	19
3. ENGINE SECURING	21
4. POWERPLANT EMERGENCIES	23
4.1 Propeller overspeeding.....	23
4.2 CHT limit exceedance	24
4.3 Oil temperature limit exceedance	25
4.4 Oil pressure limits exceedance.....	26
4.5 Low fuel pressure	27
5. Other emergencies	29
5.1 Emergency descent	29
5.2 Total electrical failure.....	29
5.3 Static ports failure.....	30
5.4 Unintentional flight into icing conditions.....	31
5.5 Carburettor icing.....	32
5.6 Flaps control failure	33
6 ONE ENGINE INOPERATIVE PROCEDURES.....	34
6.1 Characteristic airspeeds with one engine inoperative.....	35
6.2 Inflight engine restart.....	36
6.3 Engine failure during takeoff run.....	37
6.4 Engine failure during climb.....	39
6.5 Engine failure in flight	40
6.6 One engine inoperative landing.....	41



7 LANDING GEAR SYSTEM FAILURES..... 42

7.1 Emergency landing gear extension..... 42

7.2 Complete Gear up or nose gear up landing..... 43

7.3 Partial Main LG extension 45

7.4 Failed retraction 47

7.5 Unintentional landing gear extension 47

8 SMOKE AND FIRE OCCURRENCE 49

8.1 Engine fire on the ground 49

8.2 Engine fire during takeoff run..... 50

8.3 Engine fire in flight 52

8.4 Electrical smoke in cabin on the ground 52

8.5 Electrical smoke in cabin during flight 53

9 UNINTENTIONAL SPIN RECOVERY 55

10 LANDING EMERGENCIES..... 56

10.1 Landing without engine power 56

10.2 Landing with Nose landing gear tire deflated 58

10.3 Landing with a known main landing gear tire deflated 59

10.4 Landing without brakes 60

11 AIRCRAFT EVACUATION 61

12 DITCHING..... 62

1. INTRODUCTION

Section 3 includes checklists and detailed procedures for coping with various types of emergency conditions that could arise after a system failure.

Before operating the aircraft, the pilot should become thoroughly familiar with this manual and, in particular, with this Section. Further on a continued and appropriate training and self study should be done.

Two types of emergency procedures are hereby given.

- a. “BOLD FACES” which must be known by heart by the pilot and executed, in the correct and complete sequence, immediately after the failure is detected and confirmed.

These procedures characters are boxed and highlighted:

1.1. ENGINE FAILURE DURING TAKEOFF RUN

BEFORE ROTATION: ABORT TAKE OFF

- | | | |
|----|-----------------------|------------------------------------|
| 1. | Throttle Lever | <i>BOTH IDLE</i> |
| 2. | Rudder | <i>Keep heading control</i> |
| 3. | -- | |
| 4. | -- | |

- b. “other procedures” which should be well theoretically known and mastered, but that can be executed entering and following step by step the AFM current section appropriate checklist.

Additionally operating the aircraft, the pilot should become thoroughly familiar with the Garmin G950 Pilot’s Guide for Tecnam P2006T (P/N 190-01146-XX) – last issue - and, in particular, with the present AFM Section.



Garmin G950 Pilot’s Guide for Tecnam P2006T (P/N 190-01146-XX) – last issue - must be carried onboard the airplane at all times.



Garmin G950 has a very high degree of functional integrity. However, the pilot must recognize that providing monitoring and/or self-test capability for all conceivable system failures is not practical. Although unlikely, it may be possible for erroneous operation to occur without a fault indication shown by the G950. It is thus the responsibility of the pilot to detect such an occurrence by means of crosschecking with all redundant or correlated information available in the cockpit.

In any case, as a failure or abnormal behaviour is detected pilots should act as follows:

- 1. Keep self-control and maintain aircraft flight attitude and parameters*
- 2. Analyse the situation identifying, if required, the area for a possible emergency landing*
- 3. Apply the pertinent procedure*
- 4. Inform the Air Traffic Control as applicable*

NOTE

For the safe conduct of later flights, any anomaly and/or failure must be communicated to the National Authorities in charge, in order to put the aircraft in a fully operational and safe condition.

NOTE

In this Chapter, following definitions apply:

Land as soon as possible: land without delay at the nearest suitable area at which a safe approach and landing is assured.

Land as soon as practical: land at the nearest approved landing area where suitable repairs can be made.

INTENTIONALLY LEFT BLANK

2. AIRPLANE ALERTS

Annunciation Window, located to the right of the Altimeter and Vertical Speed Indicator, supplies 16 alerts for warnings and cautions along with safe operating annunciations. The colours are as follows:

- GREEN:** to indicate that pertinent device is turned ON
AMBER: to indicate no-hazard situations which have to be considered and which require a proper crew action
RED: to indicate emergency conditions

Warning alert text is shown in red in the Annunciation Window and is accompanied by a continuous chime and a flashing WARNING Softkey annunciation. Selecting the WARNING Softkey acknowledges the presence of the warning alert and stops the aural chime.

Caution alert text is shown in yellow in the Annunciation Window and is accompanied by a single chime and a flashing CAUTION Softkey annunciation. Selecting the CAUTION Softkey acknowledges the presence of the caution alert. Caution voice alerts repeat three times or until acknowledged by selecting the CAUTION Softkey.

All aircraft annunciations can be displayed simultaneously in the Annunciation Window. A white horizontal line separates annunciations that are acknowledged from annunciations that are not yet acknowledged. Higher priority annunciations are displayed towards the top of the window.

In order to give a short description about the airplane alerts, text messages are displayed on the Alerts Window: pressing the ALERTS Softkey displays the Alerts Window, pressing the ALERTS Softkey a second time removes the Alerts Window from the display. When the Alerts Window is displayed, the FMS knob can be used to scroll through the alert message list.

2.1 SINGLE ALTERNATOR FAILURE / OVERVOLTAGE

Annunciation window	Alert window
L ALT FAIL	Lh Alternator
OR	
R ALT FAIL	Rh Alternator

1. FIELD LH (or RH) OFF
2. FIELD LH (or RH) ON

If the LH (or RH) ALT caution stays displayed

3. FIELD LH (or RH) OFF
4. Avionic LH OFF
5. ADF OFF

NOTE

*Switching OFF avionic LH and ADF will permit to shed non-essential electrical power.
The battery and a single generator are able to supply the electrical power necessary for flight, but redundancy is lost.*

If conditions permit:

NOTE

Switching CROSS BUS OFF will further reduce alternator load; the decision mainly depends on weather conditions.

6. CROSS BUS LH (or RH) OFF

Equipment will be lost accordingly to the following table:

LH Gen Bus	LH Avionic Bus	RH Avionic Bus	RH Gen Bus
Pitot Heat	DME	ADF	NAV Lights
Landing Light	Transponder	COM 2	Rudder Trim
Taxi Light	A/P	NAV 2	Stall Warning
	A/P Pitch Trim	MFD	
		AHRS/ADC*	

* AHRS /ADC are fed from battery bus if Mod 2006/135 is embodied

7. Land as soon as practicable

2.2 BOTH ALTERNATORS FAILURE

Annunciation window	Alert window
L ALT FAIL	Lh Alternator
R ALT FAIL	Rh Alternator

In event of both L and R ALT FAIL caution alerts displayed:

1. FIELD LH and RH *BOTH OFF*
2. FIELD LH and RH *BOTH ON*

If the LH (or RH) ALT caution stays displayed

1. Verify good ammeter indications on restored alternator
2. Refer to Single alternator failure / overvoltage drill (Para 2.1)

If both LH and RH ALT cautions stay displayed

3. FIELD LH and RH *BOTH OFF*
4. CROSS BUS LH and RH *BOTH OFF*

If engine starting battery modification is applied

5. EMERG BATT switch ON
6. Land as soon as possible.

If engine starting battery modification is not applied

5. Land as soon as possible.

Equipment will be lost accordingly to the following table:

LH Gen Bus	LH Avionic Bus	RH Avionic Bus	RH Gen Bus
Pitot Heat	DME	ADF	NAV Lights
Landing Light	Transponder	COM 2	Rudder Trim
Taxi Light	A/P	NAV 2	Stall Warning
	A/P Pitch Trim	MFD	
		AHRS/ADC*	

AHRS /ADC are fed from battery bus if Mod 2006/135 is embodied

NOTE

The battery can supply electrical power for at least 30 minutes.

2.3 BOTH ALTERNATORS OVERVOLTAGE

Annunciation window	Alert window
L BUS VOLT HIGH	Lh overvoltage
R BUS VOLT HIGH	Rh overvoltage

In event of both L and R BUS VOLT HIGH warning alerts displayed:

1. FIELD LH and RH *BOTH OFF*
2. FIELD LH and RH *BOTH ON (one at a time)*

If the LH (or RH) BUS VOLT HIGH warning is still displayed

3. Verify good ammeter indications on restored alternator
4. Refer to Single alternator failure / overvoltage drill (Para 2.1)

If both LH and RH BUS VOLT HIGH warning are still displayed

3. CROSS BUS LH and RH BOTH OFF
4. FIELD LH and RH BOTH OFF
5. FIELD LH and RH BOTH ON (one at a time)

If LH (or RH) BUS VOLT HIGH warning is still displayed

6. Verify good ammeter indications on restored alternator
7. Switch CROSS BUS on the restored alternator side
8. Refer to Single alternator failure / overvoltage drill (Para 2.1)

If both LH and RH BUS VOLT HIGH warning are still displayed

6. FIELD LH and RH *BOTH OFF*

If engine starting battery modification is applied

7. EMERG BATT switch ON
8. **Land as soon as possible.**

If engine starting battery modification is not applied

7. **Land as soon as possible**

Equipment will be lost accordingly to the following table:

LH Gen Bus	LH Avionic Bus	RH Avionic Bus	RH Gen Bus
Pitot Heat	DME	ADF	NAV Lights
Landing Light	Transponder	COM 2	Rudder Trim
Taxi Light	A/P	NAV 2	Stall Warning
	A/P Pitch Trim	MFD	
		AHRS/ADC*	

AHRS /ADC are fed from battery bus if Mod 2006/135 is embodied

NOTE

The battery can supply electrical power for at least 30 minutes.

2.4 FAILED DOOR CLOSURE

Annunciation window	Alert window
PILOT DR OPEN	Main door open
OR	
REAR DR OPEN	Rear door open

In case of door opening / unlocking, related PILOT or REAR DR OPEN alert is displayed. In this case, apply following procedure:

ON THE GROUND

1. Passengers and crew seat belts *Fasten and tighten*
2. Affected door *Verify correctly closed*

If door is open

3. Relevant engine *Shut down*
4. Affected door *Close and check*

If door is closed

3. Locking device *Check*

If down in unlocked position

4. Abort mission.

IN FLIGHT

1. Passengers and crew seat belts *Fasten and tighten*
2. Affected door and locked device *Verify correctly closed*

If door is open or locking device is unlocked

3. Land as soon as possible

2.5 PITOT HEATING SYSTEM FAILURE

Annunciation window	Alert window
PITOT HEAT ON	Pitot heat
PITOT HEAT	Pitot heat

When the Pitot Heating system is activated, the green PITOT HEAT advisory light is turned ON.

If the amber PITOT HEAT caution light turns OFF, then the Pitot Heating system is functioning properly. Anytime the amber PITOT HEAT caution light is ON at the same time the green PITOT HEAT light is ON, then the Pitot Heating system is not functioning properly.

1. Pitot heat switch *OFF*
2. Verify Pitot Heating circuit breaker is IN
3. Pitot heat switch *ON*
4. Check PITOT HEAT caution light:

If the amber light stays ON, assume a failure in the pitot heating system.
Avoid visible moisture and OATs below 10 deg C.

2.6 COOLANT LIQUID LOW LEVEL

Annunciation window	Alert window
L COOLANT LOW	Lh Low Coolant
OR	
R COOLANT LOW	Rh Low Coolant

When the engine coolant liquid level goes under the lower limit, the related L or R COOLANT LOW warning alert is displayed. Low coolant level condition may lead to high CHT/CT. When the warning is displayed, apply following procedure:

1. Check affected engine CHT/CT

If CHT is above 135°C or CT is above 120°C

2. Affected engine *Reduce power setting to reduce CHT/CT up to the minimum practical*
3. **Land as soon as practical**

If CH/CT continues to rise and engine shows roughness or power loss

4. Affected engine *SECURE (securing procedure on Para. 4)*
5. **Land as soon as possible** applying *one engine inoperative landing procedure*. See Para. 6.6

2.7 GEAR PUMP FAILURE

Annunciation window	Alert window
GEAR PUMP ON	Gear powered

The GEAR PUMP ON caution light turns ON when the landing gear hydraulic pump is electrically supplied.

After the landing gear retraction, if the red TRANS light turns OFF and the GEAR PUMP ON caution stays turned ON, this could indicate a gear pump relay failure to ON.

If TRANS light is OFF

1. Continue the mission monitoring the caution light.

If TRANS light is ON

2. Landing gear is not locked in UP position

NOTE

The electrical gear pump, continuously supplied, causes a current absorption which does not affect the mission unless this failure is coupled with the overall electrical failure. In this case, the residual battery endurance may be consistently lower than 30 minutes.

2.8 ENGINE FIRE

Annunciation window	Alert window
LH ENGINE FIRE	Left engine fire detected

OR

RH ENGINE FIRE	Right engine fire detected
-----------------------	----------------------------

In event of engine fire, the LH or RH ENGINE FIRE warning alert is displayed.
Refer to following procedures:

FIRE ON THE GROUND:	see Para. 8.1
FIRE DURING TAKEOFF RUN:	see Para. 8.2
FIRE IN FLIGHT:	see Para. 8.3

2.9 LOSS OF INFORMATION DISPLAYED

When a LRU or a LRU function fails, a large red ‘X’ is typically displayed on the display field associated with the failed data.

NOTE

In most of cases, the red “X” annunciation is accompanied by a message advisory alert issuing a flashing ADVISORY Softkey annunciation which, once selected, acknowledges the presence of the message advisory alert and displays the alert text message in the Alerts Window. Refer to G950 Pilot’s Guide for Tecnam P2006T (P/N 190-01146-00), last issue, Appendix A, Message Advisories list.

2.10 LOSS OF AIRSPEED INFORMATION

	<p>AIRSPEED FAIL (RED X ON DISPLAY FIELD)</p>
	<p>Display system is not receiving airspeed input from the Air Data Computer.</p>

INSTRUCTION: revert to standby analogical airspeed indicator

2.10 LOSS OF ATTITUDE INFORMATION

	<p>ATTITUDE FAIL (RED X ON DISPLAY FIELD)</p>
	<p>Display system is not receiving attitude information from the AHRS.</p>

INSTRUCTION: revert to standby analogical attitude indicator

2.11 LOSS OF ALTITUDE INFORMATION

	<p>ALTITUDE FAIL (RED X ON DISPLAY FIELD)</p>
	<p>Display system is not receiving altitude input from the Air Data Computer.</p>

INSTRUCTION: revert to standby analogical altitude indicator

2.12 LOSS OF VERTICAL SPEED INFORMATION

	<p>VERT SPEED FAIL (RED X ON DISPLAY FIELD)</p>
	<p>Display system is not receiving vertical speed input from the Air Data Computer.</p>

INSTRUCTION: determine vertical speed on the basis of altitude information

2.13 LOSS OF HEADING INFORMATION

	<p>HDG (RED X ON DISPLAY FIELD)</p>
	<p>Display system is not receiving valid heading input from AHRS.</p>

INSTRUCTION: revert to magnetic compass

INTENTIONALLY LEFT BLANK

2.14 DISPLAY FAILURE

In the event of a display failure, the G950 System automatically switches to reversionary (backup) mode. In reversionary mode, all important flight information is presented on the remaining display in the same format as in normal operating mode. The change to backup paths is completely automated for all LRUs and no pilot action is required.

if the system fails to detect a display problem

1. DISPLAY BACKUP button

PUSH



If a display fails, the related Integrated Avionics Unit (IAU) is cut off and can no longer communicate with the remaining display: consequently the NAV and COM functions provided to the failed display by the Integrated Avionics Unit are flagged as invalid on the remaining display.

INTENTIONALLY LEFT BLANK

3. ENGINE SECURING

Following procedure is applicable to shut-down one engine in flight:

- | | |
|--------------------------------|------------------------|
| 1. Throttle Lever | <i>IDLE</i> |
| 2. Ignition | <i>BOTH OFF</i> |
| 3. Propeller Lever | <i>FEATHER</i> |
| 4. Fuel Selector | <i>OFF</i> |
| 5. Electrical fuel pump | <i>OFF</i> |

After securing engine(s), after analysing situation, refer immediately to following procedures:

ENGINE FAILURE IN FLIGHT:	see Para. 6.5
SINGLE GENERATOR FAILURE:	see Para. 2.1
or BOTH GENERATOR FAILURE:	see Para. 2.2
INFLIGHT ENGINE RESTART:	see Para. 6.2
ONE ENGINE INOPERATIVE LANDING:	see Para. 6.6
or LANDING WITHOUT ENGINE POWER:	see Para. 10.1

INTENTIONALLY LEFT BLANK

4. POWERPLANT EMERGENCIES

4.1 PROPELLER OVERSPEEDING

The aircraft is fitted with propeller/governor set by MT-Propeller such a way that the maximum propeller rpm exceedance is prevented. In case of propeller overspeeding in flight, apply following procedure:

- | | |
|--------------------|---|
| 1. Throttle Lever | <i>REDUCE power to minimum practical</i> |
| 2. Propeller Lever | <i>REDUCE as practical (<u>not in feathering</u>)</i> |
| 3. RPM indicator | <i>CHECK</i> |

If it is not possible to decrease propeller rpm, apply *engine securing procedure* (see Para. 3) and **land as soon as possible** applying *one engine inoperative landing procedure* (See Para. 6.6).



Maximum propeller rpm exceedance may cause the engine components damage. Propeller and engine shall be inspected in accordance with related Operators Manuals.

4.2 CHT LIMIT EXCEEDANCE

If CHT/CT exceeds its limit, apply following procedure:

1. Check affected engine CHT/CT

If CHT is above 135°C or CT is above 120°C

2. Affected engine *Reduce power setting to reduce CHT/CT up to the minimum practical*
3. **Land as soon as practical**

If CHT/CT continues to rise and engine shows roughness or power loss

4. Affected engine *SECURE (securing procedure on Para. 3)*
5. **Land as soon as possible** applying one engine inoperative landing procedure. See Para. 6.6

4.3 OIL TEMPERATURE LIMIT EXCEEDANCE

If oil temperature exceeds maximum limit (130°C):

1. OIL PRESS *CHECK*

If oil pressure is within limits

2. Affected engine *Reduce power setting to minimum applicable*
3. Affected engine *Keep propeller speed higher than 2000 RPM*

If oil pressure does not decrease

4. Airspeed *INCREASE*

NOTE

If oil temperature does not come back within limits, the thermostatic valve, regulating the oil flow to the heat exchangers, could be damaged or an oil leakage can be present in the oil supply line.

5. **Land as soon as practical** keeping the affected engine to the minimum necessary power
6. Monitor OIL PRESS and CHT/CT

if engine roughness / vibrations or erratic behaviour is detected:

7. Affected engine *SECURE (engine securing procedure on Para. 3)*
8. **Land as soon as possible** applying *one engine inoperative landing procedure*. See Para. 6.6



Excessive oil pressure drop leads to a high pitch propeller configuration with consequent propeller feathering and engine stopping.

4.4 OIL PRESSURE LIMITS EXCEEDANCE

If oil pressure exceeds its lower or upper limit (0.8 – 7 bar), apply following procedure:



Excessive oil pressure drop leads to a high pitch propeller configuration with consequent propeller feathering and engine stopping.

NOTE

An excessive oil pressure value can be counteracted by decreasing propeller rpm.

1. OIL PRESS *CHECK*

If oil pressure exceeds upper limit (7 bar)

2. Throttle Lever *first REDUCE affected engine power by 10%*
3. Propeller Lever *Keep low rpm*
4. OIL PRESS *CHECK (verify if came back within the limits)*
5. **Land as soon as practical**

If oil pressure is under the lower limit (0.8 bar)

2. **Land as soon as practical**

If oil pressure is continuously decreasing

3. **Affected engine** *SECURE (see engine securing procedure on Para. 3)*
4. **Land as soon as possible** applying one engine inoperative landing procedure.
See Para. 6.6

4.5 LOW FUEL PRESSURE

If fuel pressure decreases below the lower limit (2.2 psi), apply following procedure:

- | | |
|---------------------|----------------|
| 1. Fuel press | <i>CHECK</i> |
| 2. Fuel quantity | <i>CHECK</i> |
| 3. Fuel consumption | <i>MONITOR</i> |

If a fuel leakage is deemed likely

5. **Land as soon as possible.**

If a fuel leakage can be excluded:

- | | |
|---|-----------|
| 4. Electrical fuel pump | <i>ON</i> |
| 5. Feed the affected engine by means of opposite side fuel tank | |

If pressure does not come back within the limits

6. **Land as soon as practical**

INTENTIONALLY LEFT BLANK

5. OTHER EMERGENCIES

5.1 EMERGENCY DESCENT



CAUTION

Descent with airspeed at VLE, idle power and gear down will provide high descent rates and pitch attitudes up to -15°.

Anticipate altitude capture and return to level flight during emergency descent in order to assure a safe and smooth recovery from maneuver.

- | | |
|-----------------|----------------------|
| 1. Power levers | <i>IDLE</i> |
| 2. Flaps | <i>UP</i> |
| 3. IAS | <i>below VLO/VLE</i> |
| 4. Landing gear | <i>DOWN</i> |
| 5. Airspeed | <i>Up to VLE</i> |

5.2 TOTAL ELECTRICAL FAILURE

In case of electrical system overall failure, apply following procedure:

- | | |
|--------------------|------------------------|
| 1. Emergency light | <i>ON if necessary</i> |
| 2. MASTER SWITCH | <i>OFF</i> |
| 3. FIELD LH and RH | <i>BOTH OFF</i> |
| 4. MASTER SWITCH | <i>ON</i> |
| 5. FIELD LH and RH | <i>BOTH ON</i> |

If failure persists

- | | |
|--|--|
| 9. EMERG BATT switch | <i>ON (if engine starting battery installed)</i> |
| 10. Land as soon as possible applying <i>emergency landing gear extension</i> procedure (see Para. 7.1) | |



WARNING

An electrical system overall failure prevents flaps operation: landing distance without flaps increases of about 25%.



CAUTION

A fully charged battery can supply electrical power for at least 30 minutes.

5.3 STATIC PORTS FAILURE

In case of static ports failure, the alternate static port in the cabin (shown below) must be activated.



- | | |
|--------------------------------|-------------------------------|
| 1. Cabin ventilation | <i>OFF (hot and cold air)</i> |
| 2. ALTERNATE STATIC PORT VALVE | <i>OPEN</i> |
| 3. Continue the mission | |

5.4 UNINTENTIONAL FLIGHT INTO ICING CONDITIONS

1. Carburettor heat *BOTH ON*
2. Pitot heat *ON*
3. Fly as soon as practical toward a zone clear of visible moisture, precipitation and with higher temperature, changing altitude and/or direction.
4. Control surfaces *Move continuously to avoid locking*
5. Propellers rpm *INCREASE to prevent ice build-up on the blades*



WARNING

In event of ice build-up in correspondence of wing leading edges, stall speed increases.



WARNING

Ice build-up on wing, tail fin or flight control surfaces unexpected sudden roll and/or pitch tendencies can be experienced and may lead to unusual attitude and loss of aircraft control.



WARNING

Do not use Autopilot when icing formation is suspected or detected.

5.5 CARBURETTOR ICING

DURING TAKEOFF

The carburettor icing in “full throttle” mode is unlikely.

Take off in known or suspected icing formation is forbidden; in order to dispose of full engine take off power, take-off must be performed with carburettor heating OFF.

IN FLIGHT

Carburettor icing is considered probable when external air temperature is below 15° C and visible air moisture (clouds, mist, haze or fog) or atmospheric precipitation are present.

Generally, an OAT-to-dew point temperature spread lower than 10°C and OAT less than 15°C with visibility lower than 5 km is a positive indication of likely icing formation condition.

Should an inadvertent flight into known or forecast icing condition happen carburettor heating should be selected “ON” as soon as possible: the greater the advance carburettors are warmed the better the chances not to form ice and avoid engine power loss or reduction.

Keep Carb Heating “ON” until engine power is restored and area of possible icing condition is exited.



CAUTION

Carburettor Heating selected to “ON” will cause engine RPM reduction of about 100 RPM causing a sensible available engine power decrease.

5.6 FLAPS CONTROL FAILURE

DURING TAKEOFF



CAUTION

Flap UP take off, requires a T/O distance (50 ft height obstacle distance) increased by about 20%.

1. Airspeed *Keep below 93 KIAS*
2. **Land as soon as practical**

DURING APPROACH/LANDING



CAUTION

If the flaps control fails, consider the higher stall speed (see Section 5, Para. 6, "Stall Speed") and an increased landing distance of about 25%.

1. Airspeed *Keep over 75 KIAS*
2. **Land as soon as practical** on a runway of appropriate length

6 ONE ENGINE INOPERATIVE PROCEDURES



CAUTION

The ineffectiveness of one engine results in asymmetric traction which tends to yaw and bank the aircraft towards the inoperative engine. In this condition it is essential to maintain the direction of flight compensating the lower traction and counteracting the yawing effects by means of rudder pedals. To improve directional control, it is advisable to bank the aircraft of about 5° to the side of the operating engine.

In addition, reduced available overall power and extended control surfaces will lead to a performance drop: a quick pitch attitude reduction will allow to keep a minimum safety airspeed.

The higher is the airspeed the better will be lateral and directional control efficiency: never allow airspeed to drop below V_{MCA} .



CAUTION

Best residual climb performances in OEI (One Engine Inoperative) condition have been recorded in Flap Up configuration and at V_{YSE} , which is marked as a Blue Line on the Airspeed indicator (calculated for maximum Take Off Weight and Sea, Level ISA condition) For actual condition V_{YSE} refer to Section 5 Para. 13, “One engine rate of climb”.

V_{XSE} is actually very close to V_{YSE} in any condition, thus best climb performance will also be associated with best climb angle (gradient) performance. Refer to Section 5 Para. 14, One-Engine Rate of Climb at V_{XSE} , for relevant data.

6.1 CHARACTERISTIC AIRSPEEDS WITH ONE ENGINE INOPERATIVE

In case of one engine inoperative condition (OEI), pilot shall take into account the airspeeds shown below:

Conditions	Speed (KIAS)	
	Minimum aircraft control speed with one engine inoperative and flaps set to T.O. (V_{MC})	62
Best rate-of-climb speed OEI (V_{YSE})	MTOW 1180 kg	MTOW 1230 kg
	80	84
Best gradient speed OEI (V_{XSE})	79	83

NOTE

Reference is made to MTOW, 1180 kg and 1230 kg, at Sea Level and ISA condition (if Supplement G10- Increased MTOW @1230 KG - is applicable).

6.2 INFLIGHT ENGINE RESTART

After:



WARNING

- *mechanical engine seizure;*
- *fire;*
- *major propeller damage*

engine restart is not recommended.

- | | |
|------------------------------------|--|
| 1. Carburettor heat | <i>ON if required</i> |
| 2. Electrical fuel pump | <i>ON</i> |
| 3. Fuel quantity indicator | <i>CHECK</i> |
| 4. Fuel Selector | <i>CHECK (Crossfeed if required)</i> |
| 5. FIELD | <i>OFF</i> |
| 6. Ignition | <i>BOTH ON</i> |
| 7. Operating engine Throttle Lever | <i>SET as practical</i> |
| 8. Stopped engine Throttle Lever | <i>IDLE</i> |
| 9. Stopped engine Propeller Lever | <i>FULL FORWARD</i> |
| 10. Start push-button | <i>PUSH</i> |
| 11. Propeller Lever | <i>SET at desired rpm</i> |
| 12. FIELD | <i>ON (check for positive ammeter)</i> |
| 13. Engine throttle levers | <i>SET as required</i> |

If engine restart is unsuccessful

- | | |
|-------------------------------------|---|
| 14. EMERG BATT switch | <i>ON (if starting battery installed)</i> |
| 15. Repeat engine restart procedure | |



CAUTION

After engine restart, if practical, moderate propeller rpm and throttle increase to allow OIL and CHT/CT temperatures for stabilizing in the green arcs.

NOTE

If the fuel quantity in the tank which feeds the stopped engine is low, select the opposite side fuel tank by means of the fuel selector.

If engine restart is still unsuccessful:

- | | |
|--|---|
| 16. Affected engine | <i>SECURE (see engine securing procedure Para. 3)</i> |
| 17. Land as soon as possible applying one engine inoperative landing procedure. See Para. 6.6 | |

6.3 ENGINE FAILURE DURING TAKEOFF RUN

BEFORE ROTATION: ABORT TAKE OFF

- | | |
|--------------------------|------------------------------------|
| 1. Throttle Lever | <i>BOTH IDLE</i> |
| 2. Rudder | <i>Keep heading control</i> |
| 3. Brakes | <i>As required</i> |

When safely stopped:

- | | |
|---------------------------------------|-----------------|
| 4. Failed Engine Ignition | BOTH OFF |
| 5. Failed Engine Field | OFF |
| 6. Failed Engine Electrical fuel pump | OFF |

IF THE DECISION IS TAKEN TO CONTINUE THE TAKEOFF:

A take-off abort should always be preferred if a safe stop can be performed on ground.

A suggested "GO-NO-GO" criteria is: abort take-off until LG is still down and locked.

Once airborne accelerate to Blue Line Speed (V_{YSE}) before commanding LG retraction.

Take-off planning should take into account that high density altitude and aircraft mass may result in OEI negative climb rate.

V_{YSE} with flap up shall be flown in order to achieve best possible rate of climb after landing gear retraction and engine feathering.



- | | |
|---|---|
| 1. Operating engine Throttle Lever | <i>FULL POWER</i> |
| 2. Operating engine Propeller Lever | <i>FULL FORWARD</i> |
| 3. Heading | <i>Keep control using rudder and ailerons</i> |
| 4. Attitude | <i>Reduce as appropriate to keep airspeed over 62 KIAS</i> |
| 5. <u>Inoperative engine Propeller Lever</u> | <i>FEATHER</i> |
| 6. Landing gear control lever | <i>UP</i> |
| 7. Airspeed | <i>V_{XSE}/V_{YSE} as required</i> |
| 8. Flaps | <i>0°</i> |

At safe altitude

- | | | |
|-----|---------------------------------------|--|
| 9. | <u>Inoperative engine</u> | <i>Confirm and SECURE</i> |
| 10. | Operative engine Electrical fuel pump | <i>Check ON</i> |
| 11. | Operating engine | <i>Check engine instruments</i> |
| 12. | Operating engine Fuel Selector | <i>Check correct feeding (crossfeed if needed)</i> |

If engine restart is recommended:

13. Apply INFLIGHT ENGINE RESTART procedure *see Para 6.2*

If engine restart is unsuccessful or it is not recommended:

13. **Land as soon as possible**
14. One engine inoperative landing procedure. *see Para. 6.6*

WARNING

Following:

- *mechanical engine seizure;*
 - *fire;*
 - *major propeller damage*
- engine restart is not recommended.*

6.4 ENGINE FAILURE DURING CLIMB

- | | |
|--|--|
| 1. Autopilot | OFF |
| 2. Heading | <i>Keep control using rudder and ailerons</i> |
| 3. Attitude | <i>Reduce as appropriate to keep airspeed over 62 KIAS</i> |
| | |
| 4. Operating engine Throttle Lever | <i>FULL THROTTLE</i> |
| 5. Operating engine Propeller Lever | <i>FULL FORWARD</i> |
| 6. Operative engine Electrical fuel pump | <i>Check ON</i> |
| 7. <u>Inoperative engine</u> Propeller Lever | <i>FEATHER</i> |
| 8. <u>Inoperative engine</u> | Confirm and <i>SECURE</i> |

If engine restart is possible:

9. Apply INFLIGHT ENGINE RESTART procedure *see Para 6.2*

If engine restart is unsuccessful or it is not recommended:

9. **Land as soon as possible**
10. One engine inoperative landing procedure. *see Para. 6.6*



Following a mechanical engine seizure, fire or a major propeller damage engine restart is not recommended.



Continuation of flight to a safe landing runway must be planned taking into account maximum operating ceiling in OEI condition. Refer to Section 5 Para 1, "One-engine rate of climb".

6.5 ENGINE FAILURE IN FLIGHT

- | | |
|--------------|--|
| 1. Autopilot | OFF |
| 2. Heading | <i>Keep control using rudder and ailerons</i> |
| 3. Attitude | <i>Adjust as appropriate to keep airspeed over 62 KIAS</i> |

- | | |
|--|--|
| 4. Operating engine | <i>Monitor engine instruments</i> |
| 5. Operative engine Electrical fuel pump | <i>Check ON</i> |
| 6. Operating engine Fuel Selector | <i>Check correct feeding
(crossfeed if needed)</i> |

If engine restart is possible:

- | | |
|--|---------------------|
| 7. Apply INFLIGHT ENGINE RESTART procedure | <i>see Para 6.2</i> |
|--|---------------------|

If engine restart is unsuccessful or it is not recommended:

- | | |
|--|----------------------|
| 8. Land as soon as possible | |
| 9. One engine inoperative landing procedure. | <i>see Para. 6.6</i> |



Following a mechanical engine seizure, fire or a major propeller damage engine restart is not recommended.



Continuation of flight to a safe landing runway must be planned taking into account maximum operating ceiling in OEI condition. Refer to Section 5 Para 12. Rate of climb with One Engine Inoperative.

6.6 ONE ENGINE INOPERATIVE LANDING



Thoroughly evaluate residual Single Engine Go-Around capabilities and expected climb gradient should a Missed Approach / balked landing be executed.

Refer to Section 5, Para. Single engine go around/Balked landing/climb and Para. 13 and 14- One-engine Rate of Climb at V_{YSE} and V_{XSE}



Autopilot must be kept OFF

- | | |
|--|--|
| 1. Seat belts | <i>Tightly fastened</i> |
| 2. Landing lights | <i>As required</i> |
| 3. Operating engine Fuel Selector | <i>Check correct feeding/crossfeed if needed</i> |
| 4. <u>Inoperative engine</u> Propeller Lever | <i>CHECK FEATHER</i> |
| 5. <u>Inoperative engine</u> | <i>CHECK SECURED</i> |
| 6. Operative engine Electrical fuel pump | <i>ON</i> |

When on final leg:

- | | |
|----------------------|--|
| 7. Flap | <i>T/O</i> |
| 8. Landing gear | <i>Select DOWN and check three green lights on</i> |
| 9. Approach Airspeed | <i>V_{YSE}</i> |
| 10. Touchdown speed | <i>70 KIAS</i> |

7 LANDING GEAR SYSTEM FAILURES

7.1 EMERGENCY LANDING GEAR EXTENSION

NOTE

Landing gear extension failure is identified by means of the green lights not illuminated: relevant gear leg may not be fully extended and/or locked.

Light bulb operating status can be verified by pressing the LDG push-to-test button. Additionally, the red light TRANS indicates that one or more legs are moving and the PUMP ON amber light on the annunciator panel indicates the hydraulic gear pump is operating.

- | | | |
|----|--------------------------------------|------------------------------------|
| 1. | Airspeed | <i>below applicable VLO/VLE</i> |
| 2. | Landing gear control lever | <i>DOWN</i> |
| 3. | Emergency gear extension access door | <i>REMOVE</i> |
| 4. | RH control lever | <i>ROTATE 90° counterclockwise</i> |
| 5. | Wait at least 20 seconds | |

NOTE

Main Landing Gear legs green lights may be turned on, thus indicating effective main gear legs blocked in down position by mere effect of gravity force.

- | | | |
|----|----------------------------------|-------------------------------------|
| 6. | LH control lever | <i>ROTATE 180° counterclockwise</i> |
| 7. | Land as soon as practical | |



NOTE

The emergency landing gear extension operation takes about 20- sec.

7.2 COMPLETE GEAR UP OR NOSE GEAR UP LANDING



The following procedure applies if Nose Landing Gear is not extended and locked even after emergency extension procedure.



A Nose Landing Gear up leg not down and locked might lead to a hazardous situation, especially on uneven runways.



If landing gear position is not known, perform a tower fly-by at safe speed and altitude to have confirmation about its situation.

If possible coordinate fire brigade intervention along runway and report number of persons on board and remaining fuel type and quantity.

If a complete Landing Gear up or a Nose Landing Gear up position is reported:

Preparation

1. Reduce fuel load if time and conditions permit
2. Crew and passengers safety belts *Tightly fastened*
3. Landing gear control lever *UP*
4. Green lights and TRANS light *CHECK OFF*
5. Flap setting *plan approach with Flap Land*

Before ground contact:

6. LH and RH Fuel Selector *BOTH OFF*
7. LH and RH Electrical fuel pump *BOTH OFF*
8. Ignitions *ALL OFF*

On touch down:

9. Landing attitude *slight nose-up and wings levelled,*
10. Touchdown speed *as low as 50 KIAS with flap*
11. Aircraft nose *gently lower as speed bleeds off*

After aircraft stops:

12. FIELD LH and RH *BOTH OFF*
13. MASTER SWITCH *OFF*



Master switch to OFF impairs radio communication and outside aircraft lighting.

14. Aircraft Evacuation

carry out if necessary



Consider use of ditching emergency exit to escape in case pilot or passenger doors are blocked, watch for engine hot parts, fuel, hydraulic fluid or oil spills. Leave aircraft in upwind direction.

7.3 PARTIAL MAIN LG EXTENSION



The following procedure applies if one or both Main Landing Gear legs are not completely extended and locked even after emergency extension procedure.



A partial gear landing (RH and/or LH leg not down and locked) might turn into a hazardous situation, especially on uneven runways.

If possible try to obtain a symmetric gear extension (e.g. by trying further landing gear retraction) in order to avoid swerving after touchdown. A gear up landing is generally considered safer.



If landing gear position is not known, perform a tower fly-by at safe speed and altitude to have confirmation about its situation.

If possible coordinate fire brigade intervention along runway and report number of persons on board and remaining fuel type and quantity.

Preparation

- | | |
|---|-------------------------------------|
| 1. Reduce fuel load if time and conditions permit | |
| 2. Crew and passengers safety belts | <i>Tightly fastened</i> |
| 3. Landing gear control lever | <i>UP</i> |
| 4. Green lights and TRANS light | <i>CHECK OFF</i> |
| 5. Flap setting | <i>plan approach with Flap Land</i> |

If partially extended landing gear is confirmed:

Before ground contact:

- | | |
|-----------------------------------|-----------------|
| 6. LH and RH Fuel Selector | <i>BOTH OFF</i> |
| 7. LH and RH Electrical fuel pump | <i>BOTH OFF</i> |
| 8. Ignitions | <i>ALL OFF</i> |

On touch down:

- | | |
|---------------------------|--|
| 9. Align for approach | <i>on the runway centreline</i> |
| 10. Touchdown speed | <i>as low as 50 KIAS</i> |
| 11. Touchdown | <i>on the extended gear only</i> |
| 12. Heading and direction | <i>maintain applying appropriate aileron and rudder/steering control</i> |
| 13. Retracted leg | <i>keep off the ground as long as possible</i> |

After aircraft stops:

- | | |
|---------------------|-----------------|
| 14. FIELD LH and RH | <i>BOTH OFF</i> |
| 15. MASTER SWITCH | <i>OFF</i> |



Master switch to OFF impairs radio communication and outside aircraft lighting.

- | | |
|-------------------------|-------------------------------|
| 16. Aircraft Evacuation | <i>carry out if necessary</i> |
|-------------------------|-------------------------------|



Consider use of ditching emergency exit to escape in case pilot or passenger doors are blocked, watch for engine hot parts, fuel, hydraulic fluid or oil spills. Leave aircraft in upwind direction.

7.4 FAILED RETRACTION

- | | | |
|----|----------------------------|--------------------------------------|
| 1. | Airspeed | <i>Keep below applicable VLO/VLE</i> |
| 2. | Landing gear control lever | <i>DOWN</i> |



A Landing Gear lever recycle (further retraction attempt) may result in a final partial Landing Gear Extension, which may then compromise safe landing aircraft capability.

- | | | |
|----|---------------------|--------------|
| 3. | Landing Gear lights | <i>Check</i> |
|----|---------------------|--------------|

If a safe landing configuration is obtained (3 greens)

- | | | |
|----|---------------|--|
| 4. | Land normally | |
|----|---------------|--|

If a safe landing gear configuration is not obtained:

- | | | |
|----|----------------------------------|------------------------------|
| 4. | Emergency LG extension procedure | <i>Apply (See Para. 7.1)</i> |
| 5. | Land as soon as practical | |

7.5 UNINTENTIONAL LANDING GEAR EXTENSION



An unwanted landing gear extension, with at least one leg moving downward, may be caused by hydraulic fluid loss and it is signaled by

- *significant aerodynamic noise increase;*
- *light and counteractable nose down pitch moment;*
- *red TRANS light turned on.*

- | | | |
|----|----------------------------|--------------------------------------|
| 1. | Airspeed | <i>Keep below applicable VLO/VLE</i> |
| 2. | Landing gear control lever | <i>DOWN</i> |
| 3. | Landing Gear lights | <i>Check</i> |

If a safe landing configuration is obtained (3 greens)

- | | | |
|----|---------------|--|
| 4. | Land normally | |
|----|---------------|--|

If a safe landing gear configuration is not obtained:

- | | | |
|----|----------------------------------|------------------------------|
| 4. | Emergency LG extension procedure | <i>Apply (See Para. 7.1)</i> |
| 5. | Land as soon as practical | |

INTENTIONALLY LEFT BLANK

8 SMOKE AND FIRE OCCURRENCE

8.1 ENGINE FIRE ON THE GROUND

- | | |
|---------------------------|------------------------------|
| 1. Fuel Selectors | <i>BOTH OFF</i> |
| 2. Ignitions | <i>ALL OFF</i> |
| 3. Electrical fuel pumps | <i>BOTH OFF</i> |
| 4. Cabin heat and defrost | <i>OFF</i> |
| 5. MASTER SWITCH | <i>OFF</i> |
| 6. Parking Brake | <i>ENGAGED</i> |
| 7. Aircraft Evacuation | carry out immediately |



Consider use of ditching emergency exit to escape in case pilot or passenger doors are blocked, watch for engine hot parts, fuel, hydraulic fluid or oil spills. Leave aircraft in upwind direction.

8.2 ENGINE FIRE DURING TAKEOFF RUN

BEFORE ROTATION: ABORT TAKE OFF

- | | |
|--------------------------|-----------------------------|
| 1. Throttle Lever | BOTH IDLE |
| 2. Rudder | <i>Keep heading control</i> |
| 3. Brakes | <i>As required</i> |

With aircraft under control

- | | |
|----------------------------------|------------------------------|
| 4. Fuel Selector | BOTH OFF |
| 5. Ignitions | ALL OFF |
| 6. Electrical fuel pump | BOTH OFF |
| 7. Cabin heat and defrost | OFF |
| 8. MASTER SWITCH | OFF |
| 9. Parking Brake | ENGAGED |
| 10. Aircraft Evacuation | <i>carry out immediately</i> |



Consider use of ditching emergency exit to escape in case pilot or passenger doors are blocked, watch for engine hot parts, fuel, hydraulic fluid or oil spills. Leave aircraft in upwind direction.

IF THE DECISION IS TAKEN TO CONTINUE THE TAKEOFF:

A take-off abort should always be preferred if a safe stop can be performed on ground.

A suggested "GO-NO-GO" criteria is: abort take-off until LG is still down and locked.



Once airborne accelerate to Blue Line Speed (V_{YSE}) before commanding LG retraction.

Take-off planning should take into account that high density altitude and aircraft mass may result in OEI negative climb rate.

V_{YSE} with flap up shall be flown in order to achieve best possible rate of climb after landing gear retraction and engine feathering.

- | | |
|---|--|
| 1. Operating engine Throttle Lever | FULL POWER |
| 2. Operating engine Propeller Lever | FULL FORWARD |
| 3. Heading | <i>Keep control using rudder and ailerons</i> |
| 4. Attitude | <i>Reduce as appropriate to keep airspeed over 62 KIAS</i> |
| 5. <u>Fire affected engine Propeller Lever</u> | FEATHER |
| 6. Landing gear control lever | UP |
| 7. Airspeed | <i>V_{XSE}/V_{YSE} as required</i> |
| 8. Flaps | 0° |

At safe altitude

- | | | |
|-----|--|-----------------------------|
| 9. | Cabin heat and defrost | <i>BOTH OFF</i> |
| 10. | <u>Fire affected engine</u> Fuel Selector | <i>Confirm and OFF</i> |
| 11. | <u>Fire affected engine</u> Ignitions | <i>Confirm and BOTH OFF</i> |
| 12. | <u>Fire affected engine</u> Electrical fuel pump | <i>Confirm and OFF</i> |
| 13. | <u>Fire affected engine</u> FIELD | <i>OFF</i> |
| 14. | Land as soon as possible applying <i>one engine inoperative landing</i> procedure.
See Para. 6.6 | |

8.3 ENGINE FIRE IN FLIGHT

- | | |
|---|--|
| 1. Cabin heat and defrost | <i>BOTH OFF</i> |
| 2. Autopilot | <i>OFF</i> |
| 3. <u>Fire affected engine</u> Fuel Selector | <i>Confirm and OFF</i> |
| 4. <u>Fire affected engine</u> Ignition | <i>Confirm and BOTH OFF</i> |
| 5. <u>Fire affected engine</u> Throttle Lever | <i>Confirm and FULL FORWARD</i> |
| 6. <u>Fire affected engine</u> Propeller Lever | <i>Confirm and FEATHER</i> |
| 7. <u>Fire affected engine</u> Electrical fuel pump | <i>OFF</i> |
| 8. Heading | <i>Keep control using rudder and ailerons</i> |
| 9. Attitude | <i>Adjust as appropriate to keep airspeed over 62 KIAS</i> |
| 10. <u>Fire affected engine</u> Field | <i>OFF</i> |
| 11. Cabin ventilation | <i>OPEN</i> |
| 12. Land as soon as possible applying <i>one engine inoperative</i> landing procedure.
See Para. 6.6 | |

8.4 ELECTRICAL SMOKE IN CABIN ON THE GROUND

- | | |
|---------------------------|------------------------------|
| 1. MASTER SWITCH | <i>OFF</i> |
| 2. Cabin heat and defrost | <i>OFF</i> |
| 3. Throttle Lever | <i>BOTH IDLE</i> |
| 4. Ignitions | <i>ALL OFF</i> |
| 5. Fuel Selector | <i>BOTH OFF</i> |
| 6. Parking Brake | <i>ENGAGED</i> |
| 7. Aircraft Evacuation | <i>carry out immediately</i> |



Consider use of ditching emergency exit to escape in case pilot or passenger doors are blocked, watch for engine hot parts, fuel, hydraulic fluid or oil spills. Leave aircraft in upwind direction.

8.5 ELECTRICAL SMOKE IN CABIN DURING FLIGHT

- | | |
|--|-------------|
| 1. Cabin ventilation | <i>OPEN</i> |
| 2. Emergency light | <i>ON</i> |
| 3. Standby attitude indicator switch | <i>ON</i> |
| 4. Gain VMC conditions as soon as possible | |

In case of cockpit fire:

- | | |
|----------------------|----------------------------------|
| 5. Fire extinguisher | <i>use toward base of flames</i> |
|----------------------|----------------------------------|



CAUTION

A tripped circuit breaker should not be reset.

If smoke persists, shed electrical supply in order to isolate faulty source by:

- | | |
|------------------------|-----------------|
| 6. FIELD LH and RH | <i>OFF</i> |
| 7. AVIONICS LH and RH | <i>OFF</i> |
| 8. CROSS BUS LH and RH | <i>BOTH OFF</i> |



CAUTION

A fully charged battery can supply electrical power for at least 30 minutes.

If faulty source is found:

9. It may be possible to restore non faulty power sources (one at a time)

If smoke persists:



WARNING

Before total electrical system shutdown consider gaining VMC condition, at night set personal emergency light on.

Only emergency light and emergency ADI will be electrically powered.

All radio COM and NAV, Landing Gear lever (normal mode) and indication lights, electrical trims and flaps will be unserviceable.

- | | |
|------------------------------|------------|
| 10. MASTER SWITCH | <i>OFF</i> |
| 11. Land as soon as possible | |

When on ground:

12. Aircraft Evacuation

carry out as necessary



Consider use of ditching emergency exit to escape in case pilot or passenger doors are blocked, watch for engine hot parts, fuel, hydraulic fluid or oil spills. Leave aircraft in upwind direction.

9 UNINTENTIONAL SPIN RECOVERY



Spin behaviour has not been demonstrated since certification process does not required it for this aircraft category.

Intentional spin is forbidden.

Stall with one engine inoperative is forbidden.

Should an unintentional spin occur, the classic recovery manoeuvre is deemed as being the best action to undertake:

- | | |
|----------------------------------|--|
| 1. Both engines throttles | <i>idle</i> |
| 2. Flight Controls | <i>centralize</i> |
| 3. Rudder | <i>fully against rotation until it stops</i> |

10 LANDING EMERGENCIES

10.1 LANDING WITHOUT ENGINE POWER

In case of double engine failure both propellers should be feathered to achieve maximum efficiency. Best glide speed is attained with flap UP and equals V_Y for current aircraft mass and air density altitude. Refer to Section 5, Para. "Enroute Rate of Climb".



Normal landing gear extension requires MASTER switch ON, an efficient battery and takes around 20 seconds.

LG selection should be appropriately anticipated when sure on final.

Flap can be set to T/O or LAND when sure on final to reduce landing ground roll on short field.

Touchdown speed can be as low as 50 kt with flap down.

1. Airspeed

MTOW 1180kg	MTOW 1230 kg
$V_Y = 83$ KIAS	$V_Y = 84$ KIAS

2. Flaps *UP*
3. Emergency landing field *Select*



Emergency landing strip should be chosen considering surface condition, length and obstacles. Wind can be guessed by smoke plumes direction and tree tops or grass bending. Select touchdown direction according to the furrows of a plowed field, not across.

4. Safety belts *FASTEN and tighten*
5. Flaps *Set when landing is assured*
6. Landing gear control lever *DOWN when landing is assured*



To reduce landing gear extension time, evaluate use of emergency control system which requires about 12 sec.

Before touch down

- | | |
|-------------------------|-----------------|
| 7. Fuel Selector | <i>BOTH OFF</i> |
| 8. Electrical fuel pump | <i>BOTH OFF</i> |
| 9. Ignitions | <i>ALL OFF</i> |
| 10. MASTER SWITCH | <i>OFF</i> |

When stopped

- | | |
|-------------------------|-------------------------------|
| 11. Aircraft Evacuation | <i>carry out if necessary</i> |
|-------------------------|-------------------------------|



Consider use of ditching emergency exit to escape in case pilot or passenger doors are blocked, watch for engine hot parts, fuel, hydraulic fluid or oil spills. Leave aircraft in upwind direction.

10.2 LANDING WITH NOSE LANDING GEAR TIRE DEFLATED



If possible, as a nose landing gear flat tire condition is known, coordinate fire brigade intervention along runway and report number of persons on board and remaining fuel type and quantity.

If Nose Landing Gear flat tire is confirmed:

Preparation

- | | |
|-------------------------------------|--|
| 1. Crew and passengers safety belts | <i>Tightly fastened</i> |
| 2. If time permits | <i>Burn fuel to lower landing weight</i> |
| 3. Flap setting | <i>plan approach with Flap Land</i> |

Before ground contact:

- | | |
|-------------------------|-----------------|
| 4. Fuel Selector | <i>BOTH OFF</i> |
| 5. Electrical fuel pump | <i>BOTH OFF</i> |
| 6. Ignitions | <i>ALL OFF</i> |

On touch down:

- | | |
|---------------------|---|
| 7. Landing attitude | <i>slight nose-up and wings levelled,</i> |
| 8. Touchdown speed | <i>as low as 50 KIAS with flap</i> |
| 9. Aircraft nose | <i>gently lower as speed bleeds off</i> |

After aircraft stops:

- | | |
|---------------------|-----------------|
| 10. FIELD LH and RH | <i>BOTH OFF</i> |
| 11. MASTER SWITCH | <i>OFF</i> |



Master switch to OFF impairs radio communication and outside aircraft lighting.

- | | |
|-------------------------|-------------------------------|
| 12. Aircraft Evacuation | <i>carry out if necessary</i> |
|-------------------------|-------------------------------|



Consider use of ditching emergency exit to escape in case pilot or passenger doors are blocked, watch for engine hot parts, fuel, hydraulic fluid or oil spills. Leave aircraft in upwind direction.

10.3 LANDING WITH A KNOWN MAIN LANDING GEAR TIRE DEFLATED



An asymmetrical landing gear tire condition (RH and/or LH tires deflated) might turn into a hazardous situation, especially on uneven runways.



If possible, as a landing gear tires condition is known, coordinate fire brigade intervention along runway and report number of persons on board and remaining fuel type and quantity.

If a main Landing Gear flat tire is confirmed:

Preparation

- | | |
|-------------------------------------|-------------------------------------|
| 1. Crew and passengers safety belts | <i>Tightly fastened</i> |
| 2. Flap setting | <i>plan approach with Flap Land</i> |

Before ground contact:

- | | |
|-----------------------------------|-----------------|
| 3. Ignitions | <i>ALL OFF</i> |
| 4. LH and RH Fuel Selector | <i>BOTH OFF</i> |
| 5. LH and RH Electrical fuel pump | <i>BOTH OFF</i> |

On touch down:

- | | |
|--------------------------|--|
| 6. Align for approach | <i>on the runway centreline</i> |
| 7. Touchdown speed | <i>as low as 50 KIAS</i> |
| 8. Touchdown | <i>on the good tire gear only</i> |
| 9. Heading and direction | <i>maintain applying appropriate aileron and rudder/steering control</i> |
| 10. Flattened tire | <i>keep off the ground as long as possible</i> |

After aircraft stops (or if runway departure is imminent):

- | | |
|---------------------|-----------------|
| 11. FIELD LH and RH | <i>BOTH OFF</i> |
| 12. MASTER SWITCH | <i>OFF</i> |



Master switch to OFF impairs radio communication and outside aircraft lighting.

- | | |
|-------------------------|-------------------------------|
| 13. Aircraft Evacuation | <i>carry out if necessary</i> |
|-------------------------|-------------------------------|



Consider use of ditching emergency exit to escape in case pilot or passenger doors are blocked, watch for engine hot parts, fuel, hydraulic fluid or oil spills. Leave aircraft in upwind direction.

10.4 LANDING WITHOUT BRAKES



If possible, select an airport with suitable runway length.

Otherwise, evaluate the possibility to perform a gear up landing (refer to procedure reported on Para. 7.2). In the latter case consider the increasing hazard of an uneven pavement.

- | | |
|-----------------|---------------|
| 1. Safety belts | <i>FASTEN</i> |
|-----------------|---------------|

After touch down if runway is deemed insufficient to decelerate:

- | | |
|--------------------------|-----------------|
| 2. Fuel Selector | <i>BOTH OFF</i> |
| 3. Electrical fuel pumps | <i>BOTH OFF</i> |
| 4. Ignitions | <i>ALL OFF</i> |
| 5. FIELD LH and RH | <i>BOTH OFF</i> |
| 6. MASTER SWITCH | <i>OFF</i> |



Master switch to OFF impairs radio communication and outside aircraft lighting.

Before end of runway or if runway departure is imminent:

- | | |
|-------------------------------|-----------|
| 7. Landing gear control lever | <i>UP</i> |
|-------------------------------|-----------|

After aircraft stops:

- | | |
|------------------------|-------------------------------|
| 8. Aircraft Evacuation | <i>carry out if necessary</i> |
|------------------------|-------------------------------|



Consider use of ditching emergency exit to escape in case pilot or passenger doors are blocked, watch for engine hot parts, fuel, hydraulic fluid or oil spills. Leave aircraft in upwind direction.

11 AIRCRAFT EVACUATION



Leave the aircraft when engines are fully stopped. Watch for engine hot parts and fuel, hydraulic fluid or oil spills when using fuselage doors. If fuselage doors are unserviceable escape through the ditching emergency exit

In case of engine fire escape from opposite or upwind aircraft side.

Verify (if not yet performed):

- | | |
|--|------------------------|
| 1. Fuel Selectors | <i>BOTH OFF</i> |
| 2. Ignitions | <i>ALL OFF</i> |
| 3. Electrical fuel pumps | <i>BOTH OFF</i> |
| 4. MASTER SWITCH | <i>OFF</i> |
| 5. Parking Brake | <i>ENGAGED</i> |
| 6. Leave the aircraft using emergency exits | |

12 DITCHING

Contact with water shall happen with aircraft longitudinal axis and direction of motion parallel to the wave at the minimum possible speed. Keep the nose up as long as possible.



Once in the water, the aircraft shall be evacuated through the ditching emergency exit, if available put life vest on and set dinghy out first. Inflate them only outside the aircraft.

If available, try to approach any existing ship in the vicinity in order to be rapidly located and rescued right after ditching.

- | | |
|-----------------|-----------------------------|
| 1. Landing gear | <i>UP</i> |
| 2. Safety belts | <i>Tighten and fastened</i> |
| 3. Flaps | <i>FULL</i> |

Before water impact

- | | |
|-------------------------|-----------------|
| 4. Fuel Selector | <i>BOTH OFF</i> |
| 5. Electrical fuel pump | <i>BOTH OFF</i> |
| 6. Ignitions | <i>ALL OFF</i> |
| 7. MASTER SWITCH | <i>OFF</i> |
| 8. FIELD LH and RH | <i>BOTH OFF</i> |
| 9. Impact speed | <i>50 KIAS</i> |

Aircraft evacuation

- | | |
|---------------------------|-------------------------|
| 10. Emergency exit handle | <i>rotate clockwise</i> |
| 11. Latch door | <i>push outward</i> |
| 12. Life vests | <i>don</i> |
| 13. Evacuate the aircraft | |

INTENTIONALLY LEFT BLANK

SECTION 4 – NORMAL PROCEDURES

INDEX

1. INTRODUCTION	3
1.1. Normal ops general recommendations	3
2. AIRSPEEDS	7
1.2. Normal operations	7
1.3. Single engine training.....	8
3. Normal procedures checklist	9
3.1 Recommendations for cold weather operations.....	9
3.2 Pre-flight check – aircraft walk-around.....	11
3.3 Cockpit inspections.....	17
3.4 Engine starting	20
3.5 Before taxiing	22
3.6 Taxiing	22
3.7 Prior to takeoff.....	23
3.8 Line-up	24
3.9 Takeoff and climb	25
3.10Cruise.....	26
3.11Turbulent air operation.....	26
3.12Descent and approach.....	27
3.13Before landing.....	27
3.14Balked landing/missed approach	28
3.15After landing	28
3.16Parking/shut down	29
3.17Postflight checks.....	30
4. Ground towing, parking and mooring	31
4.1. Towing	31
4.2. Parking.....	31
4.3. Mooring	32

INTENTIONALLY LEFT BLANK

1. INTRODUCTION

Section 4 describes checklists and recommended procedures for the conduct of normal operations for *P2006T* aircraft.

1.1. NORMAL OPS GENERAL RECOMMENDATIONS

The following points should be always brought to attention to pilot/instructor/operator when operating a Tecnam aircraft equipped with variable pitch propeller:

1. **Propeller governor ground check:** during the ground check of governor, as prescribed by the propeller/governor manufacturer, the drop should not be above 600/650 prop RPM. The aim of this ground check is to confirm governor efficiency, not the complete feathering function.

Especially during the first cycle of prop lever pulling, the governor tendency is to respond to the input with consistent delay (causing the pilot to continue retarding the prop lever until a sudden and abrupt RPM change is observed).

This causes an excessive drop in propeller speed which, in some cases, may reach up to 800 RPM and, consequently, a drop of up to 2000 engine shaft rpm. The long term result is a major wear of engine gearbox, bushings and pistons and, in some cases, may result in detonation. In order to avoid these long term adverse effects, ground check of governor should be performed by slowly and gently retarding the prop lever until a drop a drop from 1650 to 1100 rpm is displayed on prop rpm indicator. The purging cycle should be repeated up to 4 times, with the governor closely (firmly and positively) control the rpm.

- *during governor ground check, drop shall not exceed 600 propeller rpm*
- *pilot shall be ready to push the prop lever if drop of >550rpm is recorded during check*

2. **Power changes:** When power setting changes are required in any flight condition, remember the following correct procedure:

- **Power increase = FIRST Prop THEN Map**
- **Power reduction = FIRST Map THEN Prop**

Useful guideline chart that could be used for best propeller/manifold combination is following reported:

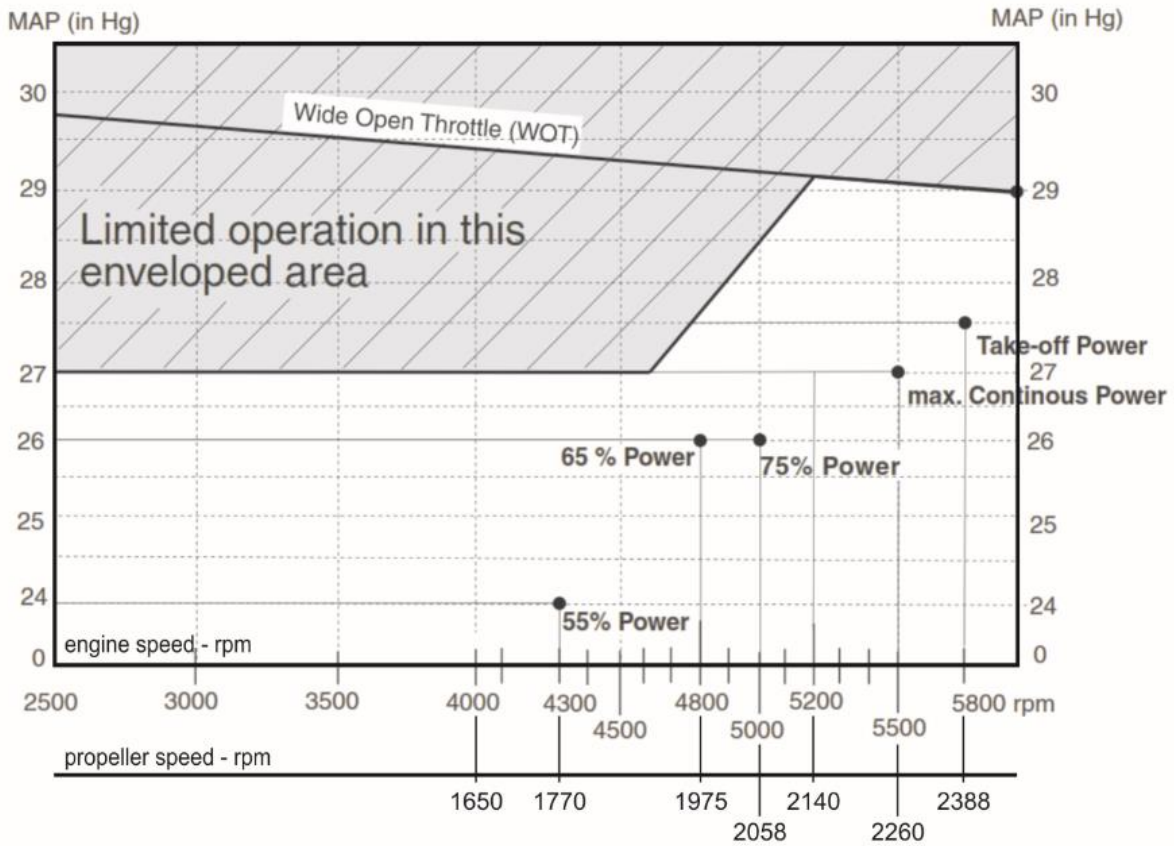

3. Suitable Fuels: Tecnam remember operators to fill the aircraft with approved and suitable fuels. Use of not approved/unknown fuels may cause damages to the engine.

ONLY USE APPROVED FUELS

For details refer to Section 2 of this manual (or applicable Supplement) and latest issue of Rotax SI-912-016

G950 system use

For safety reasons, G950 operational procedures must be learned on the ground.

Document Garmin G950 Pilot's Guide for Tecnam P2006T (P/N 190-01146-XX) – last issue, reports detailed instructions to operate the system in subject. Make always reference to the above mentioned document.



Garmin G950 Pilot's Guide for Tecnam P2006T (P/N 190-01146-XX) – last issue - must be carried onboard the airplane at all times.



To reduce the risk of unsafe operation, carefully review and understand all aspects of the G950 Pilot's Guide documentation at the last issue and the AFM for the aircraft. Thoroughly practice basic operation prior to actual use. During flight operations, carefully compare indications from the G950 to all available navigation sources, including the information from other NAVAIDs, visual sightings, charts, etc. For safety purposes, always resolve any discrepancies before continuing navigation.



Do not use basemap (land and water data) information for primary navigation. Basemap data is intended only to supplement other approved navigation data sources and should be considered as an aid to enhance situational awareness. Do not use outdated database information. Databases used in the G950 system must be updated regularly in order to ensure that the information remains current. Pilots using any outdated database do so entirely at their own risk. Reference "Garmin G950 Pilot's Guide for the Tecnam P2006T" (P/N 190-01146-XX), last issue, Appendix B concerning SD card use and databases.



For safety reasons, G950 operational procedures must be learned on the ground.



Because of variation in the earth's magnetic field, operating the G950 within the following areas could result in loss of reliable attitude and heading indications.

North of 72° North latitude at all longitudes; South of 70° South latitude at all longitudes; North of 65° North latitude between longitude 75° W and 120° W. (Northern Canada); North of 70° North latitude between longitude 70° W and 128° W. (Northern Canada); North of 70° North latitude between longitude 85° E and 114° E. (Northern Russia); South of 55° South latitude between longitude 120° E and 165° E. (Region south of Australia and New Zealand).



The altitude calculated by G950 GPS receivers is geometric height above Mean Sea Level and could vary significantly from the altitude displayed by pressure altimeters, such as the GDC 74A Air Data Computer, or other altimeters in aircraft. GPS altitude should never be used for vertical navigation. Always use pressure altitude displayed by the G950 PFD or other pressure altimeters in aircraft.

NOTE

If the pilot profile is changed during the flight, the HSI could not indicate the correct LOC or VOR indication until the pilot manually tunes the active frequency. Make sure that the displayed indication on the HSI indicator is consistent with the selected frequency.

NOTE

The data contained in the terrain and obstacle databases comes from government agencies. Garmin accurately processes and cross-validates the data, but cannot guarantee the accuracy and completeness of the data. Reference "Garmin G950 Pilot's Guide for the Tecnam P2006T" (P/N 190-01146-XX), last issue, Appendix B concerning SD card use and databases.

NOTE

Use of polarized eyewear may cause the flight displays to appear dim or blank.

2. AIRSPEEDS

2.1. NORMAL OPERATIONS

The following airspeeds are those which are significant for normal operations, with reference to both MTOW: 1180 kg and 1230 kg (if Supplement G10 - Increased MTOW @1230 KG - is applicable).

	FLAPS	MTOW	
		1180kg	1230 kg
Rotation Speed (in takeoff, V_R)	T/O	64 KIAS	65 KIAS
Best Angle-of-Climb Speed (V_X)	0°	73 KIAS	72 KIAS
Best Rate-of-Climb speed (V_Y)	0°	80 KIAS	84 KIAS
Approach speed	T/O	90 KIAS	90 KIAS
Final Approach Speed	FULL	70 KIAS	71 KIAS
Manoeuvring speed (V_A)	0°	118 KIAS	122 KIAS
Never Exceed Speed (V_{NE})	0°	167 KIAS	171 KIAS

2.2. SINGLE ENGINE TRAINING

V_{SSE} is a speed selected as training aid for pilots in the handling of multi-engine aircraft. It is the minimum speed for intentionally rendering on engine inoperative in flight. This minimum speed provides the margin the manufacturer recommends for us when intentionally performing engine inoperative maneuvers during training. Shutting down an engine for training shall not become a habit; for safety purpose, and in order to optimise training, engine shutdown to perform OEI shall be executed only when necessary and required by regulations (e.g. during flight check, skill tests or demonstration as per 14CFR Part61 or similar).

A simulated feather condition is obtained with propeller lever full forward and throttle lever set at 13.5 in Hg MAP at 70-90 KIAS and 2000-4000 ft (density altitude).

Recommended safe simulated OEI speed (V_{SSE})	70 KIAS
--	----------------

NOTE

Keep speed above V_{SSE} for simulated OEI training operations.

In normal operations, shutting down an engine for training shall not become a habit, in particular for safety reasons and in order to optimise training; engine shutdown to perform OEI shall be executed only when required by regulations (e.g. during flight check, skill tests or demonstration as per 14CFR Part61 or equivalent rule).

The continuous operation of engine securing for training may indeed cause long term damages to the engine itself due to the high load coming from propeller (which is in feathering angle during the engine re-starting).

3. NORMAL PROCEDURES CHECKLIST

3.1 RECOMMENDATIONS FOR COLD WEATHER OPERATIONS

Engine cold weather operation

Refer to Rotax 912 Series Operators Manual, last issue, providing instructions for operating media (lubricant and coolant specifications) to be used in cold weather operation.

Parking

When the airplane is parked in cold weather conditions and it is expected to be soaked at temperatures below freezing, some precautions need to be taken.

Clear snow, slush, and ice in the parking area, or at least clear the area around the tires to prevent them from freezing to the ground. Apply plugs on Pitot and static ports.

The exposed airframe parts should be protected, especially the engines, the wheels, the blades and the gears against the snow or ice accumulation. Water and other freezable liquids should be removed from the airplane.

Standing water that could freeze should be removed from critical parts, as flaps and ailerons hinges, trim tabs hinges, drain points, LG doors, cabin doors etc.

With an ambient temperature of below -20°C , remove battery and store in a warm dry place; additionally in order to prevent a heavy discharge and to increase the battery life time, it is recommended to use an external power source for engine starting at temperatures lower than -15°C .

When wheel brakes come in contact with ice, slush, or snow with freezing conditions, the brake disk may freeze: park the aircraft with parking brake control knob in OFF position and ensure the aircraft is properly chocked and moored.

In any case, when the probability of ice, snow, or heavy frost is forecast, the use of a hangar is strongly recommended.

An external inspection of the aircraft is performed before each flight, as prescribed on Section 3.1.

For cold weather operations, the crew must focus on the check of following parts of airplane (free of snow/ice/standing water).

- control surfaces
- fuselage
- wings
- vertical and horizontal stabilator
- stall warning switch
- engine inlets
- engines draining points
- propeller blades
- LG doors
- Pitot, and static ports
- fuel tank vents

Tires show low pressure in cold weather: the required adjustments to inflation pressure should be performed on tires cooled to ambient temperature.

If the crew detects ice, anti icing products are not allowed. To remove ice, tow the aircraft in the hangar and operate with a soft brush or a humid cloth.



Removal of snow/ice accumulations is necessary prior to take-off because they will seriously affect airplane performance. Aircraft with ice/snow accumulation is not cleared for flight.

If the aircraft must be operated in cold weather conditions within the range -25°C to -5°C, it is suggested to perform following procedure in order to speed up the engine warm-up:

- Tow the airplane in a warm hangar (warmer than -5°C);
- Let airplane temperature stabilize;
- Check pressure in hydraulic system, recharge if necessary;
- Heat the cabin to a suitable value to avoid windshield frost in flight; an electrical fan heater may be used inside the cabin;
- Tow airplane outside and perform engine starting as soon as possible.

3.2 PRE-FLIGHT CHECK – AIRCRAFT WALK-AROUND

To perform the aircraft walk-around, carry out the checklists according to the pattern shown in Figure 4-1.



If ignition switches are turned ON, a propeller movement can cause the engine starting with consequent hazard for people nearby.



Visual inspection is defined as follows: check for defects, cracks, delamination, excessive play, unsafe or improper installation as well as for general condition, presence of foreign objects, slippage markers etc. For control surfaces, visual inspection also involves additional check for freedom of movement. Always check the ground in the area of the aircraft for evidence of fuel, oil or operating fluids leakages.

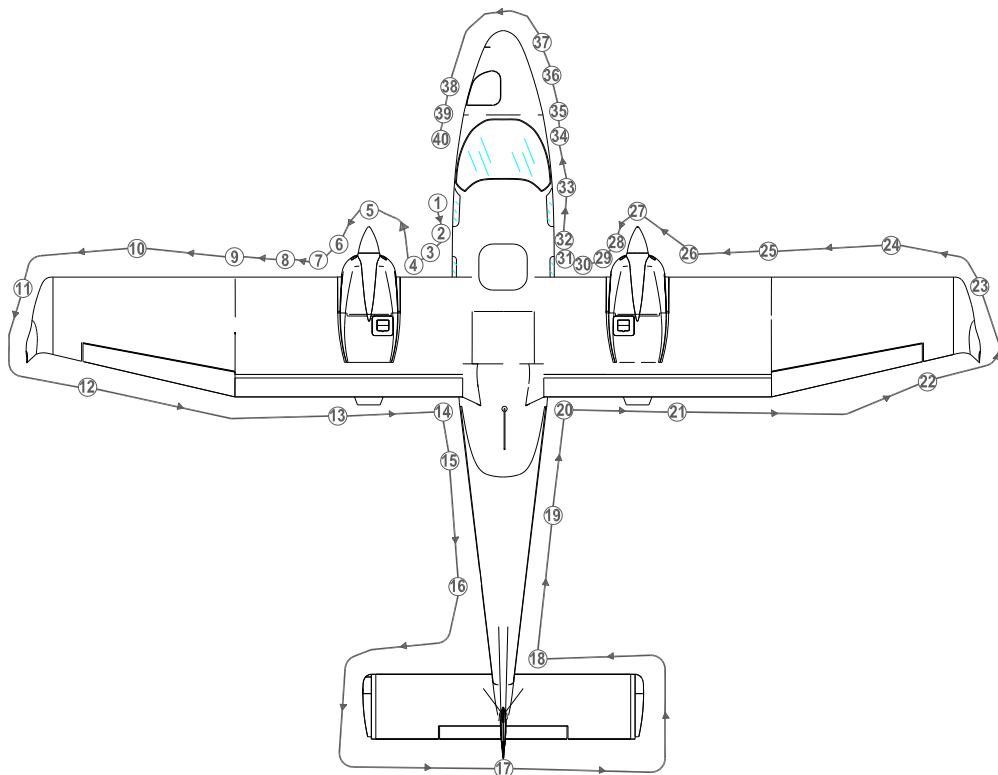

Figure 4.1

-
- | | | |
|---|------------------------|--|
| 1 | Pilot door and cabin | <i>Check door for integrity. Turn ON the Master Switch and check Stall Warning switch for operation and condition; check lighting of Landing/Taxi/Nav/Strobe lights, then turn OFF the Master Switch.</i> |
| 2 | Left main landing gear | <i>Check fuselage skin status, tire status (cuts, bruises, cracks and excessive wear), slip-page markers integrity, gear structure and shock absorber, hoses, gear door attachments and gear micro-switches. There should be no sign of hydraulic fluid leakage.</i> |
| 3 | Wheel chock | <i>Remove if employed</i> |
| 4 | Propeller and spinner | <i>The propeller blades and spinner should be free of cracks, nicks, dents and other defects and should rotate freely. Check fixing and lack of play between blades and hub.</i> |
| 5 | Left engine nacelle | <p><i>Perform following inspections:</i></p> <ul style="list-style-type: none"> <i>a) Check the surface conditions.</i> <i>b) Nacelle inlets and exhausts openings must be free of obstructions. If inlet and outlet plugs are installed, they should be removed.</i> <i>c) Check radiators. There should be no indication of leakage of fluid and they have to be free of obstructions.</i> <i>d) <u>Only before the first flight of a day:</u></i> <ul style="list-style-type: none"> <i>(1) Verify coolant level in the expansion tank, replenish as required up to top (level must be at least 2/3 of the expansion tank).</i> <i>(2) Verify coolant level in the overflow bottle through the slot under the nacelle: level must be between min. and max. mark. Replenish if required removing the upper cowling; after that, install upper cowling checking for interferences with radiators</i> <i>(3) Turn the propeller by hand to and fro, feeling the free rotation of 15° or 30° before the crankshaft starts to rotate. If the propeller can be turned between the</i> |
-

dogs with practically no friction at all further investigation is necessary. Turn propeller by hand in direction of engine rotation several times and observe engine for odd noises or excessive resistance and normal compression.

- e) *Check oil level and replenish as required. Prior to oil check, switch off both ignitions circuits and turn the propeller by hand in direction of engine rotation several times to pump oil from the engine into the oil tank, or let the engine idle for 1 minute. This process is finished when air is returning back to the oil tank and can be noticed by a murmur from the open oil tank. Prior to long flights oil should be added so that the oil level reaches the "max" mark.*
- f) *Drain off Gascolator for water and sediment (drain until no water comes off). Then make sure drain valve is closed.*
- g) *Check drainage hoses clamps*
- h) *Verify all parts are fixed or locked.*
- i) *Verify all inspection doors are closed.*

6 Air induction system

Check engine air inlet for integrity and correct fixing. The air intake filter must be free of obstructions.

7 Left fuel tank

Check that the refuelling port cap is properly secured, then perform the fuel tank sump drainage operating the related valve which, after operation, must be checked closed. Fuel must be checked for water and sediment. Verify the tank vent outlet is clear.

8 Landing and taxi lights

Visual inspection

9 Left wing leading edge

Visual inspection. Check cabin ventilation inlet and carburettor heating inlet for condition and free of obstruction. Check stall strip.

10	Left wing top and bottom panels	<i>Visual inspection</i>
11	Left winglet, nav and strobe lights, static discharge wick	<i>Check for integrity and fixing</i>
12	Left aileron and balance mass	<i>Visual inspection, remove tie-down devices and control locks if employed.</i>
13	Left Flap and hinges	<i>Visual inspection</i>
14	Left static port	<i>Remove protective cap – Visual inspection</i>
15	Antennas	<i>Check for integrity</i>
16	Gear pump, external power and battery compartment	<i>Check emergency landing gear extension system pressure (low pressure limit: 20 bar), external power and battery compartments closure.</i>
17	Horizontal and vertical empennage and tabs. Static discharge wicks.	<i>Check the actuating mechanism of control surfaces and the connection with related tabs. Check wicks for integrity. Remove tie-down device if employed.</i>
18	Stabilator leading edge	<i>Check for integrity</i>
19	Fuselage top and bottom skin	<i>Visual inspection</i>
20	Right static port	<i>Remove protective cap – Visual inspection</i>
21	Right Flap and hinges	<i>Visual inspection</i>
22	Right aileron and balance weight	<i>Visual inspection, remove tie-down devices and control locks if employed.</i>
23	Right winglet, nav and strobe lights, static discharge wick	<i>Check for integrity and fixing and lighting</i>
24	Right wing top and bottom panels	<i>Visual inspection</i>
25	Right wing leading edge	<i>Visual inspection. Check cabin ventilation inlet and carburettor heating inlet for condition and free of obstruction. Check stall strip.</i>
26	Right fuel tank	<i>Check that the refuelling port cap is properly secured, then perform the fuel tank sump drainage operating the related valve which, after operation, must be checked closed. Fuel must be checked for water and sediment. Verify the tank vent outlet is clear.</i>
27	Propeller and spinner:	<i>The propeller blades and spinner should be free of cracks, nicks, dents and other</i>

- defects and should rotate freely. Check fixing and lack of play between blades and hub.*
- | | | |
|-----------|---------------------------|--|
| 28 | Right engine nacelle | <i>Apply check procedure reported in the walk-around station 5 and 6</i> |
| 29 | Passenger door and cabin | <i>Check door for integrity. Check safety belts for integrity and baggage for correct positioning and fastening. Check ditching emergency exit safety lock. Check passengers ventilation ports for proper setting.</i> |
| 30 | Right main landing gear | <i>Apply check procedure reported in the walk-around Station 2</i> |
| 31 | Wheel chock | <i>Remove if employed</i> |
| 32 | Bottom fuselage antennas | <i>Check for integrity</i> |
| 33 | Right cabin ram-air inlet | <i>Visual inspection</i> |
| 34 | Right Pitot tube | <i>Remove protective cap and check for any obstruction</i> |
| 35 | Nose landing gear | <i>Check tire status (cuts, bruises, cracks and excessive wear), slippage markers integrity, gear structure and retraction mechanism, shock absorber and gear doors attachments. There should be no sign of hydraulic fluid leakage.</i> |
| 36 | Radome | <i>Check for integrity</i> |
| 37 | Radome access door | <i>Visual inspection</i> |
| 38 | Left Pitot tube | <i>Remove protective cap and check for any obstruction</i> |
| 39 | Left cabin ram-air inlet | <i>Visual inspection</i> |

NOTE

Avoid blowing inside Pitot-tube and inside airspeed indicator system's static ports as this may damage instruments.

INTENTIONALLY LEFT BLANK

3.3 COCKPIT INSPECTIONS



CAUTION

Instruct passengers on how to use safety belts and normal / emergency exits. Passenger embarkation should be done, avoiding contact with hot / oily parts such as engine exhaust pipes, drainage tubes and wheel brakes, or sharp wing control surfaces edges. Do not smoke on board.



CAUTION

Clean the displays using a clean, lint-free cloth and an eyeglass lens cleaner that is specified as safe for anti-reflective coatings. Cleaners containing ammonia will harm the anti-reflective coating.

1. Parking brake	<i>CHECK ENGAGED</i>
2. AFM and Garmin Pilot's Guide	<i>CHECK on board</i>
3. Weight and balance	<i>CHECK if within the limits</i>
4. Flight controls	<i>Remove seat belt used as lock</i>
5. PFD and MFD	<i>CHECK clean</i>
6. Seat	<i>Adjust as required</i>
7. Seat belt	<i>Fastened</i>
8. Passenger briefing	<i>Completed</i>
9. Doors	<i>CLOSED AND LOCKED</i>
10. Landing gear control lever	<i>CHECK DOWN</i>
11. Breakers	<i>All IN</i>
12. MASTER SWITCH	<i>ON</i>
13. Fuel quantity	<i>CHECK</i>
14. RH fuel selector	<i>RIGHT</i>
15. LH fuel selector	<i>LEFT</i>
16. RH Electrical Fuel Pump	<i>ON, check fuel pressure gauge correct operation.</i>
17. RH Electrical Fuel pump	<i>OFF, check pressure decreased at zero</i>
18. LH Electrical Fuel Pump	<i>ON, check fuel pressure gauge correct operation.</i>
19. LH Electrical Fuel pump	<i>OFF, check pressure decreased at zero</i>
20. Strobe light	<i>ON</i>
21. Landing gear lights	<i>TEST</i>
22. ELT	<i>CHECK set to ARM</i>
23. Fire detector	<i>TEST</i>
24. Engine levers friction	<i>Adjust if required</i>
25. Flight controls	<i>CHECK free</i>
26. Alternate static port	<i>CHECK closed</i>

- | | | |
|-----|---|---|
| 27. | Cabin heat | <i>CLOSED</i> |
| 28. | Flaps | <i>Operate control to FULL position.
Verify extension. Retract flaps.</i> |
| 29. | Pitch trim control | <i>Set to neutral position.</i> |
| 30. | Rudder trim control | <i>Set to neutral position.</i> |
| 31. | Eng. Starting Battery Voltmeter
(if installed) | <i>Check 12 to 14 Volt</i> |

INTENTIONALLY LEFT BLANK

3.4 ENGINE STARTING



CAUTION

Avionics switches must be set OFF during engine starting to prevent avion-ic equipment damage.

- | | | |
|---|-----------------|-------------------------|
| 1 | Start clearance | <i>Obtain if needed</i> |
|---|-----------------|-------------------------|

Right engine starting

- | | | |
|---|--------------------|-----------------------|
| 2 | RH Throttle lever | <i>IDLE</i> |
| 3 | RH Carburetor heat | <i>OFF</i> |
| 4 | RH Propeller Lever | <i>FULL FORWARD</i> |
| 5 | RH Choke | <i>ON if required</i> |

NOTE

Cold engine.

Throttles idle (fully closed), chokes fully opened.

Soon after starting advance the throttle to ~800 RPM and slowly close the choke. Keep engine at ~900 RPM for warm up period.

Hot engine.

Park the aircraft with the nose pointing into wind in order to aid cooling. Keep chokes closed and slowly open the throttles one inch while cranking.

“Flooded Engine” (after engine start failure).

Keep chokes closed, open throttle fully and start the engine, then quickly re-duce throttles to idle

- | | | |
|---|--------------------------|--|
| 6 | RH Electrical Fuel pump | <i>ON, check advisory light ON and posi-tive fuel press build up</i> |
| 7 | RH engine propeller zone | <i>CHECK free</i> |
| 8 | RH ignitions switches | <i>BOTH ON</i> |



WARNING

Ensure that the area around engine propeller disc is clear from people and obstacles. Call out for propeller free.

- | | | |
|----|---------------------|---|
| 9 | RH start pushbutton | <i>PUSH</i> |
| 10 | RH Field | <i>ON</i> |
| 11 | RH engine oil gauge | <i>CHECK if increasing within 10 sec. (max 7 bar in cold operation)</i> |
| 12 | RH propeller RPM | <i>1200 RPM</i> |

13	RH Choke	<i>OFF</i>
14	RH Avionics	<i>ON</i>
15	RH Cross bus	<i>ON</i>
16	RH Ammeter	<i>CHECK Amps positive</i>
17	Voltmeter	<i>CHECK 12 to 14 Volt</i>
18	Chronometer	<i>Start</i>
19	Strobe light	<i>ON</i>

Left engine starting

1	LH Throttle lever	<i>IDLE</i>
2	LH Carburetor heat	<i>OFF</i>
3	LH Propeller Lever	<i>FULL FORWARD</i>
4	LH Choke	<i>ON if required</i>
5	LH Electrical Fuel pump	<i>ON, check advisory light ON and positive fuel press build up</i>
6	LH engine propeller zone	<i>CHECK free</i>
7	LH ignitions switches	<i>BOTH ON</i>



WARNING

Ensure that the area around engine propeller disc is clear from people and obstacles. Call out for propeller free.

8	LH start pushbutton	<i>PUSH</i>
9	LH Field	<i>ON</i>
10	LH engine oil gauge	<i>CHECK if increasing within 10 sec. (max 7 bar in cold operation)</i>
11	LH propeller RPM	<i>1200 RPM</i>
12	LH Choke	<i>OFF</i>
13	LH Avionics	<i>ON</i>
14	LH Cross bus	<i>ON</i>
15	LH Ammeter	<i>CHECK Amps positive</i>

3.5 BEFORE TAXIING

- 1 Let the engines warm up to a minimum oil temperature of 50°C at 1200 RPM
- 2 Nav , Taxi and Landing lights *ON*
- 3 Transponder *Stand-by*
- 4 Passengers and crews seat belts *Fastened*
- 5 Passengers and crews headphones *Set as required*

3.6 TAXIING

NOTE

Ensure that the main and passengers' doors warning lights are turned off.

- 1 LH/RH Fuel Selector *As required*
- 2 LH and RH fuel pressure *Monitor*
- 3 Parking Brake *RELEASE*
- 4 Flight instruments *CHECK*
- 5 Engine instruments *CHECK*
- 6 Altimeter *SET both and crosscheck
max difference 150 ft*
- 7 Brakes *TEST*

3.7 PRIOR TO TAKEOFF

- | | | |
|-----------|-------------------------------------|---|
| 1 | Parking Brake | <i>ENGAGED</i> |
| 2 | RH Fuel Selector | <i>RIGHT</i> |
| 3 | LH Fuel Selector | <i>LEFT</i> |
| 4 | LH and RH fuel pressure | <i>CHECK</i> |
| 5 | LH and RH Engine parameters checks: | |
| | • Oil temperature: | <i>50-110 °</i> |
| | • CHT: | <i>Max 135°</i> |
| | • Oil pressure: | <i>2-5 bar (above 1400 RPM); 0.8 bar (below 1400 RPM)</i> |
| | • Fuel pressure: | <i>2.2 – 5.8 psi (0.15 - 0.40 bar)</i>
<i>*2.2 – 7.26 psi (0.15 – 0.50 bar)</i> |
| | | <i>*applicable for fuel pump part no.893110 and no.893114</i> |
| 6 | LH and RH Generator lights | <i>CHECK BOTH OFF</i> |
| 7 | LH and RH Propeller Lever | <i>FULL FORWARD</i> |
| 8 | LH and RH Throttle Lever | <i>1650 RPM</i> |
| | RH Ignitions switches | <i>Set L / R / BOTH (RPM drop with single ignition circuit selected must not exceed 130 prop's RPM; maximum RPM difference by use of either circuits LEFT or RIGHT cannot overcome 50 RPM)</i> |
| 9 | RH Propeller Lever | <i>Governor check. Retard the prop lever until 1100 RPM. The purging cycle should be repeated up to 4 times, with the governor closely (firmly and positively) control the rpm. Verify 1650 prop RPM are restored with prop lever at full forward position.</i> |
| 10 | RH Carburettor heat | <i>ON, verify propeller RPM decreasing about 100 RPM</i> |
| 11 | RH Carburettor heat | <i>OFF</i> |
| 12 | RH engine instruments | <i>CHECK parameters if within green arcs</i> |
| 13 | LH Ignitions switches | <i>Set L / R / BOTH (RPM drop with single ignition circuit selected must not exceed 130 prop's RPM; maximum RPM difference by use of either circuits LEFT or RIGHT cannot overcome 50 RPM)</i> |

14	LH Propeller Lever	<i>Governor check. Retard the prop lever until 1100 RPM. The purging cycle should be repeated up to 4 times, with the governor closely (firmly and positively) control the rpm. Verify 1650 prop RPM are restored with prop lever at full forward position.</i>
15	LH Carburettor heat	<i>ON, verify propeller RPM decreasing about 100 RPM</i>
16	LH Carburettor heat	<i>OFF</i>
17	LH engine instruments	<i>CHECK parameters if within green arcs</i>
18	LH and RH Fuel quantity indicator	<i>CHECK consistent with fuel plan</i>
19	Flaps	<i>T/O or as required (see Section 5, Take OFF performances)</i>
20	Pitch trim and rudder trim	<i>SET neutral position</i>
21	Flight controls	<i>Check free</i>
22	Seat belts fastened and doors closed and locked	<i>CHECK</i>

3.8 LINE-UP

1	Parking Brake	<i>RELEASE, check full in</i>
2	Annunciator window	<i>CHECK cautions and warnings OFF</i>
3	RH Fuel Selector	<i>RIGHT</i>
4	LH Fuel Selector	<i>LEFT</i>
5	Pitot heat	<i>as required</i>
6	XPDR	<i>SET ALT</i>
7	Magnetic compass	<i>CHECK</i>
8	AHRS	<i>CROSS CHECK</i>

3.9 TAKEOFF AND CLIMB

- | | | |
|---|--------------------------------|------------------------------|
| 1 | Landing light | ON |
| 2 | LH and RH Electrical Fuel pump | BOTH ON |
| 3 | Carburetors heat | CHECK OFF |
| 4 | LH and RH Propeller Lever | FULL FORWARD |
| 5 | LH and RH Throttle Lever | FULL POWER |
| 6 | Engines instruments | Parameters within green arcs |
| 7 | Rotation speed | |

MTOW 1180kg	MTOW 1230 kg
Vr = 64 KIAS	Vr = 65 KIAS

- | | | |
|----|-------------------------------------|--|
| 8 | Apply brakes to stop wheel spinning | |
| 9 | Landing gear control knob | UP: check green lights and TRANS light turned OFF within about 20"
OFF above 10000 ft |
| 10 | Landing and taxi lights | OFF above 10000 ft |
| 11 | LH and RH Propeller Lever | Set max cont power at safe altitude |



CAUTION

Max take off power must be limited to 5 minutes. Reduce Throttles MAP power before retracting Propeller to 2200 RPM or below.

- | | | |
|----|--------------------------------|----------|
| 12 | LH and RH Electrical Fuel pump | BOTH OFF |
|----|--------------------------------|----------|

NOTE

It is recommended to retract landing gear when a positive climb rate is ensured at the applicable best speed (V_Y or V_X as necessary).

It has been demonstrated that best climb rate is always obtained with flaps in UP position: refer to Section 5, "Take off rate of climb" and "Enroute rate of climb" tables.

Noteworthy best climb gradient speed (V_X) flaps UP is lower than best climb speed (V_X) flaps T/O up to 6000 ft (density altitude). Refer to Section 5, "Best climb gradient speed" table.

3.10 CRUISE

- 1 LH and RH Propeller Lever *SET to 1900-2250 RPM*



CAUTION

Throttles MAP decrease should be made before propeller speed reduction below 2200 RPM, as, contrariwise, Propeller Lever increase RPM should be set before engine Throttle Levers are advanced.

- 2 Engine parameters check (LH and RH)

- Oil temperature: $90^{\circ} \div 110^{\circ} \text{ C}$.
- CHT: $90^{\circ} \div 110^{\circ} \text{ C}$
- Oil pressure: $2 - 5 \text{ bar}$.
- Fuel pressure: $2.2 - 5.8 \text{ psi}$
 $*2.2 - 7.26 \text{ psi} (0.15 - 0.50 \text{ bar})$

**applicable for fuel pump part no.893110 and no.893114*

- 3 Carburettor heat as needed (*see also instructions addressed on Section 3, Para. 7.4*)



WARNING

Deselect and do not use Auto Pilot if possible icing condition area is inadvertently entered.

- 4 Fuel balance and crossfeed *check as necessary*

3.11 TURBULENT AIR OPERATION

In keeping with good operating practice used in all aircraft, it is recommended that when turbulent air is encountered or expected, the airspeed be reduced to maneuvering speed to reduce the structural loads caused by gusts and to allow for inadvertent speed build-ups, which may occur as a result of the turbulence or of distractions caused by the conditions.

3.12 DESCENT AND APPROACH

- | | | |
|---|-------------------|---------------------------------------|
| 1 | Propellers | <i>Set to Max Continuous 2250 RPM</i> |
| 2 | Carburettors heat | <i>As required</i> |
| 3 | Altimeter setting | <i>QNH set and crosscheck</i> |

3.13 BEFORE LANDING

- | | | |
|---|--------------------------------|---|
| 1 | Rear passengers seats | <i>Seats set at full aft and lower position</i> |
| 2 | LH and RH Electrical Fuel pump | <i>BOTH ON</i> |
| 3 | On downwind leg: | |

MTOW 1180kg	MTOW 1230 kg
<i>V_{FE}= 119KIAS</i>	<i>V_{FE}=122KIAS</i>

Flaps T/O

- | | | |
|---|-----------------------------------|---|
| 4 | Speed below applicable VLO/VLE | <i>Landing gear control knob - DOWN –
Check green lights ON</i> |
| 5 | Carburettors heat | <i>CHECK OFF</i> |
| 6 | LH and RH Propeller Lever | <i>FULL FORWARD</i> |
| 7 | On final leg: speed below 93 KIAS | <i>Flaps FULL</i> |
| 8 | Final Approach Speed | |

MTOW 1180kg	MTOW 1230 kg
<i>V_{APP}= 70KIAS</i>	<i>V_{APP}=71KIAS</i>

- | | | |
|----|------------------------|----------------|
| 9 | Landing and taxi light | <i>ON</i> |
| 10 | Touchdown speed | <i>65 KIAS</i> |

3.14 BALKED LANDING/MISSED APPROACH

- | | | |
|---|---------------------------|---------------------|
| 1 | LH and RH Propeller Lever | <i>FULL FORWARD</i> |
| 2 | LH and RH Throttle Lever | <i>FULL POWER</i> |

**CAUTION**

Propeller Lever increase to max RPM should be attained before engine Throttle Levers are advanced to max take off power. Max take off power must be limited to 5 minutes.

- | | | |
|---|--------------|---|
| 3 | Flaps | <i>T/O</i> |
| 4 | Speed | <i>Keep over 62 KIAS, climb to V_Y or V_X as applicable</i> |
| 5 | Landing gear | <i>UP as positive climb is achieved</i> |
| 6 | Flaps | <i>UP</i> |

NOTE

It is recommended to retract landing gear when a positive climb rate is ensured at the applicable best speed (V_Y or V_X as necessary).

It has been demonstrated that best climb rate is always obtained with flaps in UP position: refer to Section 5, "Take off rate of climb" and "Enroute rate of climb" tables.

Noteworthy best climb gradient speed (V_X) flaps UP is lower than best climb speed (V_X) flaps T/O up to 6000 ft (density altitude). Refer to Section 5, "Best climb gradient speed" table.

3.15 AFTER LANDING

- | | | |
|---|--------------------------------|-----------------|
| 1 | LH and RH Electrical Fuel pump | <i>BOTH OFF</i> |
| 2 | Flaps | <i>0°</i> |
| 3 | Landing light | <i>OFF</i> |

3.16 PARKING/SHUT DOWN

NOTE

It is always suggested to park the aircraft with the nose pointing into wind to improve cooling after shut down.

- | | | |
|---|-----------------------|--|
| 1 | Parking brake | <i>Engage</i> |
| 2 | Taxi light | <i>OFF</i> |
| 3 | Engines | <i>Allow for cooling down 1 minute at idle power</i> |
| 4 | LH and RH AVIONIC BUS | <i>OFF</i> |
| 5 | LH and RH CROSS BUS | <i>OFF</i> |
| 6 | Flaps | <i>Check in UP</i> |
| 7 | Trims | <i>Check neutrals</i> |
| 8 | Navigation lights | <i>OFF</i> |

NOTE

Ensure the engine is at its lowest possible idle speed before selecting ignitions off.

- | | | |
|----|------------------------------|-----------------------------|
| 9 | Ignitions | <i>Turn OFF one at time</i> |
| 10 | Doors safety locks | <i>Check OFF</i> |
| 11 | LH/RH Field | <i>OFF</i> |
| 12 | All external lights | <i>OFF</i> |
| 13 | Master Switch | <i>OFF</i> |
| 14 | LH and RH Fuel Selector | <i>BOTH OFF</i> |
| 15 | Emg Batt / Emg cockpit light | <i>Check OFF</i> |



WARNING

Before disembarkation verify propellers are fully stopped.



CAUTION

Instruct passengers to fully open pax door (against nacelle stop) and depart alongside aircraft fuselage, avoiding contact with hot / oily parts such as engine exhaust pipes, drainage tubes and wheel brakes, or sharp wing control surfaces edges.



CAUTION

Crew should avoid propeller disc area crossing while proceeding alongside a fully opened pilot's door (up to 110°).

3.17 POSTFLIGHT CHECKS

- 1 Protective cover for Pitot tubes, stall warning and static port plugs. *Install*
- 2 Lock one control wheel with safety belt.
- 3 Wheel chocks *Place under MLG*
- 4 Aileron lock *Place and tighten*
- 5 Pilot and passengers doors. *Close and latch*

4. GROUND TOWING, PARKING AND MOORING

4.1. TOWING



CAUTION

When the a/c is moved on the ground, the Master Switch must be turned ON until the a/c is parked.

To tow the aircraft it is necessary to use a metal stiff bar connected to the nose gear.



WARNING

Do not turn nose wheel above 20° either side of center: greater steering angles can damage the wheel stop. The tow bar must be removed before engines starting.

4.2. PARKING

General

Under normal weather conditions, the airplane may be parked and headed in a direction that will facilitate servicing without regard to prevailing winds. Ensure that it is sufficiently protected against adverse weather conditions and present no danger to other aircraft.

Procedure

1. Position airplane on levelled surface, headed into the prevailing wind, if practical.
2. Engage parking brake and install control locks
3. Secure pilot control wheel by wrapping the seat belt around it.

NOTE:

Do not engage the parking brakes at low ambient temperature; accumulation of moisture may cause the brakes to freeze. In this case use wheel chocks.

In case of long time parking or overnight parking, it is recommended to moor the a/c as shown on Para. 4.3.



CAUTION

Moorings is strongly recommended when the wind is more than 15 knots and the a/c is completely refuelled.

4.3. MOORING

The aircraft is moored to insure its immovability, protection, and security under various weather conditions.



CAUTION

Mooring is strongly recommended when the wind is more than 15 knots and the a/c is completely refuelled.

Procedure

1. Position airplane on levelled surface and headed into the prevailing wind.
2. Center nose wheel, engage parking brake and/or use the wheel chocks.

NOTE:

Do not engage the parking brakes at low ambient temperature; accumulation of moisture may cause the brakes to freeze. In this case use wheel chocks.

3. Secure pilot control wheel by wrapping the seat belt around it
4. Assure flaps are retracted
5. Electrically ground airplane, by connecting ground cable to the engine muffle
6. Install control locks and protective plugs.
7. Close and lock cabin doors.
8. Secure tie-down cables to the nose gear leg (in correspondence of the wheel fork) and to the wings and tail cone tie-down rings at approximately 45 degree with respect to the ground. (Refer to following figures)

NOTE:

Additional preparation for high winds includes tie-down ropes from the main landing gear forks employment.

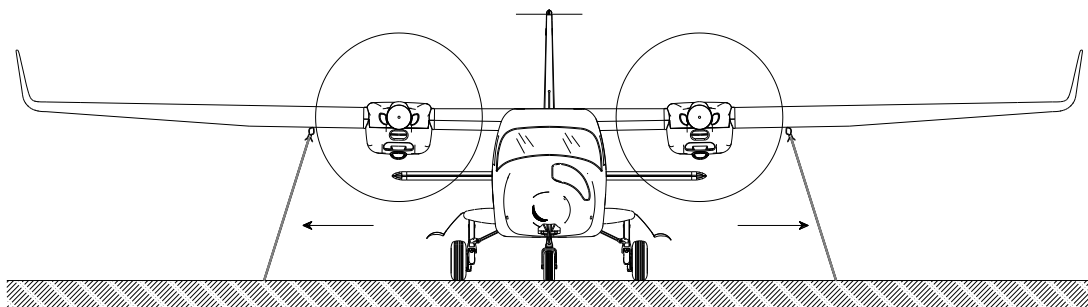

Mooring – front view

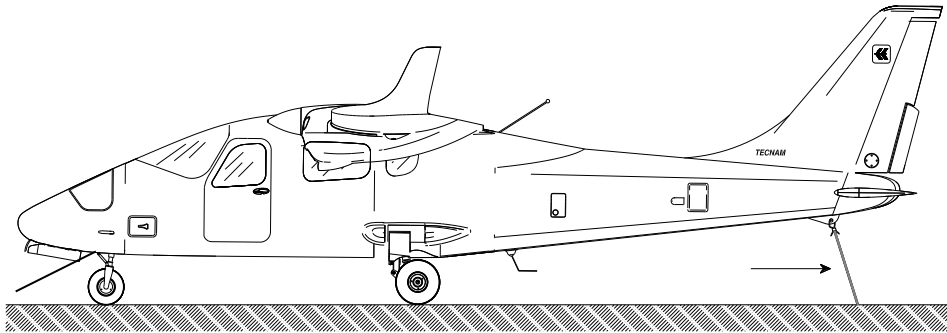

Mooring – side view

INTENTIONALLY LEFT BLANK

SECTION 5 - PERFORMANCES

INDEX

1. Introduction.....	2
2. Use of performances charts.....	2
3. Airspeed indicator system calibration	3
4. ICAO Standard Atmosphere.....	4
5. Stall speed	5
6. Crosswind.....	6
7. Takeoff performances	7
8. Take-off Rate of Climb at V_y.....	10
9. Take-off Rate of Climb at V_x.....	11
10. Enroute Rate of Climb at V_y.....	12
11. Enroute Rate of Climb at V_x	13
12. One-Engine Rate of Climb at V_{ySE}	14
13. One-Engine Rate of Climb at V_{xSE}	15
14. Cruise performances	16
15. Landing performances.....	19
16. Balked landing climb gradient.....	22
17. Noise data	22

1. INTRODUCTION

This section provides all necessary data for an accurate and comprehensive planning of flight activity from takeoff to landing.

Data reported in graphs and/or in tables were determined using:

- “Flight Test Data” under conditions prescribed by EASA CS-23 regulation
- aircraft and engine in good condition
- average piloting techniques

Each graph or table was determined according to ICAO Standard Atmosphere (ISA - s.l.); evaluations of the impact on performances were carried out by theoretical means for:

- * airspeed
- * external temperature
- * altitude
- * weight
- * runway type and condition

2. USE OF PERFORMANCES CHARTS

Performances data are presented in tabular or graphical form to illustrate the effect of different variables such as altitude, temperature and weight. Given information is sufficient to plan the mission with required precision and safety.

Additional information is provided for each table or graph.

3. AIRSPEED INDICATOR SYSTEM CALIBRATION

Graph shows calibrated airspeed V_{CAS} as a function of indicated airspeed V_{IAS} .

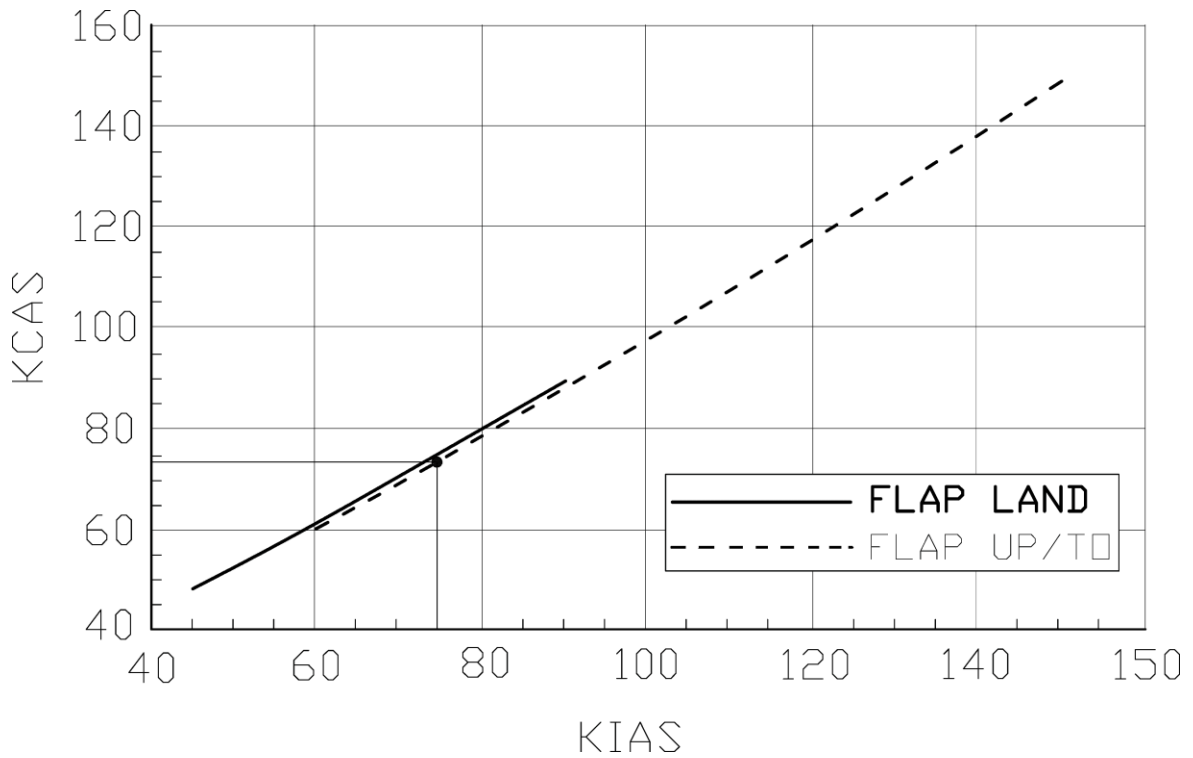

Figure 1 - IAS/CAS chart

Example:

Given

KIAS 75

Find

KCAS 74

4. ICAO STANDARD ATMOSPHERE

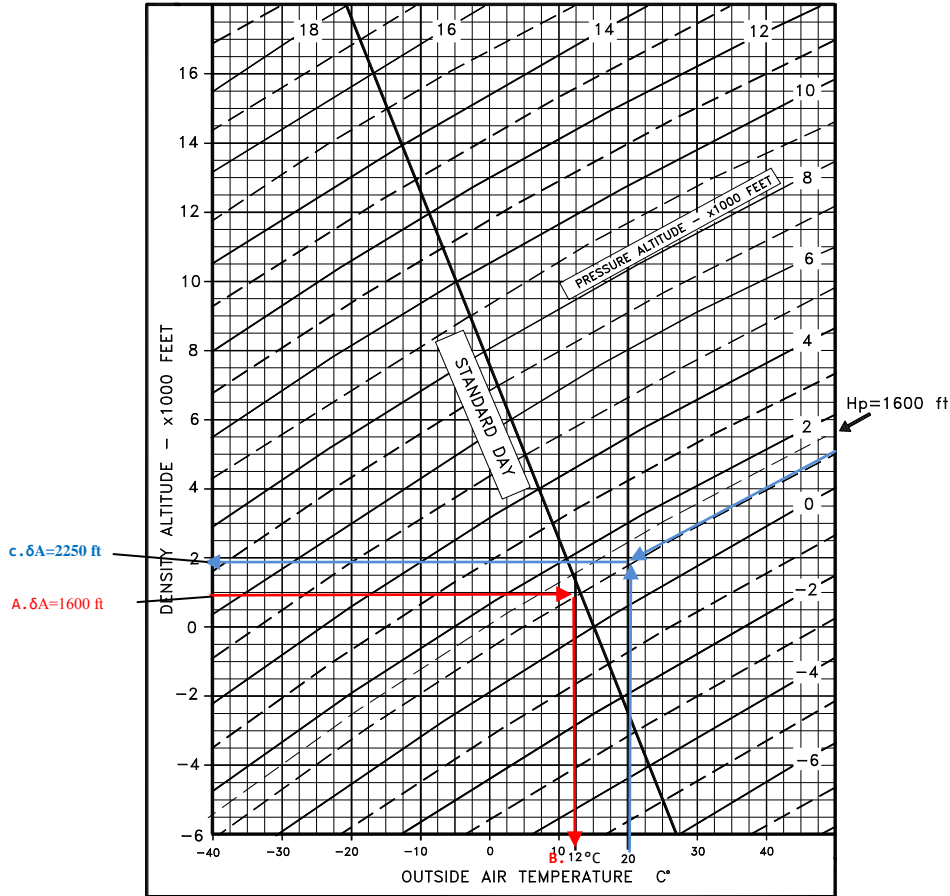

Figure 2 – ICAO chart

Examples:

<p><u>Given</u></p> <p>a. Temperature = 20°C</p> <p>b. Pressure altitude = 1600'</p>	}	→	<p><u>Find</u></p> <p>c. Corresponding Density Altitude = 2250'</p>
---	---	---	--

<p><u>Given</u></p> <p>A. Pressure altitude = 1600'</p> <p>ISA condition</p>	}	→	<p><u>Find</u></p> <p>B. ISA Air Temperature = 12°C</p>
---	---	---	--

5. STALL SPEED

Weight: 1230 kg (2712 lb)

Throttle Levers: IDLE

Landing Gear: Down

CG: Most Forward (16.5%)

No ground effect

WEIGHT [kg]	BANK ANGLE [deg]	STALL SPEED					
		FLAPS 0°		FLAPS T/O		FLAPS FULL	
		KIAS	KCAS	KIAS	KCAS	KIAS	KCAS
1230 (FWD C.G.)	0	66	65	59	57	54	55
	15	67	66	58	58	55	56
	30	71	70	61	61	59	59
	45	79	78	68	68	65	65
	60	95	93	83	81	79	78

NOTE

Altitude loss during conventional stall recovery, as demonstrated during flight tests is approximately 250 ft with banking below 30°.

6. CROSSWIND

Maximum demonstrated crosswind is 17 Kts

⇒ Example:

Given

Wind direction (with respect to aircraft longitudinal axis) = 30°

Wind speed = 20 Kts

Find

Headwind = 17.5 Kts

Crosswind = 10 Kts

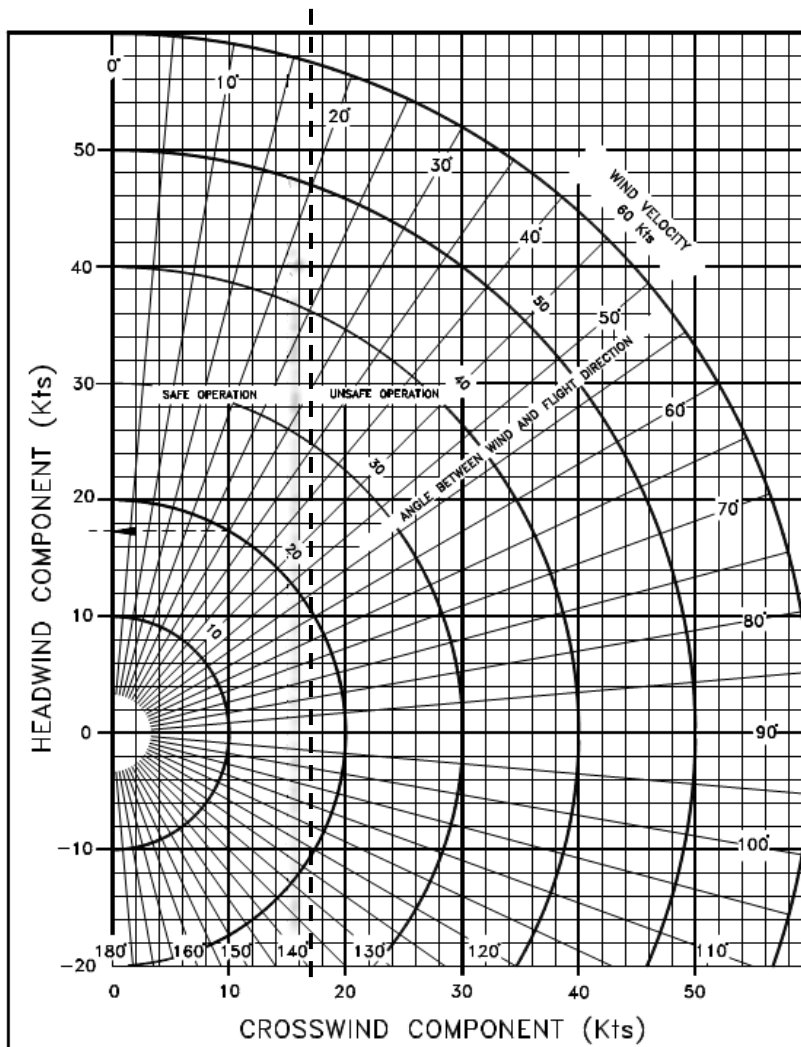

Figure 3 – Crosswind diagram

7. TAKEOFF PERFORMANCES

Pressure Altitude [ft]		Distance [m]					ISA
		Temperature [°C]					
		-25	0	25	50		
S.L.		Ground Roll	207	263	328	401	301
		At 50 ft AGL	271	345	429	525	394
1000		Ground Roll	231	294	366	447	330
		At 50 ft AGL	303	385	479	586	432
2000		Ground Roll	258	328	409	500	362
		At 50 ft AGL	338	430	535	654	474
3000		Ground Roll	289	367	457	559	398
		At 50 ft AGL	378	480	598	731	521
4000		Ground Roll	323	411	511	625	438
		At 50 ft AGL	423	537	669	818	573
5000		Ground Roll	362	460	572	700	481
		At 50 ft AGL	473	602	749	916	630
6000		Ground Roll	405	515	642	785	530
		At 50 ft AGL	531	675	840	1027	694
7000		Ground Roll	455	578	720	880	584
		At 50 ft AGL	595	757	942	1152	765
8000		Ground Roll	511	650	809	989	645
		At 50 ft AGL	669	850	1059	1295	844
9000		Ground Roll	575	730	909	1112	712
		At 50 ft AGL	752	956	1190	1456	932
10000		Ground Roll	647	822	1023	1252	786
		At 50 ft AGL	847	1076	1340	1638	1029

Pressure Altitude [ft]		Distance [m]					ISA
		Temperature [°C]					
		-25	0	25	50		
S.L.	Ground Roll	148	188	234	286	215	
	At 50 ft AGL	193	246	306	374	281	
1000	Ground Roll	165	210	261	319	235	
	At 50 ft AGL	216	274	341	418	308	
2000	Ground Roll	184	234	291	356	258	
	At 50 ft AGL	241	306	381	466	338	
3000	Ground Roll	206	262	326	398	284	
	At 50 ft AGL	269	342	426	521	372	
4000	Ground Roll	230	293	364	446	312	
	At 50 ft AGL	301	383	477	583	409	
5000	Ground Roll	258	328	408	499	343	
	At 50 ft AGL	338	429	534	653	449	
6000	Ground Roll	289	368	457	559	378	
	At 50 ft AGL	378	481	599	732	495	
7000	Ground Roll	324	412	513	628	417	
	At 50 ft AGL	425	540	672	822	545	
8000	Ground Roll	364	463	577	705	460	
	At 50 ft AGL	477	606	755	923	602	
9000	Ground Roll	410	521	648	793	508	
	At 50 ft AGL	536	682	849	1038	664	
10000	Ground Roll	461	586	730	893	561	
	At 50 ft AGL	604	767	955	1168	734	

Weight = 1080 kg (2381 lb)

Corrections

Flaps: T/O

Speed at Lift-Off = 65 KIAS

Speed Over 50ft Obstacle = 70 KIAS

Throttle Levers: Full Forward

Runway: Grass

Headwind: - 2.5m for each kt (8 ft/kt)

Tailwind: + 10m for each kt (33ft/kt)

Paved Runway: - 6% to Ground Roll

Runway slope: + 5% to Ground Roll for each +1%

Section 5 - Performances

TAKEOFF PERFORMANCES

Pressure Altitude [ft]		Distance [m]					ISA
		Temperature [°C]					
		-25	0	25	50		
S.L.	Ground Roll	100	127	158	194	146	
	At 50 ft AGL	131	167	207	254	190	
1000	Ground Roll	112	142	177	216	160	
	At 50 ft AGL	146	186	231	283	209	
2000	Ground Roll	125	159	197	242	175	
	At 50 ft AGL	163	208	258	316	229	
3000	Ground Roll	140	177	221	270	192	
	At 50 ft AGL	183	232	289	353	252	
4000	Ground Roll	156	198	247	302	212	
	At 50 ft AGL	204	260	323	395	277	
5000	Ground Roll	175	222	277	338	233	
	At 50 ft AGL	229	291	362	443	305	
6000	Ground Roll	196	249	310	379	256	
	At 50 ft AGL	257	326	406	496	335	
7000	Ground Roll	220	280	348	426	282	
	At 50 ft AGL	288	366	455	557	370	
8000	Ground Roll	247	314	391	478	312	
	At 50 ft AGL	323	411	512	626	408	
9000	Ground Roll	278	353	440	538	344	
	At 50 ft AGL	364	462	575	704	450	
10000	Ground Roll	313	397	495	605	380	
	At 50 ft AGL	409	520	648	792	498	

Weight = 930 kg (2051 lb)

Flaps: T/O
Speed at Lift-Off = 65 KIAS
Speed Over 50ft Obstacle = 70 KIAS
Throttle Levers: Full Forward
Runway: Grass

Corrections
Headwind: - 2.5m for each kt (8 ft/kt)
Tailwind: + 10m for each kt (33ft/kt)
Paved Runway: - 6% to Ground Roll
Runway slope: + 5% to Ground Roll for each +1%

Section 5 - Performances

TAKEOFF PERFORMANCES

8. TAKE-OFF RATE OF CLIMB AT V_Y

Power Setting: Maximum Continuous Power Flaps: Take-Off Landing Gear: Up							
Weight	Pressure Altitude	Climb Speed V_Y	Rate of Climb [ft/min]				
			Temperature [°C]				ISA
[kg]	[ft]	[KIAS]	-25	0	25	50	
1230	S.L.	86	1276	1088	920	768	985
	2000	83	1133	948	783	634	873
	4000	79	990	809	646	500	761
	6000	76	848	670	510	366	649
	8000	73	707	531	374	233	537
	10000	70	565	393	239	100	425
	12000	67	425	256	104	-32	313
	14000	64	285	118	-30	-164	201
1080	S.L.	85	1507	1302	1119	954	1190
	2000	82	1351	1150	970	808	1068
	4000	79	1196	998	822	662	946
	6000	76	1041	847	674	517	825
	8000	73	887	696	526	372	703
	10000	69	734	546	379	228	581
	12000	66	581	397	232	84	459
	14000	63	428	248	86	-59	338
930	S.L.	85	1803	1575	1372	1189	1451
	2000	82	1630	1406	1206	1026	1315
	4000	79	1457	1238	1041	864	1180
	6000	75	1286	1070	877	703	1045
	8000	72	1114	902	713	542	909
	10000	69	944	735	549	382	774
	12000	65	774	569	387	222	639
	14000	62	604	404	224	63	503

9. TAKE-OFF RATE OF CLIMB AT V_x

Power Setting: Maximum Continuous Power Flaps: Take-Off Landing Gear: Up							
Weight [kg]	Pressure Altitude [ft]	Climb Speed V_x [KIAS]	Rate of Climb at V_x [ft/min]				
			Temperature [°C]				ISA
			-25	0	25	50	
1230	S.L.	78	1214	1037	880	738	941
	1000	76	1147	972	816	675	888
	2000	75	1080	906	751	612	836
	3000	74	1013	841	687	549	783
	4000	73	946	776	623	486	731
	5000	72	879	710	560	424	678
	6000	71	813	645	496	361	626
	7000	70	746	580	432	299	574
1080	S.L.	78	1283	1102	940	794	1002
	1000	76	1214	1034	874	729	949
	2000	75	1145	967	808	664	895
	3000	74	1076	900	742	600	841
	4000	73	1008	833	676	535	787
	5000	72	939	766	611	471	733
	6000	71	871	699	545	407	679
	7000	70	803	632	480	342	625
930	S.L.	78	1435	1243	1072	918	1138
	1000	76	1362	1172	1002	849	1081
	2000	75	1289	1101	932	780	1024
	3000	74	1216	1030	863	712	967
	4000	73	1144	958	793	644	910
	5000	72	1071	888	724	576	853
	6000	71	999	817	654	508	796
	7000	69	927	746	585	440	739

10. ENROUTE RATE OF CLIMB AT V_y

Power Setting: Maximum Continuous Power Flaps: Up Landing Gear: Up							
Weight [kg]	Pressure Altitude [ft]	Climb Speed V_y [KIAS]	Rate of Climb [ft/min]				ISA
			Temperature [°C]				
			-25	0	25	50	
1230	S.L.	84	1317	1135	973	827	1036
	2000	83	1179	1000	841	697	928
	4000	81	1041	865	709	568	819
	6000	80	904	731	577	439	711
	8000	78	767	598	446	310	603
	10000	77	631	464	316	182	495
	12000	75	495	332	186	54	387
	14000	73	360	199	56	-73	279
1080	S.L.	83	1560	1360	1182	1022	1251
	2000	82	1408	1212	1037	879	1132
	4000	80	1257	1064	892	737	1014
	6000	78	1106	917	748	595	895
	8000	76	956	770	604	454	776
	10000	74	807	624	461	314	658
	12000	72	657	478	318	173	539
	14000	70	509	333	175	34	420
930	S.L.	82	1873	1649	1449	1269	1527
	2000	81	1703	1483	1286	1109	1393
	4000	79	1533	1317	1124	950	1260
	6000	77	1364	1151	962	791	1127
	8000	75	1196	987	800	632	994
	10000	73	1028	823	639	474	861
	12000	71	860	659	479	317	727
	14000	69	693	496	319	160	594

11. ENROUTE RATE OF CLIMB AT V_x

Power Setting: Maximum Continuous Power Flaps: Up Landing Gear: Up							
Weight [kg]	Pressure Altitude [ft]	Climb Speed V_x [KIAS]	Rate of Climb at V_x [ft/min]				
			Temperature [°C]				ISA
			-25	0	25	50	
1230	S.L.	72	1241	1073	924	789	982
	1000	72	1177	1011	863	729	932
	2000	72	1114	949	802	669	882
	3000	72	1050	887	741	609	832
	4000	72	986	825	680	550	782
	5000	72	923	763	619	490	732
	6000	71	860	701	559	431	682
	7000	71	797	639	498	371	632
1080	S.L.	72	1480	1295	1130	981	1194
	1000	72	1410	1226	1062	915	1139
	2000	72	1340	1158	995	848	1084
	3000	72	1269	1089	928	782	1029
	4000	71	1199	1020	861	717	973
	5000	71	1129	952	794	651	918
	6000	71	1059	884	727	585	863
	7000	71	990	815	660	520	808
930	S.L.	72	1787	1578	1391	1223	1463
	1000	72	1707	1500	1315	1148	1401
	2000	71	1628	1422	1239	1074	1339
	3000	71	1549	1345	1163	999	1277
	4000	71	1470	1268	1087	925	1215
	5000	71	1391	1190	1012	851	1153
	6000	71	1312	1113	936	777	1090
	7000	70	1233	1036	861	703	1028

12. ONE-ENGINE RATE OF CLIMB AT V_{YSE}

Power Setting: Maximum Continuous Power (operative engine) propeller feathered (inoperative engine)							
Flaps: Up							
Landing Gear: Up							
Weight	Pressure Altitude	Climb Speed V_{YSE}	Rate of Climb [ft/min]				
			Temperature [°C]				ISA
[kg]	[ft]	[KIAS]	-25	0	25	50	
1230	S.L.	84	330	230	142	62	176
	1000	83	292	193	106	26	147
	2000	82	254	157	69	-9	117
	3000	81	216	120	33	-44	87
	4000	80	179	83	-3	-80	58
	5000	79	141	46	-38	-115	28
	6000	79	104	10	-74	-150	-1
	7000	78	67	-27	-110	-185	-31
1080	S.L.	80	436	330	235	149	271
	1000	80	396	290	196	111	240
	2000	79	355	251	157	73	208
	3000	79	315	211	118	35	176
	4000	79	275	172	80	-3	145
	5000	79	234	132	41	-41	113
	6000	78	194	93	3	-78	81
	7000	78	154	54	-35	-116	50
930	S.L.	79	574	455	349	253	390
	1000	79	529	411	305	211	355
	2000	79	483	367	262	168	319
	3000	78	438	322	219	126	284
	4000	78	393	278	176	83	248
	5000	78	348	235	133	41	213
	6000	78	304	191	90	-1	178
	7000	77	259	147	47	-43	142

13. ONE-ENGINE RATE OF CLIMB AT V_{XSE}

Power Setting: Maximum Continuous Power (operative engine) propeller feathered (inoperative engine)							
Flaps: Up							
Landing Gear: Up							
Weight	Pressure Altitude	Climb Speed V_{XSE}	Rate of Climb at V_{XSE} [ft/min]				
			Temperature [°C]				ISA
[kg]	[ft]	[KIAS]	-25	0	25	50	
1230	S.L.	83	325	227	140	61	174
	1000	82	288	191	104	26	145
	2000	81	251	155	69	-9	116
	3000	81	214	118	33	-44	86
	4000	80	177	82	-2	-78	57
	5000	79	140	46	-38	-113	28
	6000	78	103	10	-73	-148	-1
	7000	77	66	-26	-108	-183	-30
1080	S.L.	79	424	321	229	147	265
	1000	79	385	283	192	110	234
	2000	79	346	245	155	73	204
	3000	79	307	207	117	37	173
	4000	79	268	169	80	0	143
	5000	78	229	131	43	-36	112
	6000	78	190	93	6	-73	81
	7000	78	152	55	-31	-109	51
930	S.L.	78	556	442	341	249	380
	1000	78	513	400	299	209	346
	2000	78	469	358	258	168	312
	3000	78	426	316	217	128	279
	4000	78	383	274	176	87	245
	5000	78	340	232	134	47	211
	6000	77	298	190	93	7	177
	7000	77	255	148	52	-34	143

14. CRUISE PERFORMANCES

Weight: 1150 kg (2535 lb)										
Pressure Altitude: 0 ft										
RPM *	MAP [inHg]	ISA – 30°C (-15°C)			ISA (15°C)			ISA + 30°C (45°C)		
		PWR	KTAS	F.C.** [lt/hr]	PWR	KTAS	F.C.** [lt/hr]	PWR	KTAS	F.C.** [lt/hr]
2250	29.5	103%	143	28.6	97%	145	27.1	92%	146	25.8
2250	28	88%	134	24.5	83%	136	23.2	79%	138	22
2250	26	69%	122	19.2	65%	124	18.2	62%	125	17.3
2250	24	59%	115	16.6	56%	116	15.7	53%	117	14.9
2250	22	46%	103	12.8	43%	103	12.1	41%	103	11.5
2250	20	39%	96	11	37%	95	10.4	35%	94	9.9
2100	28	84%	132	23.5	80%	134	22.2	76%	135	21.1
2100	26	66%	121	18.5	63%	122	17.5	60%	123	16.7
2100	24	57%	114	16	54%	114	15.1	52%	115	14.4
2100	22	43%	100	12.1	41%	100	11.5	39%	100	10.9
2100	20	37%	92	10.2	35%	91	9.7	33%	89	9.2
1900	26	61%	117	17.1	58%	118	16.2	55%	119	15.4
1900	24	53%	110	14.9	50%	111	14.1	48%	111	13.4
1900	22	41%	97	11.4	39%	97	10.8	37%	96	10.2
1900	20	35%	89	9.6	33%	88	9.1	31%	85	8.7

* Propeller RPM
 ** Fuel Consumption for each Engine

Weight: 1150 kg (2535 lb) Pressure Altitude: 3000 ft										
RPM *	MAP [inHg]	ISA – 30°C (-21°C)			ISA (9°C)			ISA + 30°C (39°C)		
		PWR	KTAS	F.C. ** [lt/hr]	PWR	TCAS	F.C. ** [lt/hr]	PWR	KTAS	F.C. ** [lt/hr]
2388	26.4	92%	141	25.7	87%	143	24.3	83%	144	23.1
2250	26.4	89%	139	25	85%	141	23.6	80%	143	22.4
2250	26	85%	137	23.9	81%	138	22.6	77%	140	21.5
2250	24	72%	128	20	68%	129	18.9	64%	130	18
2250	22	57%	116	16	54%	117	15.1	51%	118	14.3
2250	20	48%	108	13.4	45%	108	12.7	43%	108	12.1
2100	26.4	85%	137	23.9	81%	138	22.6	77%	140	21.4
2100	26	82%	134	22.8	77%	136	21.6	73%	137	20.5
2100	24	69%	125	19.2	65%	127	18.1	62%	128	17.2
2100	22	54%	114	15.2	51%	114	14.3	49%	115	13.6
2100	20	45%	104	12.6	43%	104	11.9	41%	104	11.3
1900	26.4	78%	132	21.9	74%	134	20.7	70%	135	19.6
1900	26	75%	130	20.9	71%	131	19.8	67%	132	18.8
1900	24	63%	121	17.7	60%	122	16.7	57%	123	15.9
1900	22	50%	110	14.1	48%	110	13.3	45%	110	12.6
1900	20	42%	101	11.7	40%	101	11.1	38%	100	10.6

* Propeller RPM
** Fuel Consumption for each Engine

Weight: 1150 kg (2535 lb) Pressure Altitude: 6000 ft										
RPM *	MAP [inHg]	ISA – 30°C (-27°C)			ISA (3°C)			ISA + 30°C (33°C)		
		PWR	KTAS	F.C. ** [lt/hr]	PWR	KTAS	F.C. ** [lt/hr]	PWR	KTAS	F.C. ** [lt/hr]
2388	23.6	83%	139	23.3	79%	141	22	75%	142	20.9
2250	23.6	81%	138	22.6	76%	139	21.4	73%	141	20.3
2250	22	68%	129	19.1	65%	130	18.1	61%	131	17.2
2250	20	57%	119	15.8	54%	120	14.9	51%	120	14.2
2250	18	46%	108	12.9	44%	108	12.2	41%	107	11.6
2100	23.6	77%	135	21.6	73%	137	20.4	69%	138	19.4
2100	22	65%	126	18.2	62%	127	17.2	59%	128	16.4
2100	20	54%	116	15	51%	116	14.1	48%	117	13.4
2100	18	44%	106	12.4	42%	106	11.7	40%	105	11.1
1900	23.6	71%	130	19.8	67%	132	18.7	64%	133	17.8
1900	22	60%	122	16.8	57%	123	15.8	54%	123	15
1900	20	50%	112	13.9	47%	112	13.1	44%	112	12.4
1900	18	41%	102	11.6	39%	102	10.9	37%	100	10.4

* Propeller RPM
** Fuel Consumption for each Engine

Section 5 - Performances

CRUISE PERFORMANCES

Weight: 1150 kg (2535 lb)

Pressure Altitude: 9000 ft

RPM *	MAP [inHg]	ISA – 30°C (-33°C)			ISA (-3°C)			ISA + 30°C (27°C)		
		PWR	KTAS	F.C.** [lt/hr]	PWR	KTAS	F.C.** [lt/hr]	PWR	KTAS	F.C.** [lt/hr]
2388	21.1	75%	137	20.9	71%	139	19.7	67%	140	18.7
2250	21.1	73%	136	20.3	69%	137	19.2	65%	138	18.2
2250	20	65%	130	18.3	62%	131	17.2	58%	131	16.3
2250	18	53%	118	14.9	50%	119	14	48%	118	13.3
2100	21.1	69%	133	19.4	65%	134	18.3	62%	135	17.4
2100	20	62%	127	17.4	59%	128	16.4	56%	128	15.6
2100	18	51%	116	14.2	48%	116	13.4	46%	116	12.7
1900	21.1	64%	128	17.8	60%	129	16.8	57%	130	15.9
1900	20	57%	122	16	54%	123	15.1	51%	123	14.3
1900	18	47%	112	13.2	44%	112	12.4	42%	111	11.8

* Propeller RPM

** Fuel Consumption for each Engine

Weight: 1150 kg (2535 lb)

Pressure Altitude: 12000 ft

RPM *	MAP [inHg]	ISA – 30°C (-39°C)			ISA (-9°C)			ISA + 30°C (21°C)		
		PWR	KTAS	F.C.** [lt/hr]	PWR	KTAS	F.C.** [lt/hr]	PWR	KTAS	F.C.** [lt/hr]
2388	18.8	67%	135	18.8	63%	136	17.7	60%	136	16.7
2250	18.8	65%	133	18.2	61%	134	17.2	58%	134	16.3
2250	18	60%	129	16.8	57%	129	15.9	54%	129	15
2100	18.8	62%	130	17.4	59%	131	16.4	56%	132	15.5
2100	18	58%	126	16.1	54%	126	15.2	51%	126	14.4
1900	18.8	57%	125	15.9	54%	126	15	51%	126	14.2
1900	18	53%	121	14.8	50%	121	13.9	47%	121	13.2

* Propeller RPM

** Fuel Consumption for each Engine

15. LANDING PERFORMANCES

Pressure Altitude [ft]		Distance [m]					ISA
		Temperature [°C]					
		-25	0	25	50		
S.L.	Ground Roll	199	219	239	259	231	
	At 50 ft AGL	308	334	359	384	349	
1000	Ground Roll	206	227	248	269	238	
	At 50 ft AGL	318	344	370	396	358	
2000	Ground Roll	214	236	257	279	245	
	At 50 ft AGL	328	355	382	408	367	
3000	Ground Roll	222	244	267	289	252	
	At 50 ft AGL	348	377	406	434	385	
4000	Ground Roll	230	254	277	300	260	
	At 50 ft AGL	348	377	406	434	385	
5000	Ground Roll	239	263	287	311	268	
	At 50 ft AGL	359	389	419	448	395	
6000	Ground Roll	248	273	298	323	276	
	At 50 ft AGL	371	402	432	463	405	
7000	Ground Roll	258	284	310	336	285	
	At 50 ft AGL	382	415	446	478	416	
8000	Ground Roll	268	295	322	349	294	
	At 50 ft AGL	395	428	461	494	427	
9000	Ground Roll	278	306	334	362	303	
	At 50 ft AGL	408	442	476	510	438	
10000	Ground Roll	289	318	348	377	313	
	At 50 ft AGL	421	457	492	527	450	

Weight = 1230 kg (2712 lb)

Flaps: *LAND*

Short Final Approach Speed = 70 KIAS

Throttle Levers: *Idle*

Runway: *Grass*

Corrections

Headwind: - 5m for each kt (16 ft/kt)

Tailwind: + 11m for each kt (36ft/kt)

Paved Runway: - 2% to Ground Roll

Runway slope: - 2.5% to Ground Roll for each +1%

Pressure Altitude [ft]		Distance [m]				
		Temperature [°C]				ISA
		-25	0	25	50	
S.L.	Ground Roll	175	192	210	227	203
	At 50 ft AGL	271	293	315	337	306
1000	Ground Roll	181	199	218	236	209
	At 50 ft AGL	279	302	325	348	314
2000	Ground Roll	188	207	226	245	215
	At 50 ft AGL	288	311	335	358	322
3000	Ground Roll	195	215	234	254	222
	At 50 ft AGL	306	331	356	381	338
4000	Ground Roll	202	223	243	263	228
	At 50 ft AGL	306	331	356	381	338
5000	Ground Roll	210	231	252	273	235
	At 50 ft AGL	315	342	368	394	347
6000	Ground Roll	218	240	262	284	243
	At 50 ft AGL	325	353	380	406	356
7000	Ground Roll	226	249	272	295	250
	At 50 ft AGL	336	364	392	420	365
8000	Ground Roll	235	259	283	306	258
	At 50 ft AGL	347	376	405	434	375
9000	Ground Roll	244	269	294	318	266
	At 50 ft AGL	358	388	418	448	385
10000	Ground Roll	254	280	305	331	275
	At 50 ft AGL	370	401	432	463	395

Weight = 1080 kg (2381 lb)

Flaps: LAND

Short Final Approach Speed = 70 KIAS

Throttle Levers: Idle

Runway: Grass

Corrections

Headwind: - 5m for each kt (16 ft/kt)

Tailwind: + 11m for each kt (36ft/kt)

Paved Runway: - 2% to Ground Roll

Runway slope: - 2.5% to Ground Roll for each +1%

Section 5 - Performances

LANDING PERFORMANCES

Pressure Altitude [ft]		Distance [m]				
		Temperature [°C]				ISA
		-25	0	25	50	
Weight = 930 kg (2051 lb) Flaps: LAND Short Final Approach Speed = 70 KIAS Throttle Levers: Idle Runway: Grass						
Corrections Headwind: - 5m for each kt (16 ft/kt) Tailwind: + 11m for each kt (36ft/kt) Paved Runway: - 2% to Ground Roll Runway slope: - 2.5% to Ground Roll for each +1%						
S.L.	Ground Roll	150	166	181	196	175
	At 50 ft AGL	233	252	271	290	264
1000	Ground Roll	156	172	187	203	180
	At 50 ft AGL	240	260	280	299	270
2000	Ground Roll	162	178	194	211	185
	At 50 ft AGL	248	268	288	309	277
3000	Ground Roll	168	185	202	219	191
	At 50 ft AGL	263	285	307	328	291
4000	Ground Roll	174	192	209	227	197
	At 50 ft AGL	263	285	307	328	291
5000	Ground Roll	181	199	217	235	203
	At 50 ft AGL	272	294	317	339	299
6000	Ground Roll	188	207	226	244	209
	At 50 ft AGL	280	304	327	350	307
7000	Ground Roll	195	215	234	254	215
	At 50 ft AGL	289	313	338	361	315
8000	Ground Roll	203	223	243	264	222
	At 50 ft AGL	299	324	349	373	323
9000	Ground Roll	210	232	253	274	229
	At 50 ft AGL	308	334	360	386	331
10000	Ground Roll	219	241	263	285	237
	At 50 ft AGL	319	346	372	399	340

Section 5 - Performances

LANDING PERFORMANCES

16. BALKED LANDING CLIMB GRADIENT

Flight conditions (ISA and SL):

Weight:	<i>1230 kg (2712 lb)</i>
Throttle levers	<i>Both FULL FORWARD</i>
Flaps	<i>T/O</i>
Landing gear	<i>DOWN</i>
Weight	<i>MTOW 1230kg (2712 lb)</i>
Speed	<i>72 KIAS</i>
Climb gradient	<i>9.4% (5.4°)</i>

17. NOISE DATA

Noise level, determined in accordance with ICAO/Annex 16 4th Ed., July 2005, Vol. I°, Chapter 10, is **72.82** dB(A).

INTENTIONALLY LEFT BLANK

SECTION 6 – WEIGHT and BALANCE

INDEX

1. INTRODUCTION	3
2. WEIGHING PROCEDURES	4
2.1. Preparation	4
2.2. Levelling	4
2.3. Weighing	4
2.4. Determination of C.G. location	4
2.5. Weighing record.....	5
2.6. Weighing record (II).....	5
3. WEIGHTS AND C.G.....	7
4. BAGGAGE LOADING	8
5. EQUIPMENT LIST	10

INTENTIONALLY LEFT BLANK

1. INTRODUCTION

This section describes the procedure for establishing the basic empty weight and the moment of the aircraft. Loading procedure information is also provided.

NOTE

Aircraft must be operated in accordance with the limits concerning the maximum takeoff weight and CG excursion as reported in Flight Manual Section 2.

Pilot is responsible for checking the weight and CG excursion are compliant with the related limits. CG excursion and weight limits are reported in Section 2 – Limitations.

2. WEIGHING PROCEDURES

2.1. PREPARATION

- Carry out weighing procedure inside closed hangar
- Remove from cabin any object unintentionally left
- Make sure Flight Manual and mandatory documents are on board
- Align nose wheel
- Drain fuel via the specific drain valve
- Oil, hydraulic fluid and coolant liquid at the operating levels
- Move sliding seats to most forward position
- Raise flaps to fully retracted position
- Place control surfaces in neutral position
- Place scales (min. capacity 300 kg) under each wheel

2.2. LEVELLING

- Level the aircraft (the reference for longitudinal levelling is made putting a spirit-level on the cabin floor as shown in the Aircraft Maintenance Manual).
- Adjust longitudinal attitude deflating nose tire

2.3. WEIGHING

- Record weight shown on each scale
- Repeat weighing procedure three times
- Calculate empty weight

2.4. DETERMINATION OF C.G. LOCATION

- Drop a plumb bob tangent to the wing leading edge and trace a reference mark on the floor (see Figure on Para. 2.5 or 2.6)
- Repeat the operation for other wing
- Stretch a taught line between the two marks
- Measure the distance between the reference line and both main and nose wheel axis (A and B distances respectively)
- Using recorded data it is possible to determine the aircraft C.G. location and the aircraft moment (see following table)

2.5. WEIGHING RECORD

Model **P2006T** S/N: _____ Weighing no. _____ Date: _____

Datum: leading edge vertical

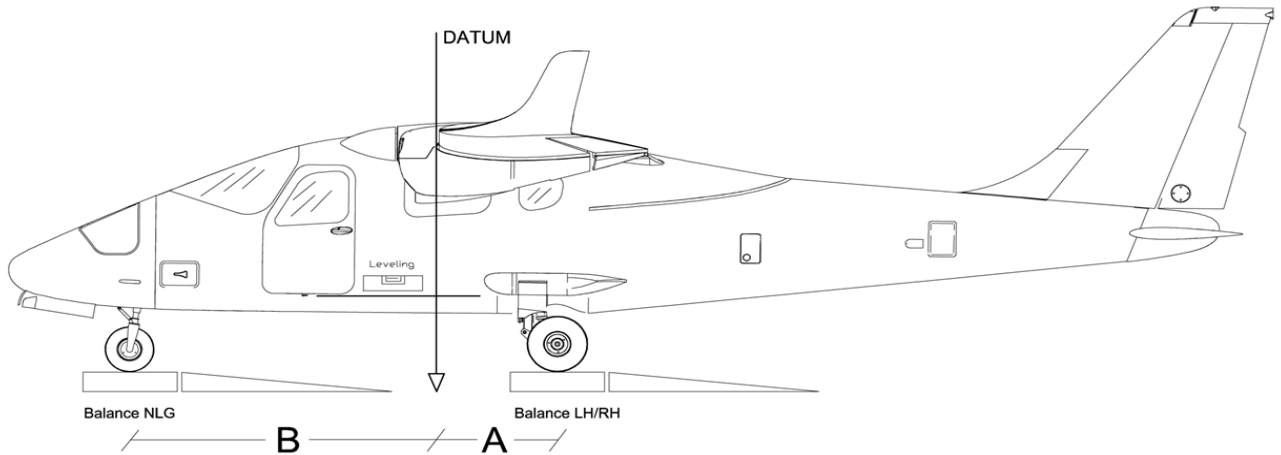

	<i>Kg or Lbs</i>		<i>Meters or feet</i>
Nose wheel weight	$W_1 =$	Plumb bob distance LH wheel	$A_L =$
LH wheel weight	$W_L =$	Plumb bob distance RH wheel	$A_R =$
RH wheel weight	$W_R =$	Average distance $(A_L + A_R)/2$	$A =$
$W_2 = W_L + W_R =$		Plumb bob distance from nose wheel	$B =$

Empty weight $W_e = W_1 + W_2 =$ [kg] or [lbs]

$D = \frac{W_2 \cdot A - W_1 \cdot B}{W_e} =$ [m] or [Ft] $D\% = \frac{D}{1.339} \cdot 100 =$

Empty weight moment: $M = (D \cdot W_e) =$ [m · Kg] or [Ft · Lbs]

Maximum takeoff weight	$W_T =$	[kg] or [lbs]	Signature _____
Empty weight	$W_e =$	[kg] or [lbs]	
Max. useful load $W_T - W_e$	$W_u =$	[kg] or [lbs]	

2.6. WEIGHING RECORD (II)

Model **P2006T** S/N: _____ Weighing no. _____ Date: _____

Datum: leading edge vertical

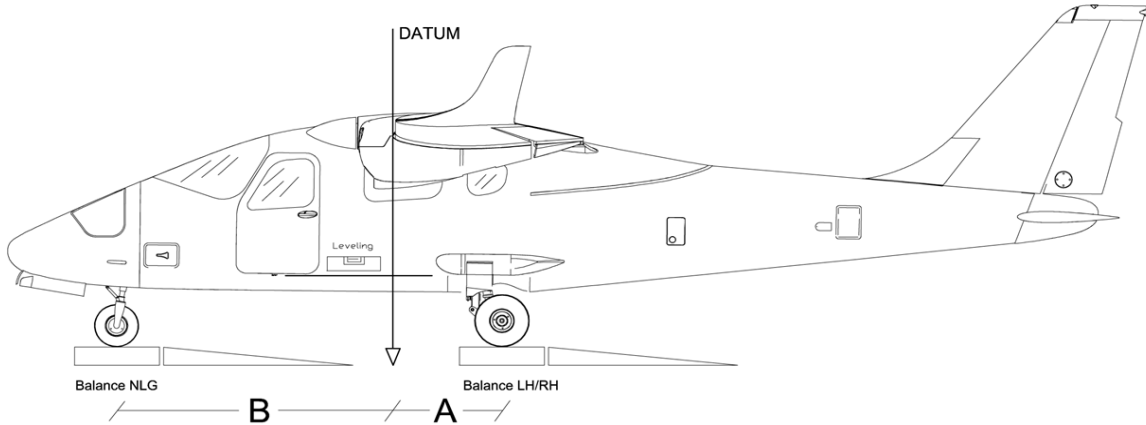

<i>Kg or Lbs</i>		<i>Meters or feet</i>	
Nose wheel weight	$W_1 =$	Plumb bob distance LH wheel	$A_L =$
LH wheel weight	$W_L =$	Plumb bob distance RH wheel	$A_R =$
RH wheel weight	$W_R =$	Average distance $(A_L + A_R)/2$	$A =$
$W_2 = W_L + W_R =$		Plumb bob distance from nose wheel	$B =$

Empty weight $W_e = W_1 + W_2 =$ [kg] or [lbs]

$D = \frac{W_2 \cdot A - W_1 \cdot B}{W_e} =$ [m] or [Ft] $D\% = \frac{D}{1.339} \cdot 100 =$

Empty weight moment: $M = (D \cdot W_e) =$ [m · Kg] or [Ft · Lbs]

Maximum takeoff weight	$W_T =$	[kg] or [lbs]	Signature _____
Empty weight	$W_e =$	[kg] or [lbs]	
Max. useful load $W_T - W_e$	$W_u =$	[kg] or [lbs]	

3. WEIGHTS AND C.G.

C.G. position can be defined by means of the chart below.

The pilot is responsible for ensuring the correct useful load loading.

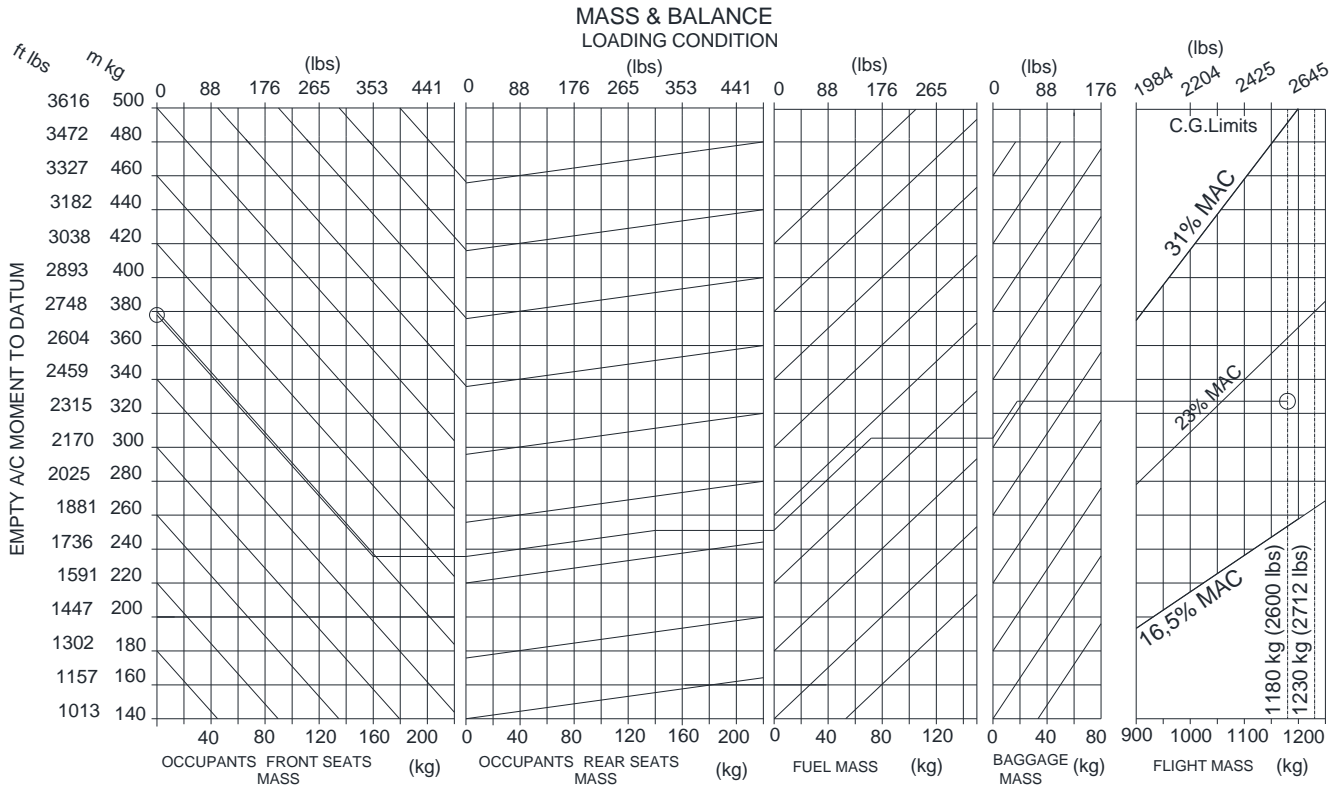

Figure 1

Example

A/C empty mass moment	378 kgm
A/C empty mass	790 kg
Occ. front seats	160 kg
Occ. rear seats	140 kg
Fuel	72kg
Baggage	18 kg
A/C T.O. weight	1180kg

4. BAGGAGE LOADING

The baggage loading in the dedicated compartment must be carried out in accordance with diagram addressed on PAR. 03 and with C.G. excursion and weight limitations reported in Section 2.

Pilot is provided with a red tie-down net and snap fasteners allowing for securing the loads on the compartment floor.



Loading the baggage, make sure that you correctly stretched the net which must be secured to the four vertices of the floor.

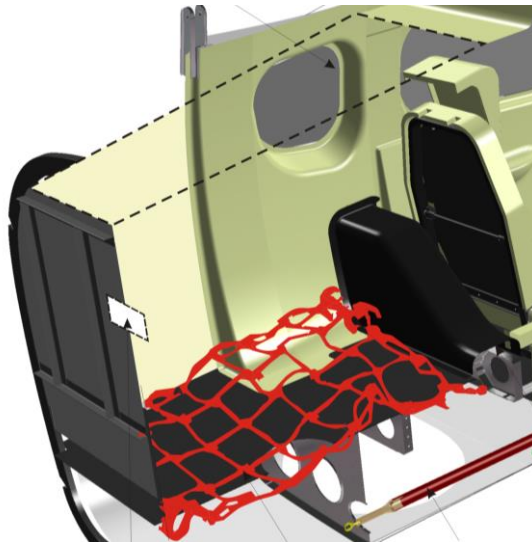

INTENTIONALLY LEFT BLANK

5. EQUIPMENT LIST

The following is a list of equipment which may be installed in the *P2006T*.
The items marked with an "X" were installed on the airplane described at the beginning of the list and they are included in the Basic Empty Weight.

It is the owner's responsibility to retain this equipment list and amend it to reflect changes in equipment installed in this airplane.

EQUIPMENT LIST		AIRCRAFT S/N _____	DATE:		
REF.	DESCRIPTION	P/N	INST	WEIGHT [kg]	ARM [M]
INSTRUMENTATION					
A1	GARMIN G950 IFDS				
A2	SOFTWARE SD CARD P/N				
A3	2 nd airspeed indicator – UMA T6-311 – 200			0.37	-1.4
A4	2 nd airspeed indicator - UMA T6-311 –			0.37	-1.4
A5	2 nd attitude indicator - Kelly Manufacturing RCA26AK-3			1	-1.4
A6	2 nd altimeter - Altimeter - United Instruments 5934PM-3A84 01770028-05			0.6	-1.4
A7	Turn and bank indicator – RCA 83A-11			1.2	-1.4
A8	Mid-Continent MD302 stand-by instrument			0.73	-1.4
AVIONICS & MISCELLANEOUS					
B1	Garmin GNS-430W GPS/WAAS COMM/NAV			3	-1.4
B2	Garmin GNS-530W GPS/WAAS COMM/NAV			3,18	-1.4
B3	Garmin GMA340 audio panel			0.8	-1.4
B4	Garmin GMA347 audio panel			0.8	-1.4
B5	Garmin SL30 VHF COMM/NAV			1.3	-1.4
B6	Transponder-Garmin GTX328			1.9	-1.4
B7	Transponder-Garmin GTX330			1.5	-1.4
	Transponder-Garmin GTX33			1.5	-1.4
B8	Becker BXP 6401-2-(01) Mode S transponder			0.8	-1.4
B9	Vor/Loc/GS Indicator–Garmin GI106A			0.4	-1.4
B10	Vor/Loc/GS Indicator -MID Continental MD 200-306			0,4	-1,44
B11	Directional Gyro - Kelly Manufacturing RCA15AK-1			1	-1.4
B12	Directional Gyro - Kelly Manufacturing RCA15AK-16			1	-1.4
HONEYWELL Bendix/King KCS 55A Compass System					
B13	KI 525A Pictorial Navigation Indicator			1.53	-1.4
B14	KG 102A Directional Gyro			1.95	1
B15	KA 51B Slaving Control and Compensator Unit			0.1	-1.4
B16	KMT 112 Magnetic Slaving Transmitter			0.15	2.2
HONEYWELL Bendix/King ADF KR87 system:					
B17	ADF KR87 receiver			1.5	1
B18	Indicator KI 227			0.3	-1.4

EQUIPMENT LIST		AIRCRAFT S/N _____	DATE:		
REF.	DESCRIPTION	P/N	INST	WEIGHT [kg]	ARM [M]
<i>AVIONICS & MISCELLANEOUS (CONT'D)</i>					
B19	Indicator KI 229			1.3	-1.4
B20	Static inverter Marathon PC-50			2	1
HONEYWELL Bendix/King DME KN 63 system					
B21	Indicator DME KDI 572			0.4	-1.4
B22	Transceiver DME KN 63			1.3	1
S-TEC Fifty Five X Autopilot System					
B23	Turn coordinator S-TEC 6405-14L (Mid Continent 1394T100-14RB)			0.81	-1.4
	Turn coordinator Mid Continent 1394T100-7Z			0.81	-1.4
B24	PRGMR/CMPTR 01192-0-2TF			1.36	-1.4
B25	Roll servo 0105-5-R9			1.31	-0.71
B26	Pitch servo 0107-11-P4			1.31	3.55
B27	Altitude Transducer 0111			0.2	-1.9
B28	Pitch Trim servo S-TEC 0105- T11			1.3	2.8
B29	ELT Adams Aviation Artex ME406			0.9	0.8
B30	LH Front and rear seat GEVEN E5-01-003-T01 or E5-01-007-T01 or E5-01-009-T03			9	- 0.893
B31	RH Front and rear seat GEVEN E5-01-004-T01 or E5-01-008-T01 or E5-01-010-T03			9	0.226
B32	Fire extinguisher Fire Fighting Enterprises Ltd BA51015-3			2	-1.5
B33	First aid kit Euroferramenta s.r.l. FIA270160			0.2	0.8
B34	Torch			0.15	-1.5
B35	Battery GILL35 - 13Volt - 23Ah			12.2	3.7
B36	ELT KANNAD 406			0.9	0.8
B37	Fire extinguisher H3R-Aviation RTA-600			0.8	-1.5

INTENTIONALLY LEFT BLANK

INTENTIONALLY LEFT BLANK

SEZIONE 7 – AIRFRAME and SYSTEMS DESCRIPTION**INDEX**

1. INTRODUCTION	3
2. AIRFRAME.....	3
3. POWERPLANT	9
4. PEDESTAL CONTROLS.....	12
5. CABIN OVER-HEAD PANEL CONTROLS.....	15
6. INTERNAL LIGHTS.....	16
7. EXTERNAL LIGHTS	17
8. FUEL SYSTEM.....	19
9. LANDING GEAR SYSTEM	21
10. BRAKES.....	25
11. VENTILATION	26
12. CABIN HEAT.....	26
13. SEATS AND SAFETY BELTS	26
14. DOORS.....	27
15. BAGGAGE COMPARTMENT.....	28
16. PLACARDS	31
17. INSTRUMENTS PANEL.....	37
18. ELECTRICAL SYSTEM.....	40

INTENTIONALLY LEFT BLANK

1. INTRODUCTION

This section provides aircraft and systems description and operation.

2. AIRFRAME

2.1. WING

Each wing consists of a central light alloy torque box which carries all the wing bending, shear and torque loads; an aluminium leading edge is attached to the front spar while flap and aileron are hinged to the rear spar.

The torque box houses an integrated fuel tank and supports the engine mount.

Flap and aileron, respectively located inboard and outboard of wing and made up of light alloy, are constructed with a central spar to which front and rear ribs are jointed. Wrapped-around aluminium stressed skin panels cover all the structures. Steel alloy attachments connect left and right wing to each other.

Following figure shows the left wing fitted with the engine nacelle, fuel tank and composite winglet. Steel alloy attachments link left and right wing to each other.

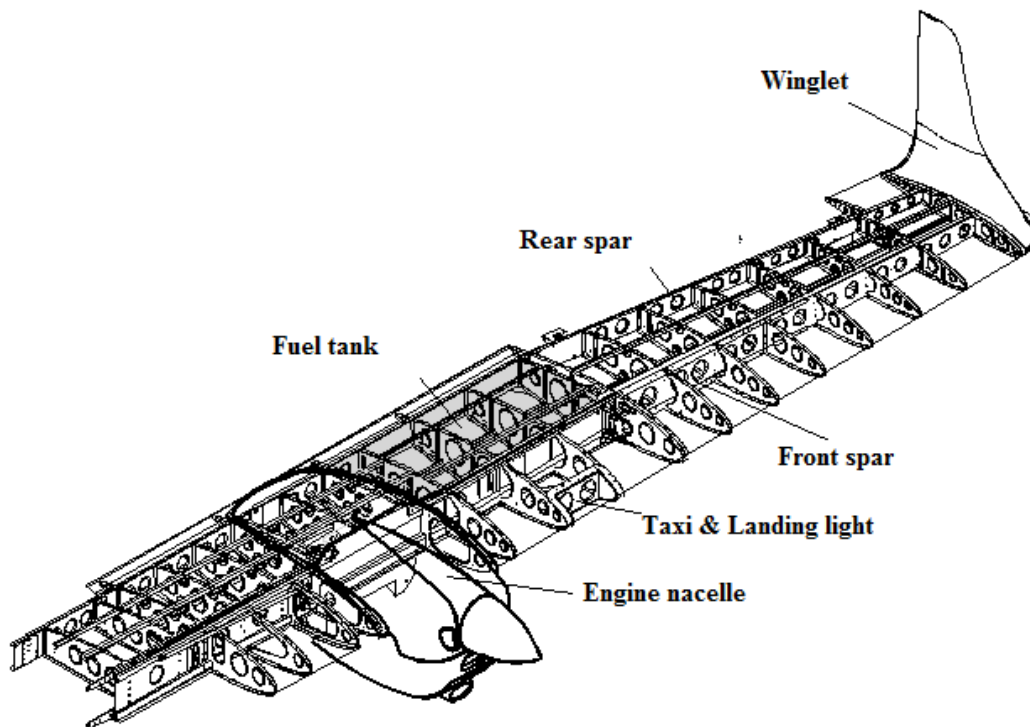

Figure 1. – Left wing structure

2.2. FUSELAGE

The fuselage is constituted by a light-alloy semi-monocoque structure wrapped-around by stressed skin panels. Radome and stern fairing are of composite material. Cabin and baggage compartment floor is a warping of beams and keelsons supporting the seats guides and other components.

Two spar frames support on the top the wings attachments and on the bottom the *sponson* beams sustaining the main landing gear. The forward frame, to which radome is connected, supports a steel trestle to which the nose landing gear is connected.

The front and rear seats access occur by means of two doors located in the opposite sides of the fuselage; a ditching emergency exit is available on the top of the cabin. In tail cone, two spar frames support the horizontal and vertical empennages attachments.

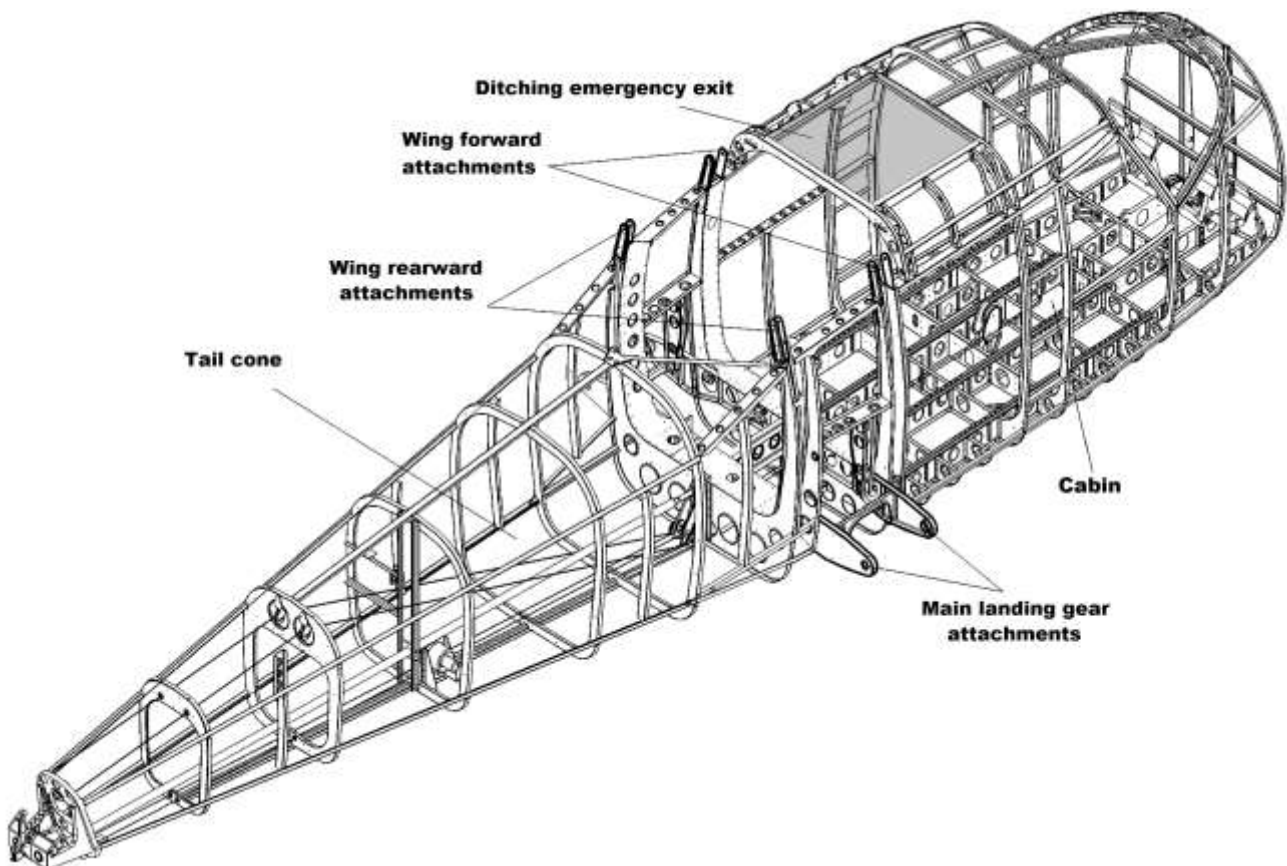

Figure 2. – Fuselage structure

2.3. EMPENNAGES

The vertical tail is entirely metallic: vertical fin is made up of a twin spar with aluminium alloy stressed skin. Rudder, providing directional control of the airplane, is made up of aluminium alloy.

The rudder is connected to the vertical tail at two hinge points. A trim tab system increases directional stability of the airplane.

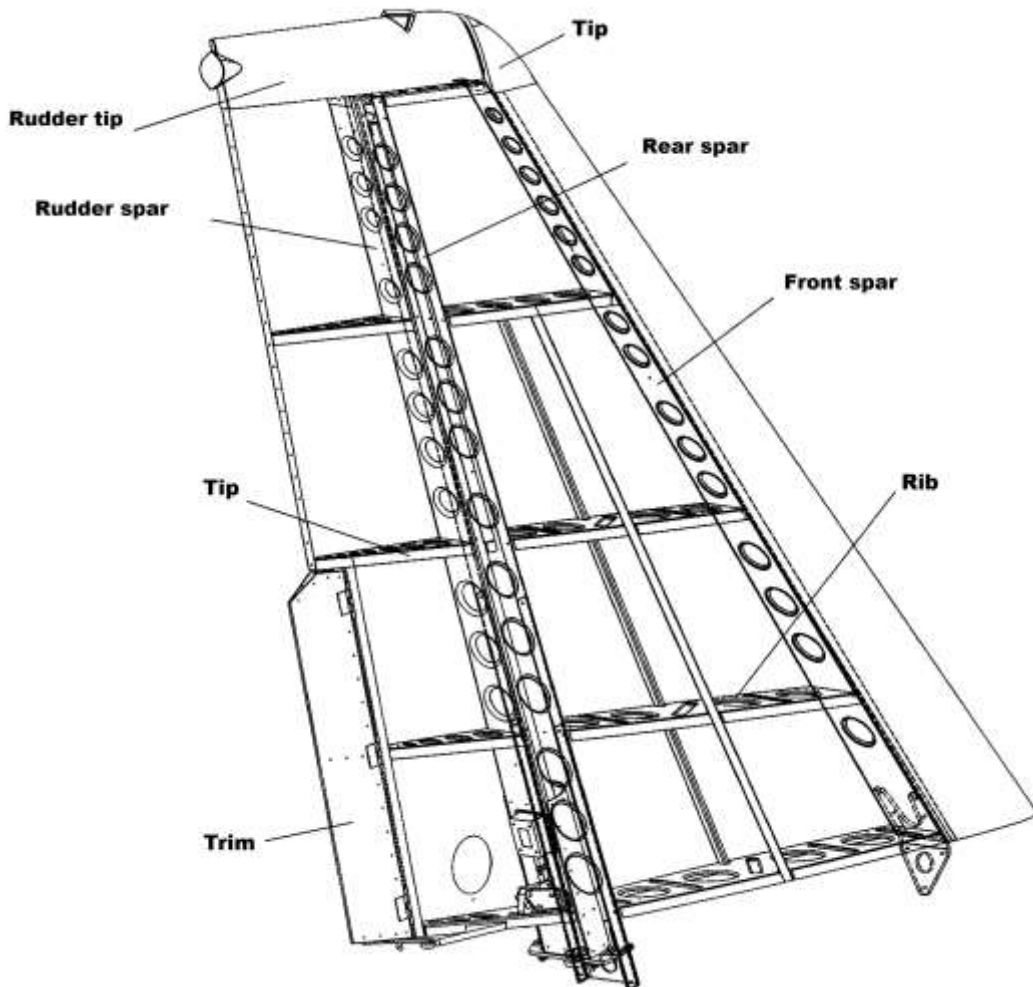

Figure 3. – Vertical empennage structure

The horizontal empennage is an all-moving type (stabilator); its structure consists of a twin spar to which front and rear ribs are jointed and it is covered by stressed aluminium alloy skin. The trim tab completes the assy.

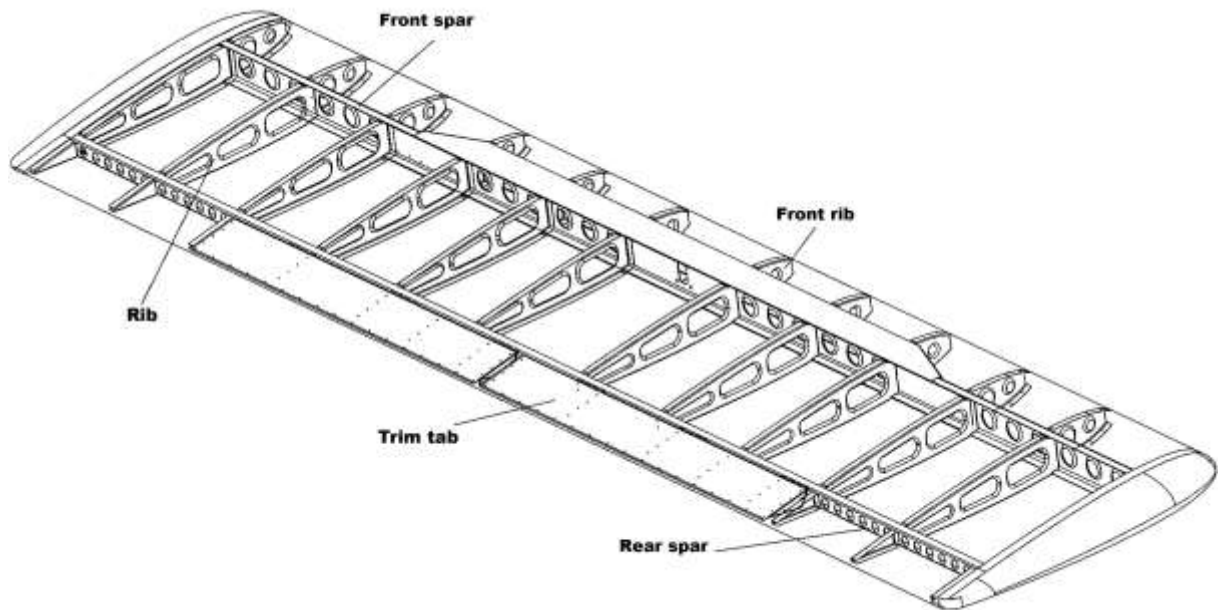

Figure 4. – Stabilator structure

2.4. FLIGHT CONTROLS

The main flight control system controls the airplane in three axes. All primary controls (ailerons, rudder and stabilator) are manually operated by a conventional control column and rudder pedals, pulleys, cables, bellcranks and rods.

The secondary flight controls consist of a two-axis trim system and a flaps system.

Complete dual controls are provided for pilot and co-pilot.

Longitudinal control acts through a system of push-pull rods connected to the control column and moving the stabilator whose anti-tab winglet works also as trim tab. Autopilot pitch servo (if installed) is connected to the push-pull rods system through driving cables.

Longitudinal trim is performed by a small tab positioned on the stabilator and manually operated via a control wheel positioned between the two crew seats. As optional, it is available an electrically operated longitudinal trim which it is also controlled by the autopilot system, when installed.

Trim position is monitored by an indicator on the instrument panel. A trim disconnect toggle switch is provided.

Ailerons control is of mixed type with push-rods and cables; a cable control circuit is confined within the cabin and it is connected to a pair of push-pull rod systems positioned in each main wing which control ailerons differentially.

The U-shaped control wheels, hinged on the top of the control column, control the ailerons. Control wheel motion is transferred to the ailerons through a cable loop, up to the interconnecting rod linking the two push-pull rod systems which finally transmit the motion to the ailerons.

When either aileron control wheel is rotated, the crossover cable rotates the other control wheel.

The left aileron has a trim tab adjustable on ground: its deflection allows for lateral trimming of the airplane.

Both flaps are extended via a single electric actuator controlled by a switch on the instrument panel. Flaps act in continuous mode; the analogue indicator displays three markings related to 0°, takeoff (T/O) and landing (FULL) positions.

An aural warning is generated whenever the flaps are lowered to the FULL position and the landing gear is not down-locked.

Rudder is operated through a cable system. A rudder trim tab allows aircraft directional trimming, especially in case of OEI operation: it is electrically operated via a switch located on the central console placed between crew seats.

Its position is monitored by an indicator on the instrument panel. A trim disconnect toggle switch is provided.

INTENTIONALLY LEFT BLANK

3. POWERPLANT

P2006T is equipped with two four-cylinder four-stroke Rotax 912S engines of 98hp (73kW) each, both rotating clockwise. These are partially liquid cooled and they feature an integrated reduction gear driving constant speed propellers with pitch feathering devices.

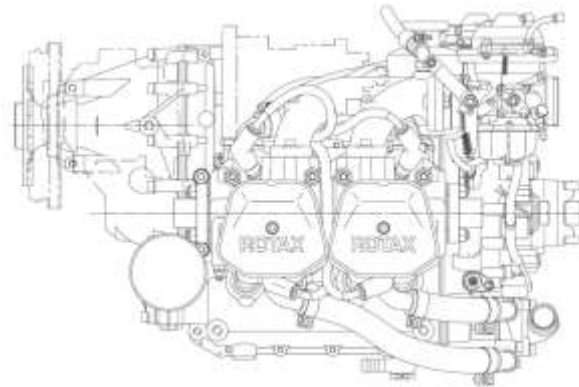

Figure 5. – Rotax 912S

Cooling system is designed for liquid cooling of the cylinders heads and ram-air cooling of the cylinders. The liquid system is a closed circuit with an overflow bottle and an expansion tank.

The coolant flow is forced by a water pump, driven from the camshaft, from the radiator to the cylinder heads. From the top of the cylinder heads the coolant passes on to the expansion tank (item 1, Figure below). Since the standard location of the radiator (2) is below engine level, the expansion tank, located on top of the engine, allows for coolant expansion.

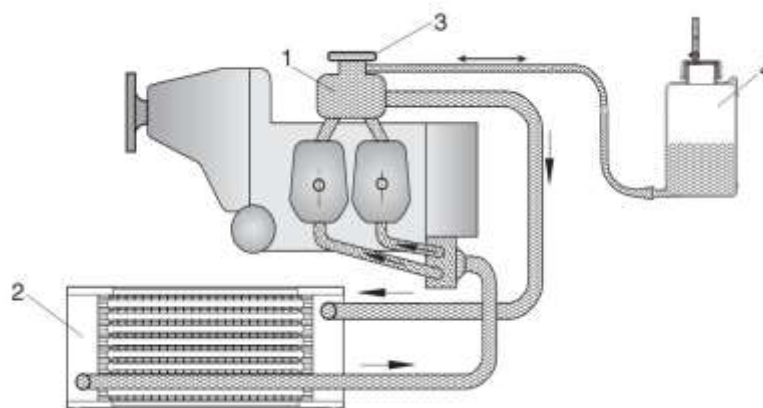

Figure 6. – Liquid cooling system schematic

The expansion tank is closed by a pressure cap (3) fitted with pressure relief valve and return valve. At temperature rise and expansion of the coolant, the pressure relief valve opens and the coolant will flow via a hose at atmospheric pressure to the transparent overflow bottle (4). Once cooled down, the coolant will be sucked back into the cooling circuit.

The engine is provided with a dry sump forced lubrication system with an oil pump with integrated pressure regulator. A thermostatic valve regulates the oil flow to the heat exchanger (oil radiator) on the basis of oil temperature: this allows the engine starting in cold conditions.

The oil tank is installed behind the firewall protected from heat sources. Some holes on the bracket structure allow for air ventilation

The reservoir is fitted with a dipstick; a hose, immediately located beneath the filler cap, allows for oil relief discharged in a safe zone in the cowling, far from exhausts and other heat sources.

Following powerplant instruments are provided:

- LH and RH RPM Indicator
- LH and RH Manifold Pressure Indicator
- LH and RH Oil Pressure Indicator
- LH and RH Oil Temperature Indicator
- LH and RH Cylinder Head Temperature Indicator

3.1. ENGINE FEATURES

Manufacturer	Bombardier-Rotax GmbH
Model	912 S3
Certification basis	FAR 33, Amendment 15
Type Certificate	EASA TCDS no. E.121 dated 1st April 2008
Engine type	4 cylinders horizontally opposed with 1352 c.c. of overall displacement, liquid cooled cylinder heads, ram-air cooled cylinders, two carburetors, integrated reduction gear box with shock absorber.
Maximum power (at declared rpm)	73.5 kW (98.6hp) @ 5800 rpm –5 min. maximum 69.0 kW (92.5hp) @ 5500 rpm (continuous)

3.2. PROPELLER FEATURES

Manufacturer	MT Propeller
Type certificate	LBA 32.130/086 (MTV-21 series)
Model	MTV-21-A-C-F/CF178-05
Blades/hub	2 wood/composite blades, aluminium hub
Diameter	1780 mm (no reduction allowed)
Type	Variable pitch hydraulically controlled

3.3. PROPELLER GOVERNOR FEATURES

Manufacturer	MT Propeller
Model	P-875-12
Type	Hydraulic

4. PEDESTAL CONTROLS

Following picture shows the controls installed on the central pedestal.

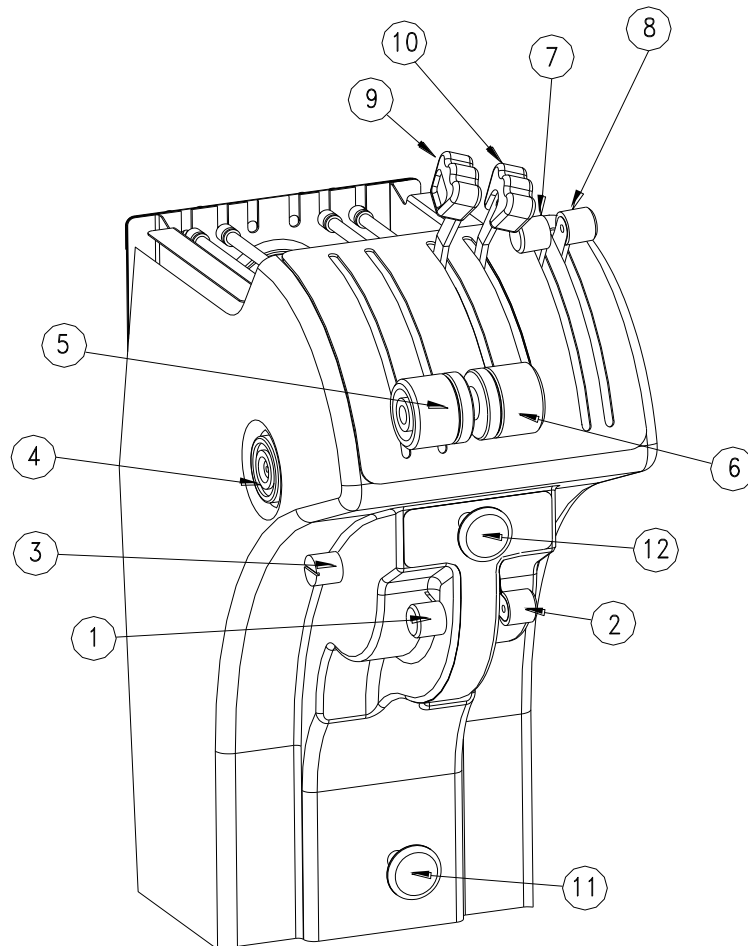

Figure 7. – Pedestal controls

No	Description
1 and 2	Choke control
3	Choke friction knob
4	Upper levers friction knob
5-6	LH and RH Throttle lever
7-8	LH and RH Carburetor Heating lever
9-10	LH and RH Propeller Pitch Control lever
11	Parking brake
12	Windshield defrost control knob

NOTE

Aircraft not embodying the Design Change 2006/66 “New Powerplant control setting layout” or the SB 039-CS “P2006T New powerplant controls layout” feature a different pedestal levers layout: propeller and carb. heat levers position are inverted.

It is possible to adjust the throttle, propeller and carburettor heat levers friction by appropriately tightening the friction knob located on the central console.

A similar device is provided for engine choke controls.

Carburettor heat control knobs are located between throttle and propellers levers; when the knobs are fully pulled backwards, carburettors receive maximum hot air.

During normal operations, the knobs are fully forward set (carburettors heating set to OFF).

The console houses also the parking brake and windshield defrost control knobs.

INTENTIONALLY LEFT BLANK

5. CABIN OVER-HEAD PANEL CONTROLS

Following picture shows the controls installed on the cabin over-head panel.

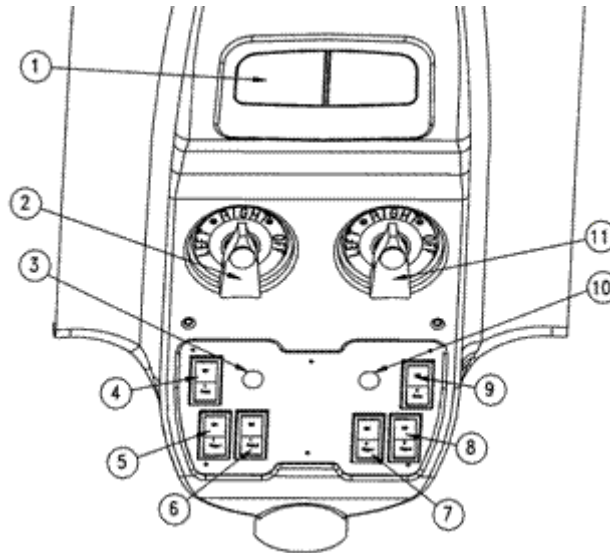

Figure 8. – Cabin head panel controls

No	Description
1	Cabin Light
2	LH Fuel selector valve
3	LH Electric Starter
4	LH electric fuel pump
5	LH Engine ignition 1
6	LH Engine ignition 2
7	RH Engine ignition 1
8	RH Engine ignition 2
9	RH electric fuel pump
10	RH Electric Starter
11	RH Fuel selector valve

6. INTERNAL LIGHTS

Internal lights system is composed by following equipment:

- **Cabin light**, providing lighting for crew and passengers compartment;
- **Instruments lights**, which in turn are composed by three sub-systems each one fitted with dimming device:
 - Switches built-in lights
 - Avionics lights
 - Cockpit lights
- **Emergency light**

The **cabin light** is a ceiling light, fitted with control switches, located on the over-head panel in correspondence of the crew seats.

About the **instrument lights** (controlled by a switch on the RH instrument panel), the switches built-in lights concern the instrument panels switches lighting, the avionics lights concern the avionic equipment lighting and the cockpit lights concern two lights located on the over-head panel illuminating LH and RH instrument panels (see Figure below).

All above mentioned lights are supplied by the battery bus apart from the **Emergency light** which is directly connected to the battery. It is a five-leds light located in the over-head panel (see Figure below) controlled by a switch installed on the LH breakers rack.



Figure 9. – Over-head panel lights arrangement

7. EXTERNAL LIGHTS

External lights system consists of the following equipment (see Figure below):

- **NAV Lights:** they provide, by means of three position lights, the aircraft flight direction identification.
- **Strobe Lights:** they provide aircraft identification to prevent collision. They are located, like the above mentioned NAV lights, on the winglets and on the top of the vertical fin.
- **Taxi Light:** supports taxi maneuvering on the ground at night. It is installed on the left wing leading edge.
- **Landing Light:** provides ground reference information during final approach, touchdown, ground roll and take off and illuminates any major obstructions in the airplane approach glide path or on runway at night. It is installed on the left wing leading edge.

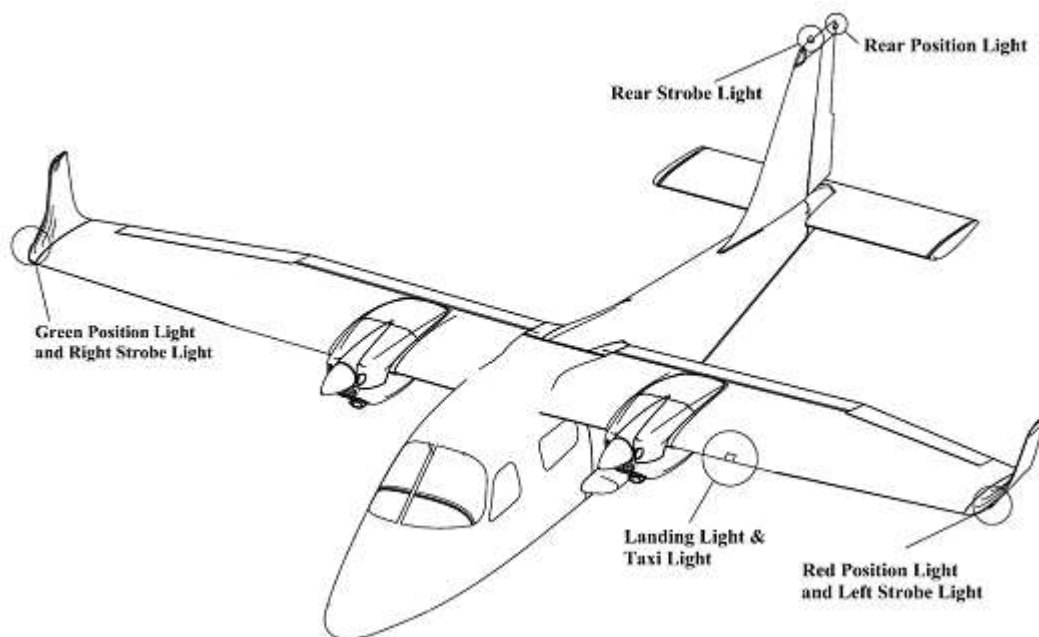

Figure 10. – External lights arrangement

All mentioned lights, whose circuits are protected by dedicated breakers, are activated by the related switches on the right instrument panel: see below.



Figure 11. – Lights switches panel

8. FUEL SYSTEM

Fuel system consists of two integrated tanks inside the wing torque boxes and fitted with inspection doors.

Each fuel tank has a capacity of 100 litres and is equipped with a vent valve (its outlet is located on the lower wing skin) and a sump fitted with a drain valve for water/moisture drainage purposes.

An electric fuel pump feeds the pertinent engine in case of engine-driven pump failure. The fuel Gascolator (a sediment-filter bowl) is located beneath the engine nacelle, between the fuel tank and the electrical pump, in correspondence of the fuel system lowest point. It is fitted with a drain valve which allows for the overall fuel line drainage.

Fuel quantity indicators and fuel pressure indicators for each engine are located on the RH instrument panel.

In normal conditions, to supply fuel to engines, each engine pump sucks fuel from the related tank; crossfeed is allowed by fuel valves located on the front spar and controlled by Bowden cables from the fuel selectors located on the cabin overhead panel.

Left fuel selector manages the left engine feeding, allowing fuel supply from the left fuel tank or from the right one (crossfeed).

Right fuel selector manages the right engine feeding, allowing fuel supply from the right fuel tank or from the left one (crossfeed).

Each selector can be set in OFF position only pulling and simultaneously rotating the lever: this avoids an unintentional operation.



Use of Aviation Fuel Avgas 100LL results in greater wear of valve seats and greater combustion deposits inside cylinders due to higher lead content. Make reference to Rotax Maintenance Manual who provides dedicated checks due to the prolonged use of Avgas.

System schematic is shown on the following Figure.

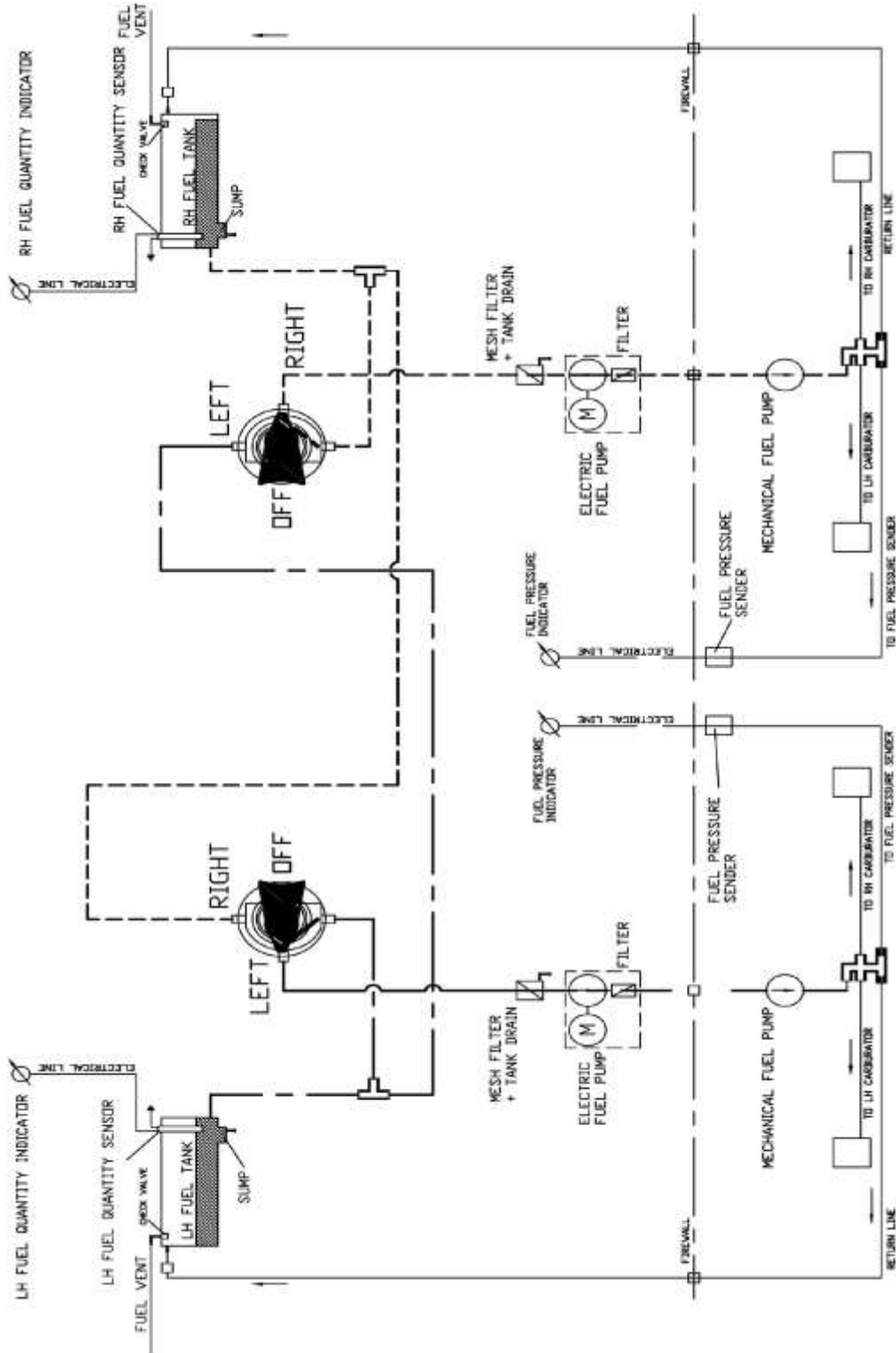

Figure 12. – Fuel system schematic

9. LANDING GEAR SYSTEM

The landing gear retraction system is of electro-hydraulic type, powered by a reversible pump which is electrically controlled by the LG control knob located on the LH instrument panel and by the legs position micro switches: these ones allow for detecting landing gear “down-locked” and “up” positions and for alerting the pilot by aural means should the approach and landing configuration be incorrect, in terms of flaps/throttle levers/landing gear position, in order to avoid an unintentional gear-up landing.

The system operates in two modes: normal and emergency.

Normal operation provides gear extension and retraction by means of hydraulic jacks. Gears extension is helped by gravity also.

Emergency operation only provides landing gear extension by means of a hydraulic accumulator which discharges pressurized oil in the above mentioned jacks.

HYDRAULIC SCHEMATIC DIAGRAM

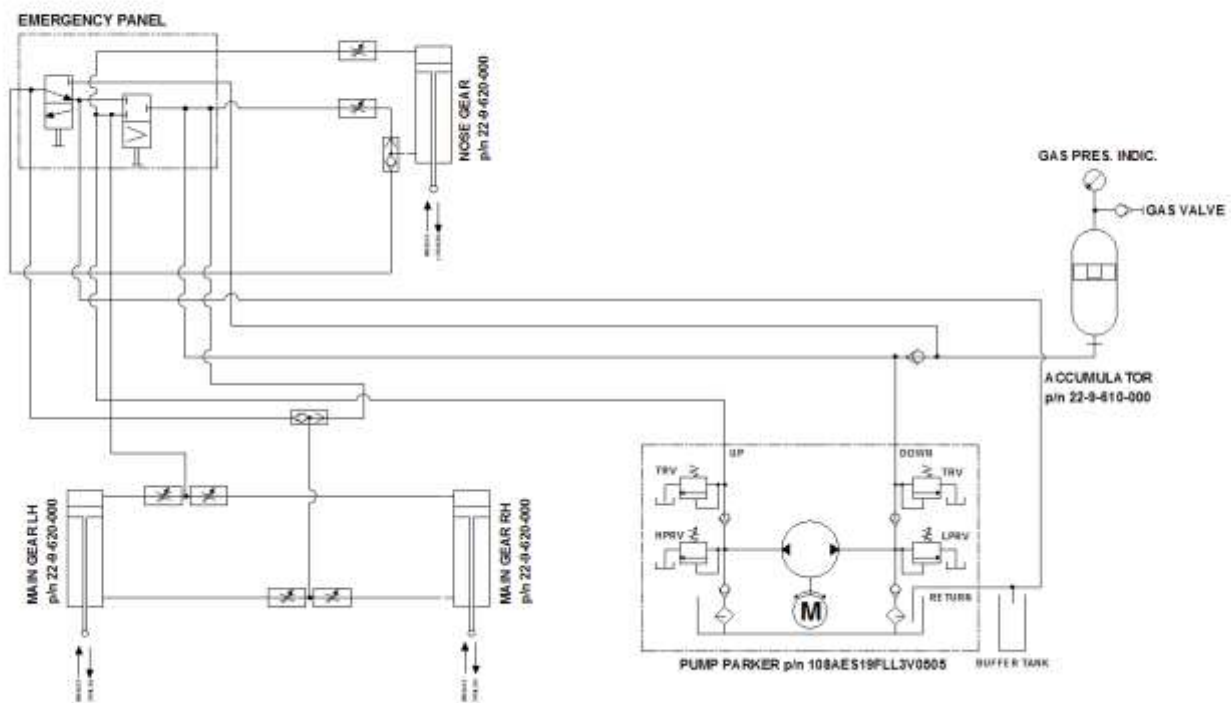

Figure 13. LG hydraulic system schematic

Hydraulic oil, contained in an integrated reservoir located inside the Hydraulic Power Pack, is pressurized by a reversible electric pump: as the LG control knob is placed in either the UP or DOWN position, the pump directs the fluid through the related pressure line toward each hydraulic jack.

In order to prevent an inadvertent LG retraction, the control knob must be pulled before being pushed upward for UP command.

The emergency hydraulic accumulator is used for the landing gear extension: normal extension line and emergency extension line converge in correspondence of the shuttle valves (two valves: the first one for NLG and the second one for MLG emergency operation).

The emergency accumulator nitrogen pressure indicator is located on the tail cone, left side; on ground, a red push-button located beneath the pressure indicator allows the electrical pump for charging the accumulator should the nitrogen pressure be below the lower limit indicated on the placard.

Emergency extension is controlled by two distributors located on the cabin floor, under a removable cover in correspondence of the pilot seat.

The LG indication system is electrical and it is composed by the following main components:

- UP/DN limit micro-switches (6 couples, 2 for each leg)
- leg position lights, 3 green (turned ON when the pertinent leg is extended and locked and located on the LH instrument panel)
- transition light, 1 red (turned ON during transition phases)
- pump light, 1 amber (GEAR PUMP ON caution amber light turned ON when the pump is electrically supplied)
- push to test (for landing gear red and green lights operational check)

The three green lights illuminate only when the respective gear is “down-locked”; the red light indicates the gear is in transit “up” or “down” and the amber caution light GEAR PUMP ON indicates that the pump is electrically supplied.

The red transition light extinguishes only when all the three gear legs are “down-locked” or they are “up” while the amber caution light extinguishes only when the electrical pump is “off”.

The Up/Down limit switches control the LG lights lighting and pump operation on the basis of LG configuration set by the pilot through the LG control knob.

A “push to test” button is used to check that the landing gear position lights are operating.

A warning horn alerts the pilot when the LG control knob is in UP position and at least one of the two throttle levers and/or flaps are respectively set to idle and to LAND position.

During emergency extension, LG position lights work as per normal extension mode: for this reason the LG control knob must be set on DOWN position before starting the emergency procedure.

IMPORTANT

After each emergency landing gear extension, apply the restoration procedure described in the AMM.

INTENTIONALLY LEFT BLANK

10. BRAKES

The A/C is provided with an independent hydraulically actuated brake system for each main wheel. A master cylinder is attached to each pilot/co-pilot's rudder pedal: see schematic below.

Hydraulic pressure, applied via the master cylinders, enters the brake via lines connected to an inlet fitting on the wheel brake caliper.

A parking brake valve, mounted in correspondence of the cabin floor and operated by a knob on the cockpit central pedestal, intercepts the hydraulic lines, once the system is pressurized, to hold the brake assemblies linings tightened round the main wheels brake discs.

Brakes can be operated from both pilot's and co-pilot's pedals: a single vented oil reservoir feeds the pilot side master cylinders which are connected, via hoses, with the co-pilot's side ones.

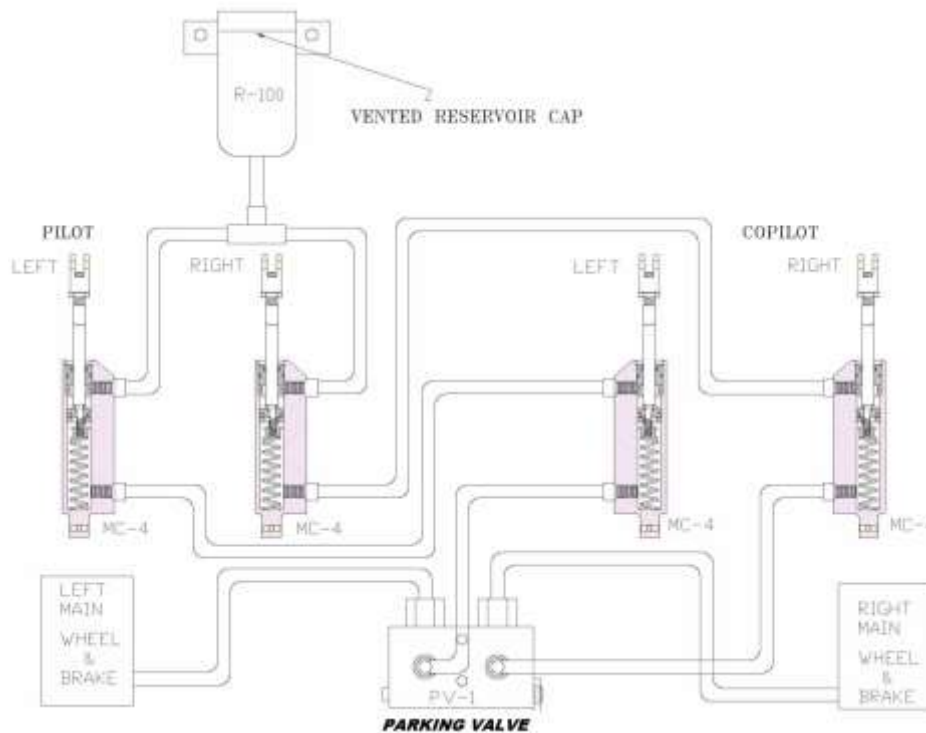

Figure 14. Brake system schematic

NOTE

On the ground, when a pedal is pushed to steer the airplane, do not operate the opposite toe brake until the pedals are back aligned again. This prevents pedals mechanism from being damaged.

11. VENTILATION

If required, pilot allows for ram-air entering the cabin via the two outlet ports respectively located on the left and right side of the instruments panel. Other two ram-air ventilation outlets are located on the cabin head, in the passengers' zone.

12. CABIN HEAT

The cabin heating system utilizes hot air coming from engines heat exchangers: here cold ram-air is warmed by engine exhaust gases and then it is routed to the heating system hoses.

The cabin heat control knobs are positioned on the lower side of the LH instrument panel; when knobs are fully pulled, cabin receives maximum hot air.

Left knob controls the warm air from LH engine heat exchanger, right knob controls the warm air from RH engine heat exchanger.

Crew heating system outlet ports are located on the cabin floor, near the pedestal; for passengers zone it is provided an outlet port on the cabin head.

Windshield defrost is operated via a knob positioned on the pedestal: when knob is pulled the hot air flow for crew heating is deviated to the windshield.

13. SEATS AND SAFETY BELTS

In correspondence of the seats, three fitting points safety belts are provided; belt adjustment is via the sliding buckle located on the belt metal hook.

Seats are built with light alloy tube structure and synthetic material cushioning. It is possible to perform following seat adjustments:

Horizontal – pulling the lower front lever and sliding the seat

Vertical – operating the lever located on the outward seat side

Seat back inclination – unlocking it via the lateral knob

These adjustments ensure the crew and passengers comfort.

14. DOORS

The cabin main door is located forward, on the left side of the fuselage while the emergency exit (passenger door) is located aft, on the right side of the fuselage.

On the top of the cabin it is located the ditching emergency exit: see figure below.

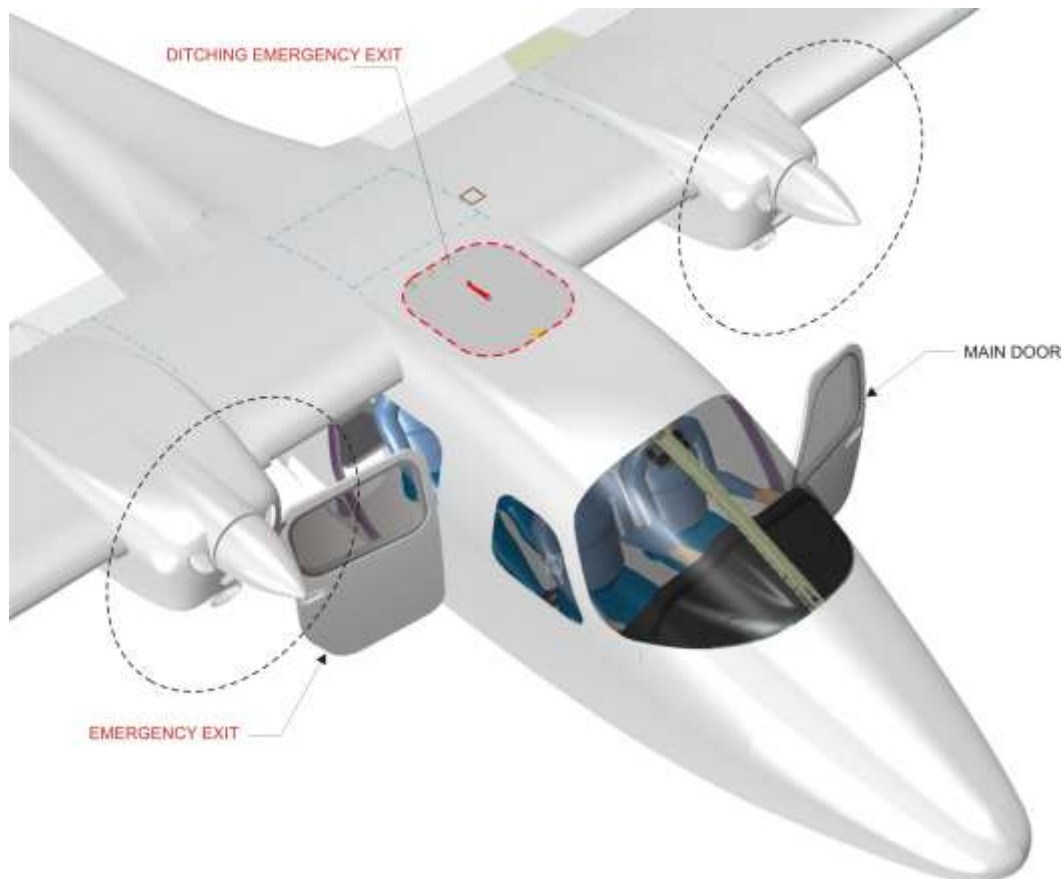

Figure 15. Doors location

Being the main door located in correspondence of the propeller disc, its operation is limited to the engine shut-down condition.

In fact, in order to prevent crew injuries, an electro-mechanical device locks the door latch when left engine runs. A pressure switch senses engine oil pressure and allows for electrical supply to a solenoid which engages the door lock mechanism.

This prevents the latch opening when left engine runs but, if needed, the device can be also manually by-passed operating either from the door inside panel or

from outside. Instructions are reported on the placards near the by-pass lever, located in correspondence of the latch: to unlock it is necessary to push and hold the red tab down, after that the door can be opened operating the handle.

After engine shut-down, the pressure drop can have a certain delay, preventing the door from being opened by normal means: do not force the handle but operate the override system above mentioned.

In any case, the electric lock becomes disengaged after a complete loss of the electric power.

Two switches engage respectively when the door and the latch are closed. Should one or both switches be released, the MAIN DOOR OPEN warning light is turned ON.

The emergency exit is fitted with the same safety device: in this case the pressure switch allowing for solenoid operation is activated from right engine oil pressure line; should be the door “open” or “closed and unlocked”, the REAR DOOR OPEN warning light is turned ON.

Any voluntary operation of the manual by-pass solenoid lock causes related door warning light is turned on.

The ditching emergency exit is manually operated turning the handle and pushing outward the door.

The yellow fluorescent painted handle, which can be operated also from outside, is fitted with a safety wire assuring removal effortless. When the door is open, it stays connected to the fuselage by means of two cables which allow for door opening forward.

15. BAGGAGE COMPARTMENT

The baggage compartment is located behind the passengers’ seats. The baggage must be uniformly distributed on the floor and the weight cannot overcome 80kg. Make sure that the baggage is secured before the flight.

INTENTIONALLY LEFT BLANK





INTENTIONALLY LEFT BLANK





16. PLACARDS







In addition to the limitation placards reported on Section 2, following placards are installed on the aircraft.

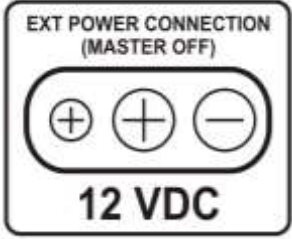

NOTE

Additionally, nearby the placards listed below (English language), directly-translated placards in the language of the country in which the airplane is registered can be installed, when required by the specific NAA.

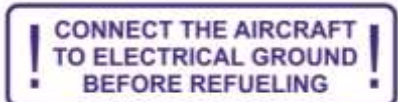
Description	Placard	Place
ELT equipment location		Baggage compartment, right side
First Aid Kit location		Baggage compartment, aft cover panel
Fire extinguisher location		Cockpit floor, pilot side
Emergency gear extension compartment location		Removable cap

Description	Placard	Place
Emergency gear extension instructions		Emergency distributors compartment
Alternate static port location		Central pedestal, left side
Alternate static port operating instructions		Central pedestal, right side
Static ports location	<p style="text-align: center;">STATIC PORT KEEP CLEAN</p>	Static ports: fuselage - both sides
Battery compartment location		Fuselage tail, left side
EXT power connection: socket schematic and instructions		Fuselage tail, left side

Description	Placard	Place
Landing gear hydraulic accumulator: low pressure limit		LG hydraulic compartment cap (fuselage tail, left side)
LG hydraulic compartment location		Fuselage tail, left side, in correspondence of LG hydraulic compartment cap
Towing limitations		Nose LG forward door
Stabilator excursion range		Fuselage tail, left side, in correspondence of the stabilator leading edge
Aircraft grounding		Close to the fuel filler cap
Engine coolant expansion tank location		Engine nacelle top side

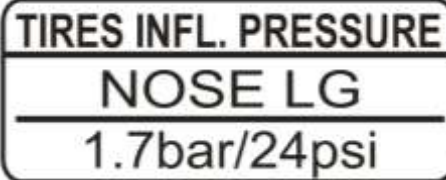
Description	Placard	Place
Steel boards: a/c identifica- tion marks	 <p style="text-align: center;">(Sample)</p>	Fuselage tail, left side
Main LG tires inflation pres- sure values		MLG leg, LH and RH
Nose LG tire inflation pres- sure values		Nose LG fork

INTENTIONALLY LEFT BLANK

INTENTIONALLY LEFT BLANK

17. INSTRUMENTS PANEL

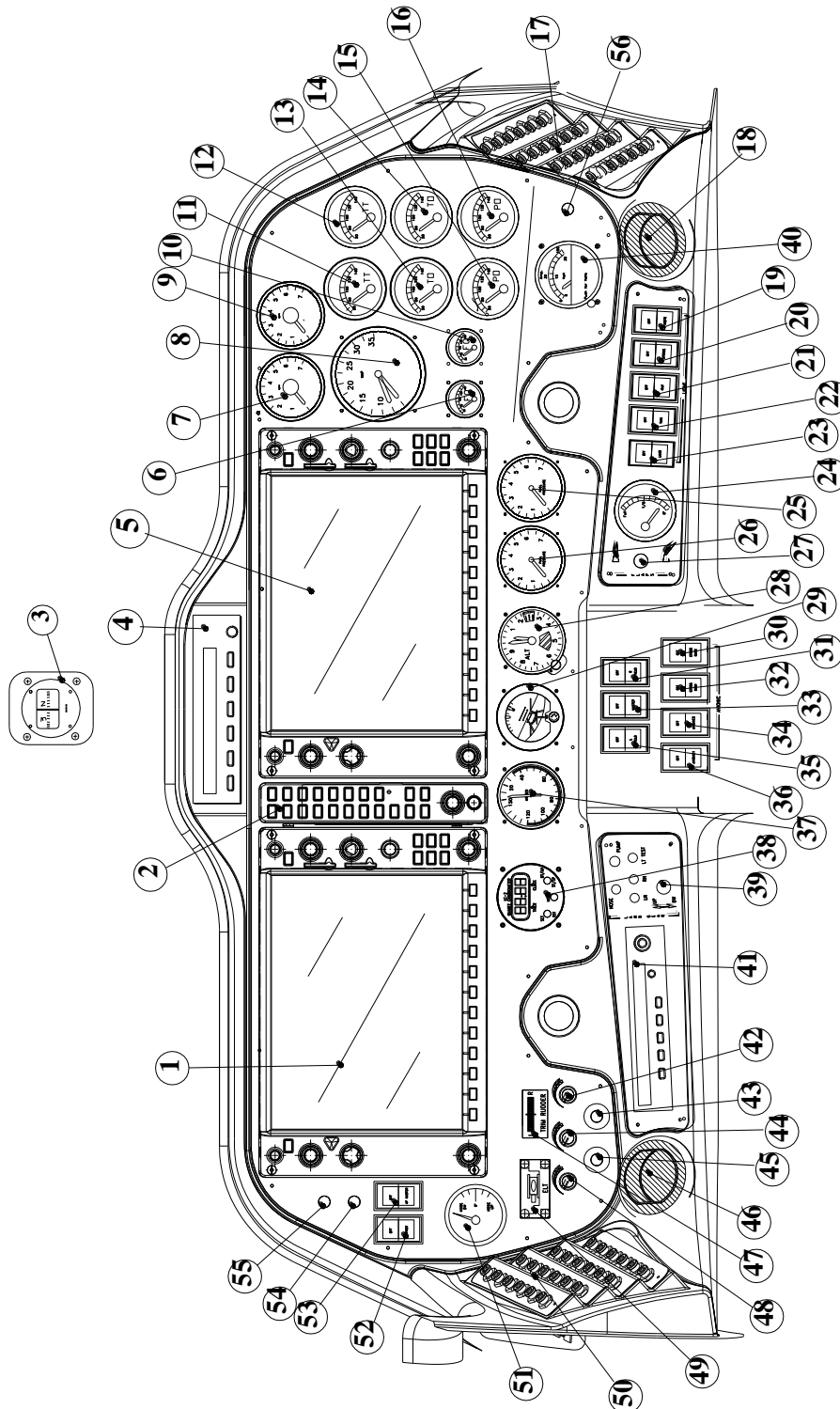

GARMIN G950 IFDS - Instruments panel (typical layout)

Item	Description
1	GDU 1040 (PFD)
2	GMA 1347
3	Compass
4	A/P Programmer/Computer
5	GDU 1040 (MFD)
6	LH fuel quantity indicator
7	LH R.P.M.
8	Dual M.A.P. indicator
9	RH R.P.M.
10	RH fuel quantity indicator
11	LH CHT
12	RH CHT
13	LH Oil Temperature
14	RH Oil Temperature
15	LH oil pressure
16	RH oil pressure
17	RH breakers panel
18	RH ram air inlet
19	Instruments light switch
20	Strobe light switch
21	Navigation light switch
22	Taxi light switch
23	Landing light switch
24	Position flaps indicator
25	RH fuel pressure
26	LH fuel pressure
27	Flap switch
28	Standby Altimeter
29	Standby Attitude indicator
30	RH Cross bus switch

Item	Description
31	RH Field
32	LH Cross bus switch
33	Master switch
34	RH Avionic switch
35	LH Field
36	LH Avionic switch
37	Standby Airspeed indicator
38	Chronometer
39	LG control knob
40	Voltammeter Indicator
41	ADF control panel
42	Cockpit light dimmer
43	Cabin heat (warm air from RH engine)
44	Avionics lights dimmer
45	Cabin heat (warm air from LH engine)
46	LH ram air inlet
47	Trim rudder indicator
48	Switches built-in lights dimmer
49	ELT Indicator
50	RH breakers panel
51	Pitch trim indicator
52	Pitot heat switch
53	A/P Master switch
54	A/P trim master switch
55	Fire Detector push-to-test
56	LH/RH Ammeter selector switch

INTENTIONALLY LEFT BLANK

18. ELECTRICAL SYSTEM

Primary DC power is provided by two engine-driven generators which, during normal operations, operate in parallel.

Each generator is rated at 14,2-14,8 Vdc, 40 Amp, and it is fitted with an integrated regulator, which acts to maintain a constant output voltage, and with an automatic overvoltage device protecting the circuits and the electric components from an excessive voltage caused by generator failures.

The power rating of the each generator is such that if one generator fails the other one can still supply the airplane equipment to maintain flight safety.

Secondary DC power is provided by a battery (lead type - Gill Teledyne G35, 12 V, 38-Ah in 20h run time) and an external DC power source can be connected to the aircraft DC distribution system.

On the instruments panel, right side, it is installed a voltmeter/ammeter. The ammeter section can indicate the current supplied by either left or right generator switching a dedicated selector.

There are five different busses (make reference to Figure 11):

- Battery bus
- LH Generator bus
- RH Generator bus
- LH Avionics bus
- RH Avionics bus

The distribution system operates as a single bus with power being supplied by the battery and both generators but it is possible to separate the left busses from the right busses when required by means of the Cross Bus switches.

All electrical loads are divided among the five busses on the basis of their importance and required power: equipment with duplicate functions is connected to separate busses.

The Battery bus, which supplies the most important loads, is energized from three sources: the battery and both generators. This allows the bus for remaining active also in case of two independent faults in the supply paths.

The following loads are connected to the battery bus:

Battery Bus
GMA 1347 Audio Panel
GIA #1
GDU PFD
Cooling Fan
Converter 1
Standby attitude indicator
LH and RH Fuel electrical pump
LH and RH Fuel pressure
LH and RH Fuel quantity
LH and RH Oil pressure
LH and RH Oil temperature
LH and RH CHT
LH and RH RPM indicator
Cabin lights
Cockpit lights
Switches built-in lights
Avionics lights
Strobe lights
Flaps
Doors pressure switches
Engine hour meter (2 units)
Turn coordinator (A/P slaved)
LG hydraulic pump
LG indicating & control system
LH and RH Fire detector
Chronometer
12V cabin electrical power sockets (2 units)

In addition, directly on the battery, the following devices are connected:

- Emergency back-up attitude indicator (RH attitude indicator – usually supplied from RH generator bus), when installed;
- Emergency Light
- Chronometer

The first two devices are controlled by the pertinent switches located on the LH breakers rack.

The other loads are so divided among following busses:

LH GEN Bus	LH Avionic Bus
Pitot heat	DME
Landing light	Transponder
Taxi light	Encoder altimeter

RH GEN Bus	RH Avionic Bus
NAV lights	ADF
Rudder trim	COM 2
Stall warning	NAV 2
RH attitude indicator	A/P (*)
	A/P Pitch Trim (*)

(*) if installed

On the central pedestal (see Figure below) there are seven switches disposed on two rows: on the first row there is the MASTER SWITCH which allows for connecting, through the battery relay, the battery to the battery bus.

LH and RH FIELD switches control the pertinent generator: setting the switch to OFF puts the pertinent generator off-line.

In correspondence of the second row there are 4 switches LH/RH AVIONIC and LH/ RH CROSS BUS.



Central pedestal switches console

The first two allow, through a relay, for cutting off the power supply to the pertinent avionic bus.

The second ones allow, through a relay, for realizing the parallel connection between the pertinent generator bus and the battery bus. Setting these ones to OFF,

the pertinent generator bus (and related avionic bus supplied) is separated from the battery bus and from opposite generator bus.

When both generators are correctly operating and all above mentioned switches are in ON position, all the busses are connected to the generators.

The ignition switches, two for each engine and grouped on the over head panel, are instead independent from the airplane electrical system (generation and distribution); they only control and open the engine electrical circuit.



If ignition switches are turned ON, a propeller movement can cause the engine starting with consequent hazard for people nearby.

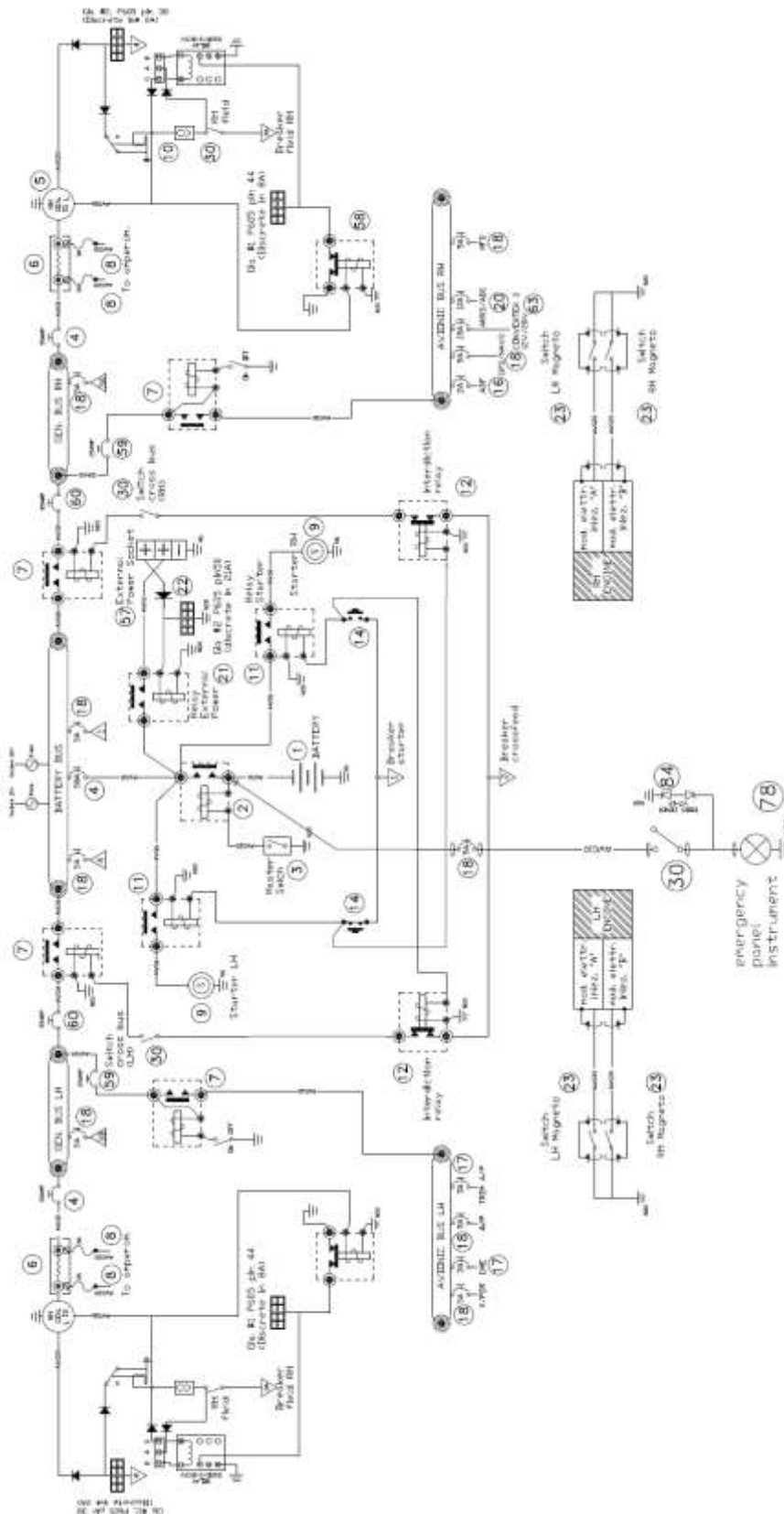

Electric system schematic

INTENTIONALLY LEFT BLANK

SECTION 8 – AIRCRAFT CARE and MAINTENANCE**INDEX**

1. Introduction	3
2. Inspection intervals.....	3
3. Aircraft changes or repairs	3
4. Maintenance	4
4.1. Refuelling.....	4
4.2. Oil level control	4
4.3. Landing gear tires pressure control	5
5. Ground towing, parking and mooring.....	6
5.1. Towing	6
5.2. Parking.....	6
5.3. Mooring	7
6. Cleaning.....	8
6.1. Windows.....	8
6.2. External surfaces	8
6.1 Propeller.....	8
6.2 Engine	8
6.3 Internal surfaces	9
7. Ice removal.....	9

INTENTIONALLY LEFT BLANK

1. INTRODUCTION

This Section deals with main care and maintenance operations for *P2006T*.

Refer to Aircraft Maintenance Manual to establish the controls / inspections / maintenance tasks (scheduled and unscheduled) to be performed.

2. INSPECTION INTERVALS

Scheduled inspections must be performed in accordance with the instructions addressed on the Aircraft Maintenance Manual. Independently from the aircraft flight hours, an annual inspection has to be performed.

The first scheduled engine inspection must be carried out after first 3/6 hours. All required inspections are reported in the Aircraft Maintenance Manual.

As far as the scheduled/unscheduled engine maintenance is concerned, refer to the engine manufacturer Maintenance Manual.

Unscheduled inspections/maintenance tasks are necessary when one or more of following conditions occur:



CAUTION

1. *Emergency landing*
2. *Breaking / damage of propeller (or in case of simple impact)*
3. *Engine fire*
4. *Lights damage*
5. *Any type of damage or failure*

3. AIRCRAFT CHANGES OR REPAIRS

Aircraft changes or repairs must be performed in accordance with Aircraft Maintenance Manual and only by TECNAM authorized personnel.

4. MAINTENANCE

4.1. REFUELLING

- *Do not perform aircraft refuelling near flames, sparks or similar.*
- *Avoid fuel contact with the skin: a skin corrosion could occur.*
- *Make sure that a fire extinguisher is available nearby during refuelling operations.*



- *Make sure that overall aircraft instrumentation is turned OFF before performing the refuelling.*
- *Do not operate switches and/or pushbuttons inside the aircraft during refuelling operation; make sure that crew left the aircraft before performing refuelling.*
- *Make sure that the aircraft is electrically connected to the ground.*

4.2. OIL LEVEL CONTROL

1. Open the inspection cap on the engine nacelle
 2. Prior to oil check, switch off both ignitions circuits and turn the propeller by hand in direction of engine rotation several times to pump oil from the engine into the oil tank, or let the engine idle for 1 minute. This process is finished when air is returning back to the oil tank and can be noticed by a murmur from the open oil tank.
 3. Clean the dipstick and soak it in the reservoir
 4. Remove dipstick and read oil level
 5. If required, replenish oil: oil level should be between max. and min. mark of the oil level dipstick
1. Close the inspection cap
 2. Repeat the procedure for the other engine

4.3. LANDING GEAR TIRES PRESSURE CONTROL

1. Remove wheel dust cover (on main LG wheels)
2. Unscrew the tire cap
3. Connect a gauge
4. Read the pressure value
5. If required, rectify the pressure (nose tire 1.7 Bar / 24 Psi, main landing gear tires 2,3 Bar / 33 Psi)
6. Fit the tire cap
7. Install wheel dust cover (on main LG wheels)

5. GROUND TOWING, PARKING AND MOORING

5.1. TOWING



CAUTION

When the a/c is moved on the ground, either manually or by towing, the Master Switch must be turned ON until the a/c is parked.

To tow the aircraft it is necessary to use a metal stiff bar connected to the nose gear.



WARNING

Do not turn nose wheel above 20° either side of center: greater steering angles can damage the wheel stop. The tow bar must be removed before engines starting.

5.2. PARKING

General

Under normal weather conditions, the airplane may be parked and headed in a direction that will facilitate servicing without regard to prevailing winds. Ensure that it is sufficiently protected against adverse weather conditions and present no danger to other aircraft.

Procedure

1. Position airplane on levelled surface, headed into the prevailing wind, if practical.
2. Engage parking brake
3. Install control locks
4. Secure pilot control wheel by wrapping the seat belt around it

NOTE:

Do not engage the parking brakes at low ambient temperature, when an accumulation of moisture may cause the brakes to freeze, or when they become hot from severe use. In this case use wheel chocks.

In case of long time parking or overnight parking, it is recommended to moor the a/c as shown on Para. 5.3.



CAUTION

Mooring is strongly recommended when the wind is more than 15 knots and the a/c is completely refuelled.

5.3. MOORING

The aircraft is moored to insure its immovability, protection, and security under various weather conditions.



CAUTION

Mooring is strongly recommended when the wind is more than 15 knots and the a/c is completely refuelled.

Procedure

1. Position airplane on levelled surface and headed into the prevailing wind, if practical
2. Center nose wheel and engage parking brake and/or use the wheel chocks

NOTE:

Do not engage the parking brakes at low ambient temperature, when an accumulation of moisture may cause the brakes to freeze, or when they become hot from severe use. In these cases use wheel chocks.

3. Secure pilot control wheel by wrapping the seat belt around it
4. Assure that flaps are retracted
5. Electrically ground airplane, by connecting ground cable to the engine muffle
6. Install control locks
7. Install protective plugs
8. Close and lock cabin doors.
9. Secure tie-down cables to the nose gear leg (in correspondence of the wheel fork) and to the wings and tail cone tie-down rings at approximately 45 degree with respect to the ground. (Refer to following figures)

NOTE:

Additional preparation for high winds includes tie-down ropes from the main landing gear forks employment.

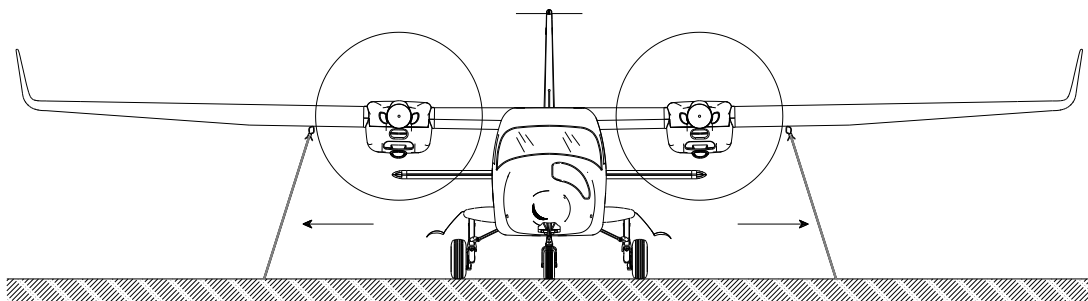

Mooring – front view

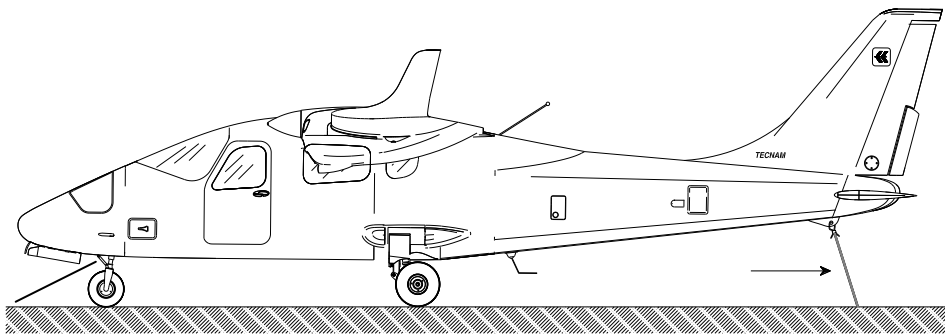

Mooring – side view

6. CLEANING



CAUTION

Aircraft surface must be kept clean to ensure expected flight performance. Excessively dirty surfaces can affect normal flight conditions.

6.1. WINDOWS

For windows cleaning, it is allowed the use of acrylic products employed for glass and Plexiglas surfaces cleaning.

6.2. EXTERNAL SURFACES

Aircraft surface is cleaned with soapy water; they are not allowed solvents or alcohol based products. Died insects must be removed using hot water. It is advisable to avoid outside aircraft parking for long periods; it is always convenient to keep the aircraft in the hangar.

6.1 PROPELLER

To preserve its functionality avoiding wear and corrosion, the propeller manufacturer uses, for external surface painting, an acrylic paint which is resistant to all solvents. In any case it is advisable to clean the propeller using exclusively soapy water.

6.2 ENGINE

Engine cleaning is part of the scheduled maintenance. Refer to the engine manufacturer Maintenance Manual for operating and for planning its cleaning.

6.3 INTERNAL SURFACES

Interiors must be cleaned with a rate of 3 to 6 months. Any object present in the cabin (like pens, lost property, maps etc) must be removed.

The instrumentation as a whole must be cleaned with a humid cloth; plastic surfaces can be cleaned with suitable products.

For parts not easily accessible, perform cleaning with a small brush; seats must be cleaned with a humid cloth.

7. ICE REMOVAL

Anti icing products are not allowed. To remove ice, tow the aircraft in the hangar and operate with a soft brush or a humid cloth.

INTENTIONALLY LEFT BLANK

SECTION 9 – SUPPLEMENTS

INDEX

1. Introduction.....	3
2. Supplements lists.....	4

SUPPLEMENTS LIST FOR AIRPLANES WITH ANALOGUE INSTRUMENTS

- Supplement no. A1 - Garmin GNS-430W GPS/WAAS COMM/NAV**
- Supplement no. A2 - Garmin SL30 VHF COMM/NAV**
- Supplement no. A3 - Garmin GMA340 audio panel**
- Supplement no. A4 - Garmin GTX328 Mode S transponder**
- Supplement no. A5 - KR 87 ADF System**
- Supplement no. A6 - KN 63 DME System**
- Supplement no. A7 - KCS 55A Compass System**
- Supplement no. A8 - Garmin GNS-530W GPS/WAAS COMM/NAV**
- Supplement no. A9 - Garmin GTX330 Mode S transponder**
- Supplement no. A10 - Garmin GMA347 audio panel**
- Supplement no. A11 - Becker BXP 6401-2-(01) Mode S transponder**
- Supplement no. A12 - S-TEC Fifty Five X Autopilot**
- Supplement no. A13B - GTN 650 equipment**
- Supplement no. A14 - Engine starting battery**
- Supplement no. A15 - Power supply from built-in generators**
- Supplement no. A16 - AFM supplement for CIS operators**
- Supplement no. A17 - Brazilian AFMS**
- Supplement no. A18 - Chinese AFMS**
- Supplement no. A19 - Increased MTOW - 1230 KG (MOD 2006/015)**
- Supplement no. A20 - Increased V_{le}/V_{lo}**
- Supplement no. A21 - South African AFM**
- Supplement no. A22 - Argentine AFM**
- Supplement no. A23 - Ukrainian AFM**
- Supplement no. A24 - SMP for Analogic Configuration**
- Supplement no. A25 - Alternators with 70A**
- Supplement no. A26 - India AFMS**
- Supplement no. A27 - Oil Temp. indicator update**

SUPPLEMENTS LIST FOR AIRPLANES WITH GARMIN G950 IFDS

- Supplement no. G1 – Garmin G950 IFDS**
- Supplement no. G2 – S-TEC Fifty Five X Autopilot for GARMIN G950**
- Supplement no. G3 – KR 87 ADF System for GARMIN G950**
- Supplement no. G4 – KN 63 DME System for GARMIN G950**
- Supplement no. G5 – Engine starting battery**
- Supplement no. G6 – Power supply from built-in generators**
- Supplement no. G7 – AFM supplement for CIS operators**
- Supplement no. G8 – Brazilian AFMS**
- Supplement no. G9 – Chinese AFMS**
- Supplement no. G10 – Increased MTOW - 1230 KG (MOD 2006/015)**
- Supplement no. G11 – Increased V_{le}/V_{lo}**
- Supplement no. G12 – South African AFM**
- Supplement no. G13 – Alternators with 70A**
- Supplement no. G14 – SMP for Digital Configuration**
- Supplement no. G15 – RESERVED**
- Supplement no. G16 – MD302 Alternative Stand-By Instrument**
- Supplement no. G17 – Stormscope**
- Supplement no. G18 – Oil Temp. indicator update**

1. INTRODUCTION

This Section concerns the supplemental manuals of additional (or optional) instrumentation equipping the *P2006T*.

Two lists are reported: the first one applies to airplanes with analogue instruments, the second one applies to airplanes embodying the Design Change MOD2006/002 “Garmin G950”.

2. SUPPLEMENTS LISTS

Aircraft S/N:		Registration marks:		Date:	
SUPPLEMENTS LIST FOR AIRPLANES WITH ANALOGUE INSTRUMENTS					
Sup. No.	Title	Rev. no.	Date	APPLICABLE:	
				YES	NO
A1	Garmin GNS-430W Gps/VHF Comm/Nav			<input type="checkbox"/>	<input type="checkbox"/>
A2	Garmin SL30 VHF Comm/Nav			<input type="checkbox"/>	<input type="checkbox"/>
A3	Garmin GMA 340 Audio Panel			<input type="checkbox"/>	<input type="checkbox"/>
A4	Garmin GTX 328 Mode S Transponder			<input type="checkbox"/>	<input type="checkbox"/>
A5	Bendix-King Honeywell KR 87 ADF System			<input type="checkbox"/>	<input type="checkbox"/>
A6	Bendix-King Honeywell KN 63 DME System			<input type="checkbox"/>	<input type="checkbox"/>
A7	KCS 55A Compass System			<input type="checkbox"/>	<input type="checkbox"/>
A8	Garmin GNS-530W Gps/VHF Comm/Nav			<input type="checkbox"/>	<input type="checkbox"/>
A9	Garmin GTX 330 Mode S Transponder			<input type="checkbox"/>	<input type="checkbox"/>
A10	Garmin GMA 347 Audio Panel			<input type="checkbox"/>	<input type="checkbox"/>
A11	Becker BXP 6401-2-(01) Mode S transponder			<input type="checkbox"/>	<input type="checkbox"/>
A12	S-TEC Fifty Five X Auto- pilot			<input type="checkbox"/>	<input type="checkbox"/>
A13B	GTN 650 equipment			<input type="checkbox"/>	<input type="checkbox"/>
A14	Engine starting battery			<input type="checkbox"/>	<input type="checkbox"/>
A15	Power supply from built- in generators			<input type="checkbox"/>	<input type="checkbox"/>
A16	AFM Supplement for CIS countries operators			<input type="checkbox"/>	<input type="checkbox"/>
A17	Brazilian AFMS			<input type="checkbox"/>	<input type="checkbox"/>

Aircraft S/N:		Registration marks:		Date:	
SUPPLEMENTS LIST FOR AIRPLANES WITH ANALOGUE INSTRUMENTS					
Sup. No.	Title	Rev. no.	Date	APPLICABLE:	
				YES	NO
A18	Chinese AFMS			<input type="checkbox"/>	<input type="checkbox"/>
A19	Increased MTOW - 1230 KG (MOD 2006/015)			<input type="checkbox"/>	<input type="checkbox"/>
A20	Increased Vle/Vlo			<input type="checkbox"/>	<input type="checkbox"/>
A21	South African AFM			<input type="checkbox"/>	<input type="checkbox"/>
A22	Argentine AFM			<input type="checkbox"/>	<input type="checkbox"/>
A23	Ukrainian AFM			<input type="checkbox"/>	<input type="checkbox"/>
A24	SMP for Analogic Configuration			<input type="checkbox"/>	<input type="checkbox"/>
A25	Alternators with 70A			<input type="checkbox"/>	<input type="checkbox"/>
A26	India AFMS			<input type="checkbox"/>	<input type="checkbox"/>
A27	Oil Temp. indicator update			<input type="checkbox"/>	<input type="checkbox"/>

INTENTIONALLY LEFT BLANK

Aircraft S/N:		Registration marks:		Date:	
SUPPLEMENTS LIST FOR AIRPLANES WITH GARMIN G950 IFDS					
Sup. No.	Title	Rev. no.	Date	APPLICABLE:	
				YES	NO
G1	Garmin G950 IFDS			<input type="checkbox"/>	<input type="checkbox"/>
G2	S-TEC Fifty Five X Auto-pilot for GARMIN G950			<input type="checkbox"/>	<input type="checkbox"/>
G3	Bendix-King Honeywell KR 87 ADF System for GARMIN G950			<input type="checkbox"/>	<input type="checkbox"/>
G4	Bendix-King Honeywell KN 63 DME System for GARMIN G950			<input type="checkbox"/>	<input type="checkbox"/>
G5	Engine starting battery			<input type="checkbox"/>	<input type="checkbox"/>
G6	Power supply from built-in generators			<input type="checkbox"/>	<input type="checkbox"/>
G7	AFM Supplement for CIS countries operators			<input type="checkbox"/>	<input type="checkbox"/>
G8	Brazilian AFMS			<input type="checkbox"/>	<input type="checkbox"/>
G9	Chinese AFMS			<input type="checkbox"/>	<input type="checkbox"/>
G10	Increased MTOW - 1230 KG (MOD 2006/015)			<input type="checkbox"/>	<input type="checkbox"/>
G11	Increased Vle/Vlo			<input type="checkbox"/>	<input type="checkbox"/>
G12	South African AFM			<input type="checkbox"/>	<input type="checkbox"/>
G13	Alternators with 70A			<input type="checkbox"/>	<input type="checkbox"/>
G14	SMP for Digital Configuration			<input type="checkbox"/>	<input type="checkbox"/>
G15	- Reserved -			<input type="checkbox"/>	<input type="checkbox"/>
G16	MD302 Alternative Stand-By Instrument			<input type="checkbox"/>	<input type="checkbox"/>
G17	Stormscope			<input type="checkbox"/>	<input type="checkbox"/>
G18	Oil Temp. indicator update			<input type="checkbox"/>	<input type="checkbox"/>

INTENTIONALLY LEFT BLANK

SUPPLEMENT NO. A22 – ARGENTINE AFM
Record of Revisions

Rev	Revised page	Description of Revision	Tecnam Approval			EASA Approval Or Under DOA Privileges
			DO	OoA	HDO	
0	--	First issue	D. Ronca	G.Paduano	M. Oliva	See Note (*)

Note (*): this Supplement has been originally issued on 5th May 2014, after EASA Third Country Validation process completion.

LOEP

Page	Revision	Page	Revision
A22-1	Rev 0	A22-10	Rev 0
A22-2	Rev 0	A22-11	Rev 0
A22-3	Rev 0	A22-12	Rev 0
A22-4	Rev 0		
A22-5	Rev 0		
A22-6	Rev 0		
A22-7	Rev 0		
A22-8	Rev 0		
A22-9	Rev 0		

TABLE OF CONTENTS

INTRODUCTION..... 4
General..... 5
1. Fuel 5
Limitations 5
1. Kind of Operation Equipment 5
2. Other Placards 6

INTRODUCTION

This Supplement applies for Argentine registered aircraft.

It contains supplemental information to the basic information approved in EASA aircraft Flight Manual when the aircraft is registered in Argentina.

For Limitations, procedures, and performance information not contained in this supplement, refer to the basic Aircraft Flight Manual.

The information contained herein supplements or supersedes the basic Aircraft Flight Manual, as applicable.

GENERAL**1. FUEL**

Approved fuel:





MOGAS ASTM D4814





AVGAS 100LL (ASTM D910)







LIMITATIONS**1. KIND OF OPERATION EQUIPMENT**





The equipment appropriate for different types of operations must comply with applicable regulations.



2. OTHER PLACARDS

Description	Placard	Place	Dimensions (mm)
ELT equipment location		Baggage compartment, right side	50x45
First Aid Kit location		Baggage compartment, aft cover panel	40x40
Fire extinguisher location		Cockpit floor, pilot side	35x50
Emergency gear extension compartment location		Removable cap	55x28
Emergency gear extension compartment location (only if MOD2006/33 or SB 098 CS is installed)		Removable cap	55x28

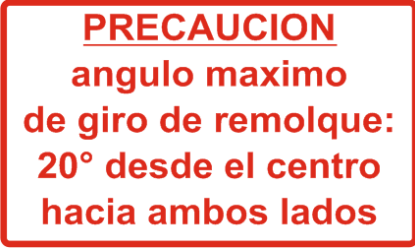
Description	Placard	Place	Dimensions (mm)
Emergency gear extension instructions		Emergency distributors compartment	55x28
Smoking ban		Instruments panel, right side	21x3
ESB voltmeter (see suppl. A14)		Instruments panel, right side	56x9
Battery housing		On the battery housing, left side, aircraft tail cone	65x40
Engine oil level and specifications		On the engine nacelle, in correspondence of the engine oil reservoir access door	50x50

Description	Placard	Place	Dimensions (mm)
Fuel type and quantity		In correspond- ence of each fuel tank filler cap.	70x50
Ground con- nection during refuelling pro- cedure		In correspon- dance of each tank filler cap	85x20
Baggage com- partment ca- pacity		Baggage com- partment (ver- tical panel)	90x55
Ditching emer- gency exit: opening in- structions	 	Ditching emer- gency exit handle: internal side	77x46 - Ø200
Ditching emer- gency exit: opening in- structions	 	Ditching emer- gency exit handle: exter- nal side	77x46 - Ø200

Description	Placard	Place	Dimensions (mm)
Door locking system: bypass instructions		Main door and emergency exit: internal side	55x30 each
Door locking system: bypass instructions		Main door and emergency exit: external side	55x30 each
Main door: exit instructions		Main door, internal side	67x20
Emergency exit label	<p style="text-align: center; color: red; font-weight: bold; font-size: 1.5em;">EMERGENCY EXIT SALIDA DE EMERGENCIA</p>	Emergency exit: internal and external side	200x20
Towing maximum turning angle		Nose landing gear front door	88x52
Seat position advisory		Behind pilot and co-pilot seats	85x18

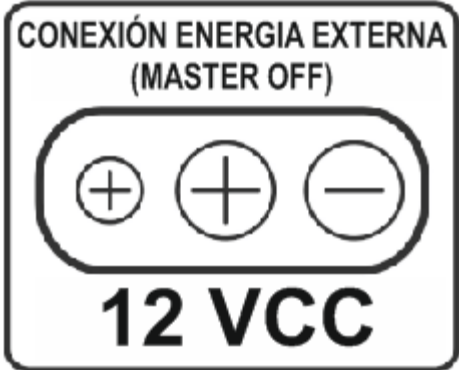
Description	Placard	Place	Dimensions (mm)
Coolant tank content		On the coolant tank	17x19
Main gear tires inflating pressure		Near each main gear wheel	47x20
Nose gear tires inflating pressure		Near the nose wheel	47x20
External power socket		Below the external power socket, aircraft tail cone, left side	50x48
Emergency tank max pressure indicating	PRESION TANQUE LIQUIDO HIDRAULICO DE EMERGENCIA LIMITE DE BAJA PRESION 20 BAR / 290 P.S.I.	On the emergency tank inspection door, left side, aircraft tail cone	150x15
Static port	TOMA ESTATICA MANTENER LIMPIA	On each static port, left and right side of aircraft tail cone	40x12

Description	Placard	Place	Dimensions (mm)
LG hydraulic compartment location	TREN DE ATERRIZAJE COMPARTIMIENTO HIDRAULICO	Fuselage tail, left side, in correspondence of LG hydraulic compartment cap	80x20

INTENTIONALLY LEFT BLANK

Supplement no. A23

Ukrainian Aircraft Flight Manual Supplement

Record of Revisions

Rev	Revised page	Description of Revision	Tecnam Approval			EASA Approval or Under DOA Privileges
			DO	OoA	HDO	
0	-	See Note (*)	D. Ronca	M. Oliva	M. Oliva	DOA

Note (*): this Supplement has been originally issued on 12 January 2015, after EASA Third Country Validation process completion.

List of Effective Pages

Page	Revision	Page	Revision
A23-1	Rev 0		
A23-2	Rev 0		
A23-3	Rev 0		
A23-4	Rev 0		
A23-5	Rev 0		
A23-6	Rev 0		
A23-7	Rev 0		
A23-8	Rev 0		
A23-9	Rev 0		
A23-10	Rev 0		
A23-11	Rev 0		
A23-12	Rev 0		

TABLE OF CONTENTS

INTRODUCTION	3
GENERAL.....	3
FUEL.....	3
LIMITATIONS	4
Flight Altitude	4
Types of surface.....	4
Restriction flight area without HF COMM	4
Other placards	4
Kinds of Operations Equipment List.....	5
EMERGENCY PROCEDURES	6
Smoke and fire occurrence	6
NORMAL OPERATIONS	7
PERFORMANCES	8
Landing performances.....	8
WEIGHT AND BALANCE.....	10

INTRODUCTION

This supplement must be placed in EASA Approved P2006T Aircraft Flight Manual Section 9, if the airplane is delivered in Ukraine.

This supplement must be applied to both P2006T digital and analogue configuration.

For limitations, procedures, and performance information not contained in this supplement, refer to the EASA Approved Aircraft Flight Manual.

GENERAL

The information contained herein complements or supersedes the basic information in the EASA Approved Aircraft Flight Manual.

FUEL

APPROVED FUEL

- MOGAS ASTM D4814
- MOGAS EN 228 Super/Super plus (min. RON 95)
- AVGAS 100 LL (ASTM D910)
- MOGAS DSTU 4839-2007

LIMITATIONS

FLIGHT ALTITUDE

“For flight at altitudes above 3600 m (11811 ft) the crew must use oxygen equipment.

Flights between 3000m (9842 ft) and 3600 (11811) altitude without oxygen equipment for the crew are limited to a maximum of 30 minutes.

For airplane operation above 3000 m (9842 ft) for more than 30 minutes, Oxygen supply must be provided for at least one passenger.”

TYPES OF SURFACE

Take-off and landing operations must be conducted on dry or wet paved surfaces, dry or grass surfaces with a maximum grass height of 10 centimeters, or unpaved runways with a soil strength greater than or equal to 6 kg per sq. centimeter ($\sigma \geq 6 \text{ kg/cm}^2$).

RESTRICTION FLIGHT AREA WITHOUT HF COMM

The flights of the airplane that are not equipped with HF communication system in areas without VHF communication capabilities are prohibited.

OTHER PLACARDS

Description	Placard	Place
Fuel type and quantity	 <p>MOGAS ASTM D4814-EN 228 SUPER/SUPER PLUS (min. RON 95) DSTU 4839-2007</p> <p>AVGAS 100LL (ASTM D910)</p> <p>50 LITERS (13.2 U.S. GALS.) TOTAL USABLE CAPACITY</p>	In correspondence of each fuel tank filler cap.

KINDS OF OPERATIONS EQUIPMENT LIST

Equipment	VFR Day	VFR Night	IFR Day	IFR Night
Magnetic compass	•	•	•	•
Airspeed indicator	•	•	•	•
Altimeter	•	•	•	•
Vertical speed indicator	•	•	•	•
Attitude indicator (electric)	•	•	•	•
Turn coordinator	•	•	•	•
OAT indicator	•	•	•	•
Pitot heating system	•	•	•	•
Directional Gyro (electric)	•	•	•	•
Clock	•	•	•	•
Breakers panels	•	•	•	•
First Aid kit	•	•	•	•
Fire extinguisher	•	•	•	•
Fire detectors (2)	•	•	•	•
Instruments lights	•	•	•	•
Position lights	•	•	•	•
Landing light	•	•	•	•
Taxi light	•	•	•	•
Strobe lights	•	•	•	•
Torch		•	•	•
Cabin light		•	•	•
Cockpit lights		•	•	•
Emergency light	•	•	•	•
Volt-Ammeter	•	•	•	•
COMM/NAV/GPS equipment	•	•	•	•
VOR/LOC/GS/GPS CDI	•	•	•	•
LG position and transition lights	•	•	•	•
Transponder	•	•	•	•
Audio Panel/Marker beacon	•	•	•	•
Altitude encoder	•	•	•	•
ELT	•	•	•	•
Alternate static source	•	•	•	•
MAP indicator (dual)	•	•	•	•
RPM indicator (2)	•	•	•	•
Oil pressure indicator (2)	•	•	•	•
Oil temperature indicator (2)	•	•	•	•
CHT (2)	•	•	•	•
Fuel pressure indicator (2)	•	•	•	•
Fuel quantity indicator (2)	•	•	•	•
Longitudinal trim indicator	•	•	•	•
Rudder trim indicator	•	•	•	•
Flaps position indicator	•	•	•	•
Stall warning system	•	•	•	•
Annunciator panel	•	•	•	•
2 nd VHF COMM/NAV equipment		•	•	•
2 nd VOR/LOC/GS CDI			•	•
DME			•	•
ADF	•	•	•	•
2 nd Airspeed indicator			•	•
2 nd Attitude indicator (electric)			•	•
2 nd Altimeter			•	•
	VFR Day	VFR Night	IFR Day	IFR Night

EMERGENCY PROCEDURES**SMOKE AND FIRE OCCURRENCE**

Use ventilation window in case of smoke in cabin for all cases.

NORMAL OPERATIONS

Make reference to Section 4 of this Manual.

PERFORMANCES

LANDING PERFORMANCES

Pressure Altitude		Distance [m]					ISA
		Temperature [°C]					
[ft]		-25	0	25	50		
S.L.	Ground Roll	183	202	220	238	213	
	At 50 ft AGL	288	312	335	358	326	
1000	Ground Roll	190	209	228	247	219	
	At 50 ft AGL	297	321	345	369	334	
2000	Ground Roll	197	217	237	256	226	
	At 50 ft AGL	306	331	356	381	342	
3000	Ground Roll	204	225	245	266	232	
	At 50 ft AGL	325	352	379	405	360	
4000	Ground Roll	212	233	255	276	239	
	At 50 ft AGL	325	352	379	405	360	
5000	Ground Roll	220	242	264	287	247	
	At 50 ft AGL	335	363	391	418	369	
6000	Ground Roll	228	251	275	298	254	
	At 50 ft AGL	346	375	403	431	378	
7000	Ground Roll	237	261	285	309	262	
	At 50 ft AGL	357	387	416	445	388	
8000	Ground Roll	246	271	296	321	270	
	At 50 ft AGL	368	399	430	460	398	
9000	Ground Roll	256	282	308	334	279	
	At 50 ft AGL	380	412	444	475	409	
10000	Ground Roll	266	293	320	347	288	
	At 50 ft AGL	393	426	459	491	420	

Weight = 1180 kg

Flaps: LAND

Short Final Approach Speed = 70 KIAS

Throttle Levers: Idle

Runway: Grass

Corrections

Headwind: - 5m for each kt (16 ft/kt)

Tailwind: + 11m for each kt (36ft/kt)

Paved Runway: - 2% to Ground Roll

Runway slope: -2.5% to Ground Roll for each +1%

For dry and precipitation-covered runway:

+67% to ground roll for destination airport

+43% to ground roll for alternate airport

For wet runway:

+92% to ground roll for destination airport

+64% to ground roll for alternate airport

INTENTIONALLY LEFT BLANK

WEIGHT AND BALANCE

For weight and balance, make reference to Section 6 of this Manual.

INTENTIONALLY LEFT BLANK

SUPPLEMENT NO. G2 – S-TEC FIFTY FIVE X AUTOPILOT FOR GARMIN G950

Record of Revisions

Rev	Revised page	Description of Revision	Tecnam Approval			EASA Approval or Under DOA Privileges
			DO	OoA	HDO	
0	-	See Note (*)				
1	G2-9	Add Warning	M. Landi	M. Oliva	L. Pascale	DOA privileges

Note (*): this Supplement has been originally issued under EASA Major Design Change Approval no. 10029331 (dated 18 March 2010)

List of Effective Pages

Page	Revision	Page	Revision
G2-1	Rev 1	G2-6	Rev 0
G2-2	Rev 0	G2-7	Rev 0
G2-3	Rev 0	G2-8	Rev 0
G2-4	Rev 0	G2-9	Rev 1
G2-5	Rev 0	G2-10	Rev 0

INTRODUCTION

This section contains supplemental information to operate, in a safe and efficient manner, the aircraft when equipped with S-TEC Fifty Five X autopilot device interfacing Garmin G950 IFDS.



GENERAL

The System Fifty Five X is a rate based autopilot. When in control of the roll axis, the autopilot senses turn rate, as well as closure rate to the selected course, along with the non-rate quantities of heading error, course error and course deviation indication.

When in control of the pitch axis, the autopilot senses vertical speed, acceleration, and closure rate to the selected glideslope, along with the non-rate quantities of altitude and glideslope deviation indication.

These sensed data provide feedback to the autopilot, which processes them in order to control the aircraft through the use of mechanisms coupled to the control system.

The “autotrim” function senses when the aircraft needs to be trimmed about the pitch axis, and responds by driving the trim servo in the proper direction to provide trim.

LIMITATIONS (EASA APPROVED)**NOTE**

The S-TEC “Pilot’s Operating Handbook Fifty Five X” (4th Edition – First Revision dated March 01, 2008 or a more updated version) must be carried in the aircraft and made available to the pilot at all time.

NOTE

In accordance with FAA recommendation (AC 00-24B), use of basic “Altitude Hold” mode is not recommended during operation in severe turbulence.

Following operating limitations shall apply when the aircraft is equipped with S-TEC Fifty Five X autopilot:

- The Autopilot is certified for Category I – ILS Approaches [with a decision height not lower than 200 feet AGL (61m)]
- Autopilot operation forbidden with flaps extended more than TO position
- During Autopilot operation, a pilot with seat belt fastened must be seated at the left pilot position
- The use of Autopilot during single engine operation is forbidden
- Autopilot DISC during take-off and landing
- Maximum speed for Autopilot operation is 135 KIAS
- Minimum speed for Autopilot operation is 85 KIAS
- Minimum altitude AGL for Autopilot operation is:
 - a. Cruise and Descent: 1000 ft
 - b. Climb after takeoff and not precision approach: 400 ft
 - c. ILS CAT I precision approach: 200 ft

Section 9 - Supplements

On the instrument panel, in clear view of the pilot, it is placed the following placard reminding the observance of aircraft operating limitations during Autopilot operation:

OPERATING LIMITATIONS FOR AUTOPILOT S-TEC 55X

- Category I – ILS Approaches only (200 ft AGL)
- Do not use AP with flaps extended more than TO position
- Pilot with seat belt fastened must be seated at the left pilot position during AP operation
- Do not use AP during single engine operation
- Do not use AP during take-off and landing
- AP operating speeds range: 85 to 135 KIAS
- Min. altitude AGL for Autopilot operation is:
Cruise and Descent: 1000 ft
Climb after takeoff and not precision approach: 400 ft

Section 9 - Supplements

Supplement no. G2 – S-TEC Fifty Five X Autopilot for Garmin G950

EMERGENCY PROCEDURES**NOTE**

In event of autopilot malfunction, or when the system is not performing as expected or commanded, take immediately the aircraft control disconnecting the autopilot which must be set inoperative until the failure has been identified and corrected.

Altitude lost during a pitch axis autopilot malfunction and recovery

Following table addresses the altitude lost during a pitch axis malfunction and recovery for each reported flight phase:

Flight phase	Altitude loss
Climb	200 ft
Cruise	150 ft
Descent	200 ft
Maneuvering	50 ft
Approach	80 ft

Autopilot hardover or failure to hold the selected heading

In case of Autopilot hardover or failure to hold the selected heading, apply following procedure:

Accomplish items 1 and 2 simultaneously:

- | | |
|-----------------------------|---|
| 1. Airplane control wheel | <i>GRASP FIRMLY and OVERPOWER if necessary to regain aircraft control</i> |
| 2. AP DISC/TRIM INTR switch | <i>PRESS</i> |
| 3. AP MASTER SWITCH | <i>OFF</i> |
| 4. AP Circuit Breaker | <i>PULL</i> |



When Autopilot is disconnected as a consequence of a malfunction, hold the control wheel firmly: it may be necessary up to 35 pounds (15.8 daN) of force on the control wheel to hold the airplane level.

NOTE

When Autopilot is disconnected, it may be necessary operate the pitch trim through either the Manual Electric Trim Switch or the Trim Wheel.

Electric trim malfunction

In case of Electric Trim malfunction (either in AP Autotrim mode or when manually operated through the Manual Electric Trim Switch), apply following procedure:

- | | |
|-----------------------------|-----------------------|
| 1. AP DISC/TRIM INTR switch | <i>PRESS and HOLD</i> |
| 2. TRIM MASTER SWITCH | <i>OFF</i> |
| 3. TRIM Circuit Breaker | <i>PULL</i> |
| 4. AP DISC/TRIM INTR switch | <i>RELEASE</i> |



When Autopilot is disconnected because of a pitch trim malfunction, hold the control wheel firmly: it could be necessary up to 35 pounds (15.8 daN) of force on the control wheel to hold the airplane level.

NOTE

When electric trim is disconnected, it may be necessary operate the pitch trim through the Trim Wheel.

NOTE

When electric trim is disconnected, Autopilot system can be operated both in pitch and roll modes; nevertheless, when a pitch mode (ALT HOLD, VS, GS) is engaged, the Autopilot will provide an annunciation whenever it is necessary to manually trim the aircraft about the pitch axis using the Trim Wheel. Make reference to S-TEC "Pilot's Operating Handbook Fifty Five X" (4th Edition – First Revision dated March 01, 2008 or a more updated version).

Heading information signal lost

When AP is engaged and the heading information is lost (red X on display field – make also reference to Supplement G1 – Emergency procedures), the AP must be disconnected applying following procedure:

Accomplish items 1 and 2 simultaneously:

1. Airplane control wheel *GRASP FIRMLY and OVERPOWER if necessary to regain aircraft control*
2. AP DISC/TRIM INTR switch *PRESS*
3. AP MASTER SWITCH *OFF*
4. AP Circuit Breaker *PULL*
5. Refer to other navigation means for heading information



When Autopilot is disconnected as a consequence of a malfunction, hold the control wheel firmly: it may be necessary up to 35 pounds (15.8 daN) of force on the control wheel to hold the airplane level.

NOTE

When Autopilot is disconnected, it may be necessary operate the pitch trim through either the Manual Electric Trim Switch or the Trim Wheel.

NORMAL OPERATIONS

Normal operating procedures, including pre-flight checks, are described on S-TEC “Pilot’s Operating Handbook Fifty Five X” (4th Edition – First Revision dated March 01, 2008 or a more updated version).

Status/mode annunciations and/or visual representations are simultaneously displayed on both the G950 (AFCS Status Box and/or PFD) and the S-TEC Fifty Five X Autopilot Display.

Make reference to Garmin G950 Pilot’s Guide for Tecnam P2006T (P/N 190-01146-00) – last issue.



The vertical speed mode is used to establish and hold a PILOT selected vertical speed. Since the autopilot receives no airspeed information, it is the responsibility of the pilot to ensure that the vertical speed selection is within the operating limits of the aircraft's capabilities. Selection of a vertical speed beyond the capability of the aircraft can create a condition of reduced airspeed, and possibly lead to a stall condition.

PERFORMANCES

S-TEC Fifty Five X Autopilot employment does not affect the aircraft performances.

WEIGHT AND BALANCE

See Section 6 of this Manual.

SYSTEMS

The System Fifty Five X Block Diagram is shown in the following figure.

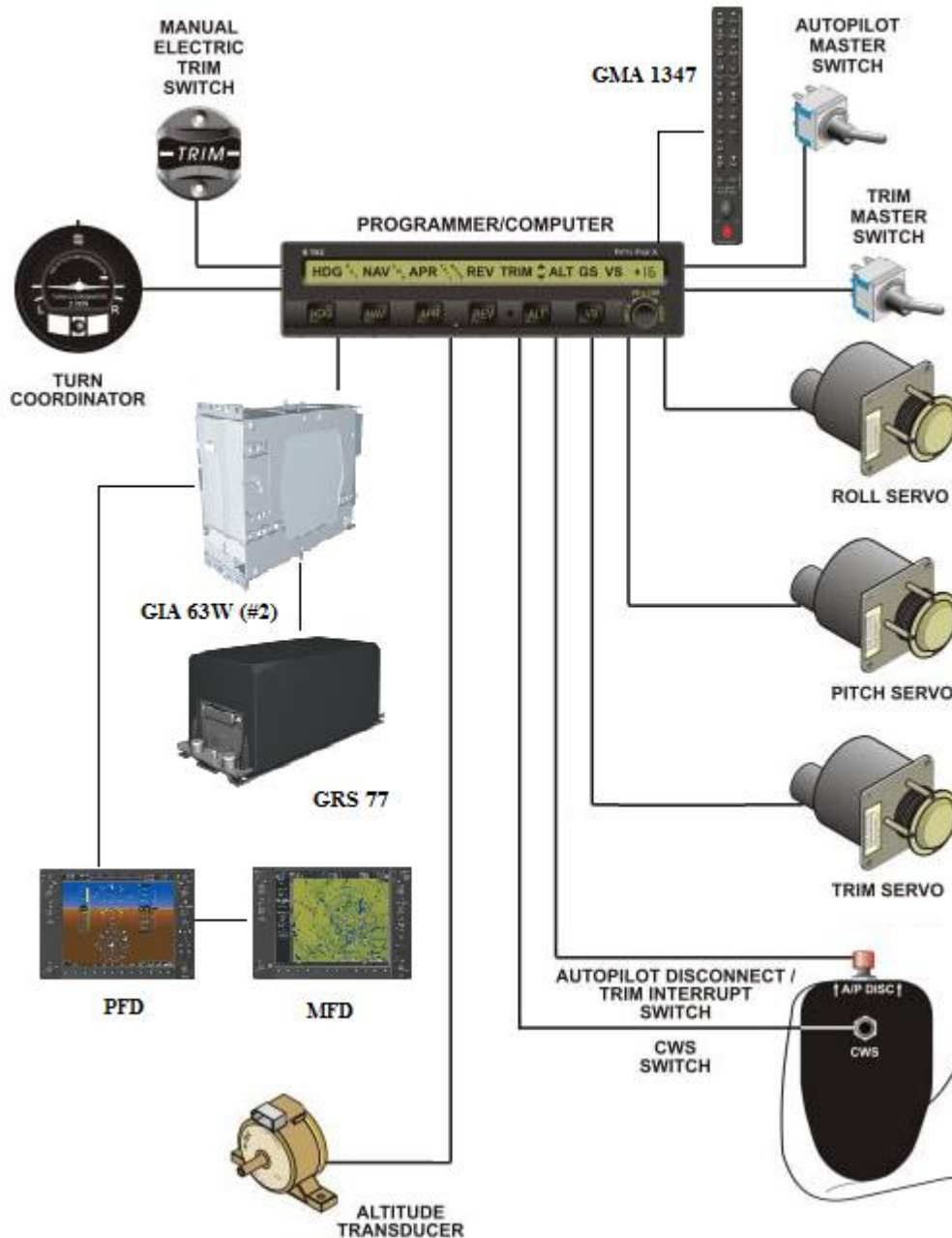

Section 9 - Supplements

SUPPLEMENT NO. G3 – KR 87 ADF SYSTEM FOR GARMIN G950

Record of Revisions

Rev	Revised page	Description of Revision	Tecnam Approval			EASA Approval Or Under DOA Privileges
			DO	OoA	HDO	
0	-	See Note (*)				

Note (*): this Supplement has been originally issued under EASA Major Design Change Approval no. 10029633 (dated 8 April 2010)

List of Effective Pages

Page	Revision	Page	Revision
G3-1	Rev 0	G3-3	Rev 0
G3-2	Rev 0	G3-4	Rev 0

INTRODUCTION

This section contains supplemental information to operate, in a safe and efficient manner, the aircraft when equipped with ADF KR 87 device in conjunction with Garmin G950 system.



GENERAL

KR 87 is an ADF for navigation with respect to the Non Directional Beacon stations.

LIMITATIONS

ADF KR 87 manuals do not address operating limitations more severe than those usually applicable to the P2006T.

EMERGENCY PROCEDURES

Particular meteorological conditions can distort the equipment indications. Therefore, to avoid false indications about NDB direction, it is necessary to select ANT function in order to query the selected station and to listen to its identification code.

Near electrical interferences (electrical storms), ADF indicator tends to head toward the interferences themselves. Take into account this likelihood when the indicator heads, for example, toward highly cloudy or stormy zones.

Wrong indications could arise also during night flights, near mountainous reliefs and as effect of the coastal refraction.

NORMAL OPERATIONS

Normal operating procedures are reported on the following documents:

- 1) Garmin G950 Pilot's Guide for Tecnam P2006T (P/N 190-01146-00) – last issue.
- 2) ADF system "Pilot's guide and Reference", P/N KIKR87-PG-C - last issue.

Bearing information is displayed on the Garmin G950 PFD, to the lower sides of the HSI: the PFD softkeys BRG1 and BRG2 cycles respectively Bearing 1 and Bearing 2 Information Window through the different bearing sources, including ADF/frequency.

Pressing the ADF Key on the GMA 1347 Audio Panel turns ADF receiver audio on or off on the headset/speaker.

PERFORMANCES

ADF KR-87 employment does not affect the aircraft performances.

WEIGHT AND BALANCE

See Section 6 of this Manual.

SYSTEMS

Refer to the guide “KR-87” P/N KIKR87-PG-C for a system description. The interface with Garmin G950 is shown on the following Figure.

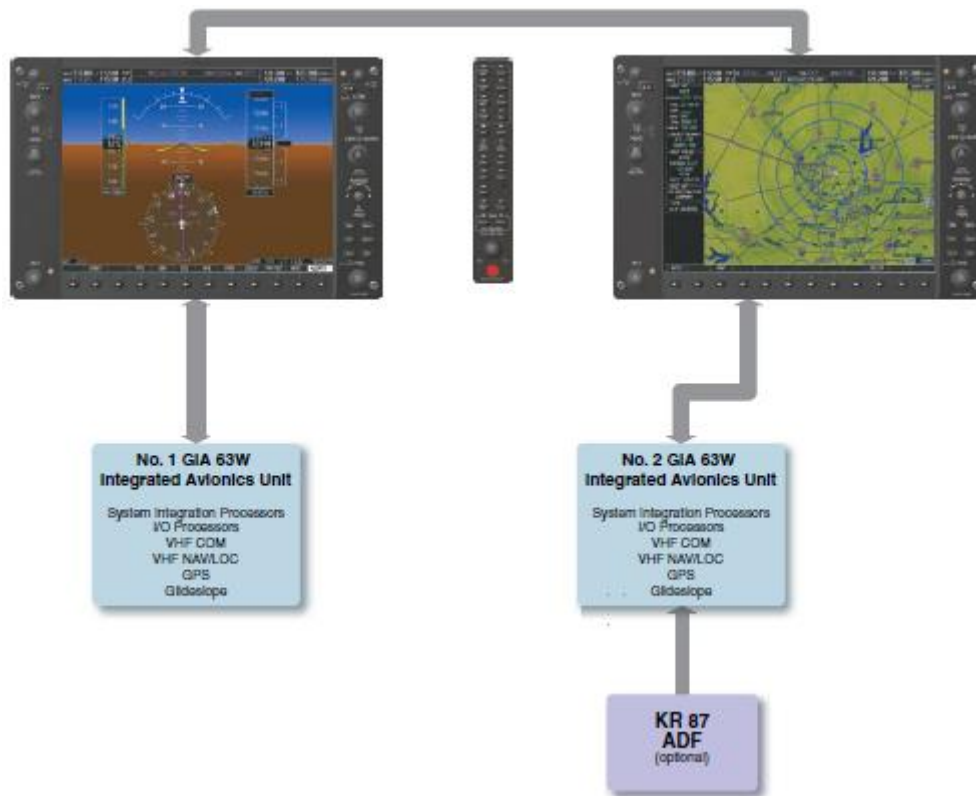

SUPPLEMENT NO. G4 – KN 63 DME SYSTEM FOR GARMIN G950

Record of Revisions

Rev	Revised page	Description of Revision	Tecnam Approval			EASA Approval Or Under DOA Privileges
			DO	OoA	HDO	
0	-	See Note (*)				

Note (*): this Supplement has been originally issued under EASA Major Design Change Approval no. 10029633 (dated 8 April 2010)

List of Effective Pages

Page	Revision	Page	Revision
G4-1	Rev 0	G4-3	Rev 0
G4-2	Rev 0	G4-4	Rev 0

INTRODUCTION

This section contains supplemental information to operate, in a safe and efficient manner, the aircraft when equipped with DME KN 63 device in conjunction with Garmin G950 system.

GENERAL

KN 63 is a DME equipment fitted with a remote module interfacing the Garmin G950 system. Indications are displayed above the PFD BRG1 Information Window.

LIMITATIONS

DME KN 63 manuals do not address operating limitations more severe than those usually applicable to the P2006T.

EMERGENCY PROCEDURES

In determined conditions, near the beacon, DME signal can be lost or distorted. Take into account this likelihood when a beacon approach is performed.

NORMAL OPERATIONS

Normal operating procedures are reported on Garmin G950 Pilot's Guide for Tecnam P2006T (P/N 190-01146-00) – last issue.

Make reference also to “KN 63 Installation Manual”, P/N 006-00176 Rev. 4 dated October 2004.

The PFD softkey DME displays the DME Tuning Window, allowing tuning and selection of the DME.

The DME Information Window is displayed above the BRG1 Information Window and shows the DME label, tuning mode (NAV1, NAV2, or HOLD), frequency, and distance. When a signal is invalid, the distance is replaced by “-- -- NM”.

Pressing the DME Key on the GMA 1347 Audio Panel turns DME audio on or off on the headset/speaker.

PERFORMANCES

DME KN 63 employment does not affect the aircraft performances.

WEIGHT AND BALANCE

See Section 6 of this Manual.

SYSTEMS

Refer to the guide “KN 63 Installation Manual”, P/N 006-00176 Rev. 4 dated October 2004 for a complete system description. The interface with Garmin G950 is shown on the following Figure.

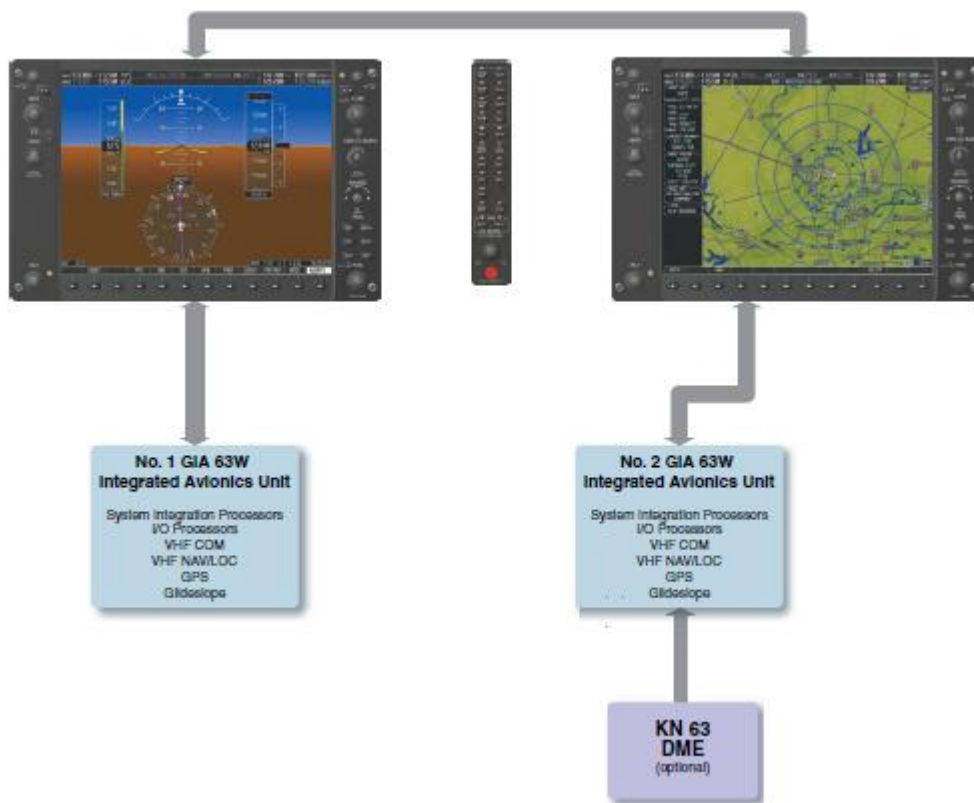

INTENTIONALLY LEFT BLANK

Section 9 - Supplements

Supplement no. G4 – KN 63 DME System for Garmin G950

SUPPLEMENT NO. G5 – ENGINE STARTING BATTERY
Record of Revisions

Rev	Revised page	Description of Revision	Tecnam Approval			EASA Approval or Under DOA Privileges
			DO	OoA	HDO	
0	-	See Note (*)				
1	G5-2	amend emergency procedures	D. Ronca	G.Paduano	M.Oliva	DOA privileges

Note (*): this Supplement has been originally issued under EASA Major Design Change Approval no. 10031750 (dated 9 September 2010)

List of Effective Pages

Page	Revision	Page	Revision
G5-1	Rev 0	G5-3	Rev 0
G5-2	Rev 0	G5-4	Rev 0

INTRODUCTION

This section contains information to operate the airplane equipped with a supplemental battery dedicated to engines starting.

GENERAL

The engine starting battery is housed in a dedicated box under the main battery box: both batteries are accessible through the inspection cap F10 on the left side of the tail cone.

LIMITATIONS

See Section 2 of this Manual.

EMERGENCY PROCEDURES

In event of the following failure conditions, addressed on Section 3 of this Manual and leading to fly without power generation system:

- **Both generators failure (Para. 3.1)**
- **Both generators overvoltage (Para 3.3)**
- **Inflight engine restart (Para 8.2)**

apply, at the end of related checklist, following procedure:

EMERG BATT switch *ON*



push the Emergency battery switch to ON to avoid a power generation system failure.

NORMAL OPERATIONS

During Cockpit Inspections (see Para. 3.2 – Section 4 of this Manual), perform also following check:

Eng. Starting Battery Voltmeter *CHECK 12 to 14 Volt*

PERFORMANCES

See Section 5 of this Manual.

WEIGHT AND BALANCE

For weight and balance, make reference to Section 6 of this Manual; additionally, the equipment list reported on Para. 5 is so integrated:

EQUIPMENT LIST		AIRCRAFT S/N__	DATE:		
REF.	DESCRIPTION	P/N	INST	WEIGHT [kg]	ARM [M]
<i>AVIONICS & MISCELLANEOUS</i>					
A14-1	Engine Starting Battery (EnerSys SBS8)		X	2.7	3.7

SYSTEMS

When airplane embodies the design change in subject, in addition to the main battery, a dedicated engine starting battery is introduced.

The entire primary loads stand connected to the main battery itself and the engine starting battery is recharged by the generators.



This modification is transparent to the crew because it does not change deeply the usual normal and emergency procedures.

Additionally, in event of the overall loss of power generation, the starting battery can be put in parallel with the main battery by means of the EMERG BATT switch activation.

In order to allow the charging status check of the battery, a voltmeter is provided. Pushing the button close to the voltmeter, crew can read the battery status.

Both batteries are accessible through the inspection cap F10 on the left side of the tail cone.

When the design change in subject is embodied, following placards are installed on the airplane:

Description	Placard	Place
Engine starting battery voltmeter location		Close to the voltmeter
Batteries compartment location		Fuselage tail cone, left side

SUPPLEMENT NO. G6 – POWER SUPPLY FROM BUILT-IN GENERATORS

Record of Revisions

Rev	Revised page	Description of Revision	Tecnam Approval			EASA Approval or Under DOA Privileges
			DO	OoA	HDO	
0	-	See Note (*)				

Note (*): this Supplement has been originally issued under EASA Major Design Change Approval no. 10031748, rev 1 (dated 17 November 2010)

List of Effective Pages

Page	Revision	Page	Revision
G6-1	Rev 0	G6-4	Rev 0
G6-2	Rev 0	G6-5	Rev 0
G6-3	Rev 0	G6-6	Rev 0

INTRODUCTION

This section contains information to operate the airplane equipped with built-in generators.

GENERAL

The Rotax engine built-in generators, one for each engine, feed two bus bars.

LIMITATIONS (EASA APPROVED)

Following limitations must apply when the built in generators are operative:

During Take-off, Climb, Landing and Single Engine operations:

LH and RH AUX FIELD switch

BOTH OFF

EMERGENCY PROCEDURES

In event of the following failure conditions (addressed on Section S3 of this Manual):

- **Single Engine operations**
- **Single generator failure (Para. 3.2)**
- **Single generator overvoltage (Para 3.4)**
- **Both generators failure (Para. 3.1)**
- **Both generators overvoltage (Para 3.3)**
- **Engine securing (Para. 5)**
- **Electrical system overall failure (Para. 7.1)**
- **All smoke and fire occurrences (Para 10.1 to 10.5)**

apply following procedure:

LH and RH AUX FIELD switch

BOTH OFF

NORMAL OPERATIONS

See Section 4 of this Manual.

PERFORMANCES

See Section 5 of this Manual.

WEIGHT AND BALANCE

See Section 6 of this Manual.

SYSTEMS

When the airplane embodies the design change in subject, the Rotax engine built-in generators are enabled in order to supply power to two bus bars.

Each built-in generator is activated by means of a switch (LH and RH AUX FIELD) located on the LH breakers rack where are located also the breakers related to the auxiliary power generation system.



LH breakers rack: built-in generators field switches and system related breakers (panel type 1)

When panel type 2 is installed (see picture below), each generator field is first excited selecting START on the toggle switch. Then, to allow power generation, toggle switch must be set to ON position.



LH breakers rack: built-in generators field switches and system related breakers (panel type 2)

For both panels, the light (switch built-in light for panel 1) indicates that the electrical power is generated.

Section 9 - Supplements

Supplement no. G6 – POWER SUPPLY FROM BUILT-IN GENERATORS

INTENTIONALLY LEFT BLANK

Section 9 - Supplements

Supplement no. G6 – POWER SUPPLY FROM BUILT-IN GENERATORS

SUPPLEMENT NO. G7

AFM SUPPLEMENT FOR CIS COUNTRIES OPERATORS

Record of Revisions

Rev	Revised page	Description of Revision	Tecnam Approval			EASA Approval or Under DOA Privileges
			DO	OoA	HDO	
0	-	See Note (*)				

Note (*): this Supplement has been originally issued on 12 November 2010, after EASA Third Country Validation process completion.

List of Effective Pages

Page	Revision	Page	Revision
G7-1	Rev 0	G7-13	Rev 0
G7-2	Rev 0	G7-14	Rev 0
G7-3	Rev 0	G7-15	Rev 0
G7-4	Rev 0	G7-16	Rev 0
G7-5	Rev 0	G7-17	Rev 0
G7-6	Rev 0	G7-18	Rev 0
G7-7	Rev 0	G7-19	Rev 0
G7-8	Rev 0	G7-20	Rev 0
G7-9	Rev 0	G7-21	Rev 0
G7-10	Rev 0	G7-22	Rev 0
G7-11	Rev 0	G7-23	Rev 0
G7-12	Rev 0	G7-24	Rev 0

TABLE OF CONTENTS

INTRODUCTION	3
GENERAL	3
LIMITATIONS (EASA APPROVED)	4
Approved maneuvers	4
Ambient Temperature	4
Flight Altitude	4
Airfield elevation	4
Operation from unpaved runways	4
Over-water flights	5
Flight crew	5
Other placards	6
EMERGENCY PROCEDURES	8
Smoke and fire occurrence	8
Failure of Control System	8
Loss of Stabilator Control	8
Loss of Aileron Control	9
Loss of Rudder Control	9
One engine inoperative procedures	10
Characteristic airspeeds with one engine inoperative	10
Inflight engine restart	11
Landing emergencies	12
Landing without engine power	12
Landing on the Airfield	12
NORMAL OPERATIONS	13
Cold weather operations	13
Airspeeds for normal operations	13
Aircraft walk-around	14
Cockpit inspections	15
Takeoff and climb	16
Cruise	16
Balked landing	17
PERFORMANCES	18
Takeoff performances	18
climb performance (one engine inoperative)	20
WEIGHT AND BALANCE	21
SYSTEMS	22
Instruments panel	22

INTRODUCTION

This supplement applies for CIS countries operators.

GENERAL

This supplement must be placed in EASA Approved P2006T Aircraft Flight Manual Section 9, if the airplane is certified to the CIS configuration. The information contained herein complements the basic information in the EASA Approved Aircraft Flight Manual. For limitations, procedures, and performance information not contained in this supplement, refer to the EASA Approved Aircraft Flight Manual.

LIMITATIONS (EASA APPROVED)

APPROVED MANEUVERS

Non aerobatic operations include:

- Any manoeuvre pertaining to “normal” flight
- Stalls
- Lazy eights
- Turns in which the angle of bank is not more than 60°
- Chandelle



Acrobatic manoeuvres, including whip stalls, spins and turns with angle of bank of more than 60°, are not approved for such a category. In addition, stall with one engine inoperative is forbidden.



Limit load factor could be exceeded by moving flight controls to maximum deflection at a speed above $V_A=V_O$ (118 KIAS, Manoeuvring Speed).

AMBIENT TEMPERATURE

Ambient temperature: from -25°C to +40°C.

FLIGHT ALTITUDE

Flight Altitude limitation: 3000 m (9800ft) and 3600 m (11800ft) for max. 30 minutes.

AIRFIELD ELEVATION

Maximum airfield elevation (Pressure Altitude): less than 2400 m (8000ft).

OPERATION FROM UNPAVED RUNWAYS

Operation from unpaved runways is limited by soil strength of 6 kg per sq. centimeter ($\sigma \geq 6 \text{kg/cm}^2$).

OVER-WATER FLIGHTS

Extended over-water flights are allowed within the limitations prescribed by CIS operational regulations.

FLIGHT CREW





Minimum permitted: 1 pilot



Maximum people on board: 4 people (including pilot)

NOTE

If right control wheel is not removed, right seat may be occupied by the crew member.

OTHER PLACARDS

Description	Placard	Place
Smoking ban		Instruments panel, right side
Ditching emergency exit: opening instructions	 <p data-bbox="507 925 991 1037"> АВАРИЙНЫЙ ВЫХОД НА ВОДУ 1. Повернуть 2. Сильно толкнуть дверь </p>	Ditching emergency exit handle: internal side
Ditching emergency exit: opening instructions	 <p data-bbox="507 1328 991 1440"> АВАРИЙНЫЙ ВЫХОД НА ВОДУ 1. Повернуть 2. Сильно толкнуть дверь </p>	Ditching emergency exit handle: external side
Door locking system: bypass instructions	 <p data-bbox="469 1731 962 1883"> ДЛЯ АВАРИЙНОГО ДОСТУПА 1. Нажать вниз и удерживать красный флажок 2. Открыть дверь </p>	Main door and emergency exit: external side

Description	Placard	Place
Door locking system: bypass instructions	 <p> ДЛЯ АВАРИЙНОГО ВЫХОДА 1. Нажать вниз и удерживать красный флажок 2. Открыть дверь </p>	Main door and emergency exit: internal side
Main door: exit instructions	 <p> ПРЕДУПРЕЖДЕНИЕ Перед открытием двери убедиться, что винт остановлен Выход в переднюю часть самолета </p>	Main door, internal side
Emergency exit label	<p style="text-align: center;"> EMERGENCY EXIT АВАРИЙНЫЙ ВЫХОД </p>	Emergency exit: internal and external side

EMERGENCY PROCEDURES

SMOKE AND FIRE OCCURRENCE

Use ventilation window in case of smoke in cabin for all cases.

FAILURE OF CONTROL SYSTEM

LOSS OF STABILATOR CONTROL

In case of loss of pilot side stabilator control (disconnected or jammed), apply following procedure:

1. Continue the flight at the speed of 80 - 85 KIAS due to the aircraft weight in cruise configuration.
2. Bank angle: not more than 30° during turning.
3. Control the aircraft with mechanical trim and engine power setting.

NOTE

The increase of thrust causes a nose up moment; the decrease of thrust causes a nose down moment. The control by trim operation is related to the trim position: trim UP for aircraft nose Up; trim DOWN for aircraft nose DOWN.



CAUTION

Perform approach and landing only in cruise configuration (Flap 0°).

It is necessary to move the landing gear in down position before starting the glide and to balance the aircraft with trim and thrust.

It is possible to correct the glide path by trim operation to minimize the thrust engines changes.

Only after touchdown it is possible to move the engine controls in idle position.

Land as soon as possible.

LOSS OF AILERON CONTROL

In case of loss of pilot side aileron control (disconnected or jammed), apply following procedure:

1. Continue flight at the speed of 80 - 85 KIAS due to the aircraft weight in cruise configuration.
2. Control the airplane bank angle by means of the rudder.
3. Bank angle: not more than 30° during turning.
4. **Land as soon as practical.**

**CAUTION**

Perform approach and landing only in cruise configuration (Flap 0°).

Perform approach and landing with crosswind trend type landing.

LOSS OF RUDDER CONTROL

In case of loss of pilot side rudder control (disconnected or jammed), apply following procedure.

1. Continue flight at the speed of 80 - 85 KIAS due to the aircraft weight in cruise configuration.
2. Control airplane bank angle by means of ailerons.
3. Bank angle: not more than 30° during turning.
4. **Land as soon as practical.**

**CAUTION**

Perform approach and landing only in cruise configuration (Flap 0°).

Perform approach and landing with crosswind trend type landing.

ONE ENGINE INOPERATIVE PROCEDURES

NOTE

The ineffectiveness of one engine results in an asymmetric traction condition which tends to yaw and to bank the aircraft. In this condition it is essential to maintain the direction of flight compensating the lower traction through the operating engine and counteracting the yawing effects through the use of pedals and rudder trim. To improve the efficiency, it is preferred to bank the aircraft to the side of the operating engine by about 5°.

Depending upon the circumstances that may arise, apply the emergency procedure as below.

CHARACTERISTIC AIRSPEEDS WITH ONE ENGINE INOPERATIVE

In case of one engine inoperative condition, pilot shall take into account the airspeeds shown below:

Conditions	Speed (KIAS)
Minimum aircraft control speed with one engine inoperative and flaps set to T.O. (V_{MC})	62
Best rate-of-climb speed with flaps set to T.O. (V_Y)	70
Best rate-of-climb speed with one engine inoperative with flaps set to 0° (V_{YSE})	80 (1180kg) 78 (1080kg) 75 (980kg)

NOTE

Perform approach and landing only with flap set at 0°.

INFLIGHT ENGINE RESTART

NOTE

It is preferred to restart the engine at an altitude below 4000ft and at the suggested speed of 80 KIAS or more

- | | |
|------------------------------------|--------------------------------------|
| 1. Carburettor heat | <i>ON if required</i> |
| 2. Electrical fuel pump | <i>ON</i> |
| 3. Fuel quantity indicator | <i>CHECK</i> |
| 4. Fuel Selector | <i>CHECK (Crossfeed if required)</i> |
| 5. FIELD | <i>OFF</i> |
| 6. Ignition | <i>BOTH ON</i> |
| 7. Operating engine Throttle Lever | <i>IDLE (only if practical)</i> |
| 8. Stopped engine Throttle Lever | <i>IDLE</i> |
| 9. Stopped engine Propeller Lever | <i>FULL FORWARD</i> |
| 10. Start push-button | <i>PUSH</i> |
| 11. Propeller Lever | <i>SET at desired rpm</i> |
| 12. FIELD | <i>ON</i> |
| 13. Engine throttle levers | <i>SET as required</i> |

NOTE

If the fuel quantity in the tank which feeds the stopped engine is low, select the opposite side fuel tank by means of the fuel selector.

NOTE

After starter engagement during in-flight engine restart, PFD indication may be temporarily lost. PFD Attitude recovery can last up to 3-4 minutes. During attitude recovery it is necessary to maintain level straight-line flight.

In case of unsuccessful engine restart:

1. SECURE engine (see *engine securing procedure* on Para. 5)
2. **Land as soon as practical** applying *one engine inoperative landing procedure*. See Para. 8.6

In case of successful engine restart:

1. **Land as soon as practical**



After engine restart, if practical, moderate propeller rpm to allow the temperatures for stabilizing in the green arcs.

LANDING EMERGENCIES

LANDING WITHOUT ENGINE POWER

Landing on the Airfield



CAUTION

Both engines failure condition requires both propellers feathered and aircraft attitude set to maximum efficiency until the selection of the field, on which to perform an emergency landing, is made.

- | | | |
|----|----------------------------|---|
| 1. | Airspeed (VY+4kts) | 84 KIAS (1180kg)
82 KIAS (1080kg)
79 KIAS (980kg) |
| 2. | Flaps | <i>Only 0°</i> |
| 3. | Landing gear control lever | <i>DOWN</i> |



CAUTION

To shorten the landing gear extension time, evaluate the possibility to use the emergency extension control. In this way the time required to complete the extension is shorter by about 8 sec.

- | | | |
|----|---|---------------|
| 4. | Select landing field (check for obstacles and wind) | |
| 5. | Safety belts | <i>FASTEN</i> |

Before touch down

- | | | |
|----|----------------------|-----------------|
| 6. | Fuel Selector | <i>BOTH OFF</i> |
| 7. | Electrical fuel pump | <i>BOTH OFF</i> |
| 8. | Ignitions | <i>ALL OFF</i> |
| 9. | MASTER SWITCHES | <i>ALL OFF</i> |



WARNING

Emergency Landing outside of airfield shall be performed with landing gear retracted and starting flaps extension in FULL configuration at 50 ft of altitude. To reach the maximum gliding distance at the optimal airspeed above mentioned, and to reduce the loss of altitude during a 180° turn, turn with 30° bank angle.

NOTE

The distance covered in correspondence of the optimal speed V_Y is about 4000 meters by 1000ft of altitude.

NOTE

The loss of altitude, when a 180° turn is performed with bank angle of 30°, is about 200ft in correspondence of V_Y .

NORMAL OPERATIONS

COLD WEATHER OPERATIONS

If the aircraft is operated in cold weather conditions (from -25°C till -5°C) it is necessary to perform following procedures:

- Heat the cabin to +25°C to avoid windshield frost in flight
- Heat the engines with external source to + 20° C
- Check the pressure in hydraulic system, recharge if necessary

AIRSPEEDS FOR NORMAL OPERATIONS

The following airspeeds are those which are significant for normal operations.

	FLAPS	1180kg (2600lb)
Rotation Speed (in takeoff, V_R)	T/O	64 KIAS
Speed over a 15 meters obstacle (V_{obs}) Take Off	T/O	70 KIAS
Best Angle-of-Climb Speed (V_X)	0°	80 KIAS
Best Rate-of-Climb speed (V_Y)	0°	80 KIAS
Approach speed	T/O	90 KIAS
Speed over a 15 meters obstacle (V_{obs}) Landing	T/O	70 KIAS
Final Approach Speed	FULL	70 KIAS
Manoeuvring speed (V_A)	0°	118 KIAS
Never Exceed Speed (V_{NE})	0°	167 KIAS

For training purposes, keep speed above following reference data before setting one engine to *zero* thrust condition (i.e. propeller lever full forward and throttle lever set at 15 mmHg MAP):

Safe single engine speed with flaps T/O (V_{SSE})	70 KIAS
Safe single engine speed with flaps 0° (V_{SSE})	80 KIAS (1180kg) 78 KIAS (1080kg) 75 KIAS (980kg)

AIRCRAFT WALK-AROUND

In addition to the aircraft walk-around checklist reported on basic AFM, Section 4, perform following checks:

Left and right wing leading edge *Check stall strip.*

COCKPIT INSPECTIONS

NOTE

Make sure that passengers are familiar with the safety belts and emergency exits employment and that they do not smoke on board. Passengers boarding, paying attention to the propeller disc, is under the pilot's responsibility.



CAUTION

Clean the displays using a clean, lint-free cloth and an eyeglass lens cleaner that is specified as safe for anti-reflective coatings. Cleaners containing ammonia will harm the anti-reflective coating.

- | | |
|---------------------------------|---|
| 1. Parking brake | <i>CHECK ENGAGED</i> |
| 2. AFM and Garmin Pilot's Guide | <i>CHECK on board</i> |
| 3. Weight and balance | <i>CHECK if within the limits</i> |
| 4. Flight controls | <i>Remove seat belt used as lock</i> |
| 5. PFD and MFD | <i>CHECK clean and set altitude displaying in meters (see G950 Pilot's Guide)</i> |
| 6. Seat | <i>Adjust as required</i> |
| 7. Seat belt | <i>Fastened</i> |
| 8. Passenger briefing | <i>Completed</i> |
| 9. Doors | <i>CLOSED AND LOCKED</i> |
| 10 Landing gear control lever | <i>CHECK DOWN</i> |
| 11 Breakers | <i>All ON</i> |
| 12 MASTER SWITCH | <i>ON</i> |
| 13 Fuel quantity | <i>CHECK</i> |
| 14 RH fuel selector | <i>RIGHT</i> |
| 15 LH fuel selector | <i>LEFT</i> |
| 16 RH Electrical Fuel Pump | <i>ON, check fuel pressure gauge correct operation.</i> |
| 17 RH Electrical Fuel pump | <i>OFF, check pressure decreased at zero</i> |
| 18 LH Electrical Fuel Pump | <i>ON, check fuel pressure gauge correct operation.</i> |
| 19 LH Electrical Fuel pump | <i>OFF, check pressure decreased at zero</i> |
| 20 Strobe light | <i>ON</i> |
| 21 Landing gear lights | <i>TEST</i> |
| 22 ELT | <i>CHECK set to ARM</i> |
| 23 Fire detector | <i>TEST</i> |
| 24 Engine levers friction | <i>Adjust if required</i> |
| 25 Flight controls | <i>CHECK free</i> |
| 26 Alternate static port | <i>CHECK closed</i> |
| 27 Cabin heat | <i>CLOSED</i> |
| 28 Flaps | <i>Operate control to FULL position, verifying extension. Then retract flaps.</i> |
| 29 Pitch trim control | <i>Set to neutral position.</i> |
| 30 Rudder trim control | <i>Set to neutral position.</i> |

TAKEOFF AND CLIMB

- | | | |
|----|--|--|
| 1 | Call TWR for takeoff | |
| 2 | Check for clear final and wind on runway | <i>Direction and intensity</i> |
| 3 | LH and RH Electrical Fuel pump | <i>BOTH ON</i> |
| 5 | Carburettors heat | <i>CHECK OFF</i> |
| 8 | LH and RH Propeller Lever | <i>FULL FORWARD</i> |
| 9 | LH and RH Throttle Lever | <i>FULL THROTTLE (about 2400 ± 100 propeller rpm)</i> |
| 10 | Engines instruments | <i>Parameters within green arcs</i> |
| 11 | Rotation speed | <i>V_r = 64 KIAS</i> |
| 12 | Rotation and takeoff | |
| 13 | Apply slightly brakes to stop wheel spinning | |
| 14 | Landing gear control knob | <i>UP: check green lights and TRANS light turned OFF</i> |
| 15 | Speed over obstacle | <i>70KIAS</i> |
| 16 | Flaps | <i>0° at 300 ft (AGL)</i> |
| 21 | Landing and taxi lights | <i>OFF</i> |
| 17 | Establish climb rate | <i>Above 80 KIAS</i> |
| 18 | Trim adjustment | |
| 19 | LH and RH Propeller Lever | <i>Set at 2250 rpm (after reaching safe altitude)</i> |
| 20 | LH and RH Electrical Fuel pump | <i>BOTH OFF</i> |

CRUISE

Flights in the CIS airspace are allowed only along the routes with continuous ATC monitoring using RBS mode in VHF covering zones.

- | | | |
|---|---|---|
| 1 | Reach cruise altitude | |
| 2 | Set throttle and rpm as required for the cruise | |
| 3 | LH and RH Propeller Lever | <i>SET to 1900-2400 rpm</i> |
| 4 | Trim | <i>As required</i> |
| 5 | Engine parameters check (LH and RH) | |
| | • Oil temperature: | <i>90° ÷ 110 ° C.</i> |
| | • CHT: | <i>90° ÷ 110 °C</i> |
| | • Oil pressure: | <i>2 - 5 bar.</i> |
| | • Fuel pressure: | <i>2.2 – 5.8 psi (0.15 - 0.40 bar)</i> |
| 6 | Carburettor heat as needed | <i>(see also instructions addressed on Section 3)</i> |

BALKED LANDING

1	LH and RH Throttle Lever	<i>FULL THROTTLE</i>
2	LH and RH Propeller Lever	<i>FULL FORWARD</i>
3	Speed	<i>Over 70 KIAS</i>
4	Flaps	<i>T/O</i>
5	Landing gear	<i>UP</i>
6	Carburettor heat	<i>CHECK OFF</i>
7	LH and RH Electrical Fuel pump	<i>CHECK ON</i>

PERFORMANCES

TAKEOFF PERFORMANCES

Takeoff ground roll

CONDITIONS:

- Flaps: T/O
- Throttle levers: FULL FORWARD
- Runway: paved

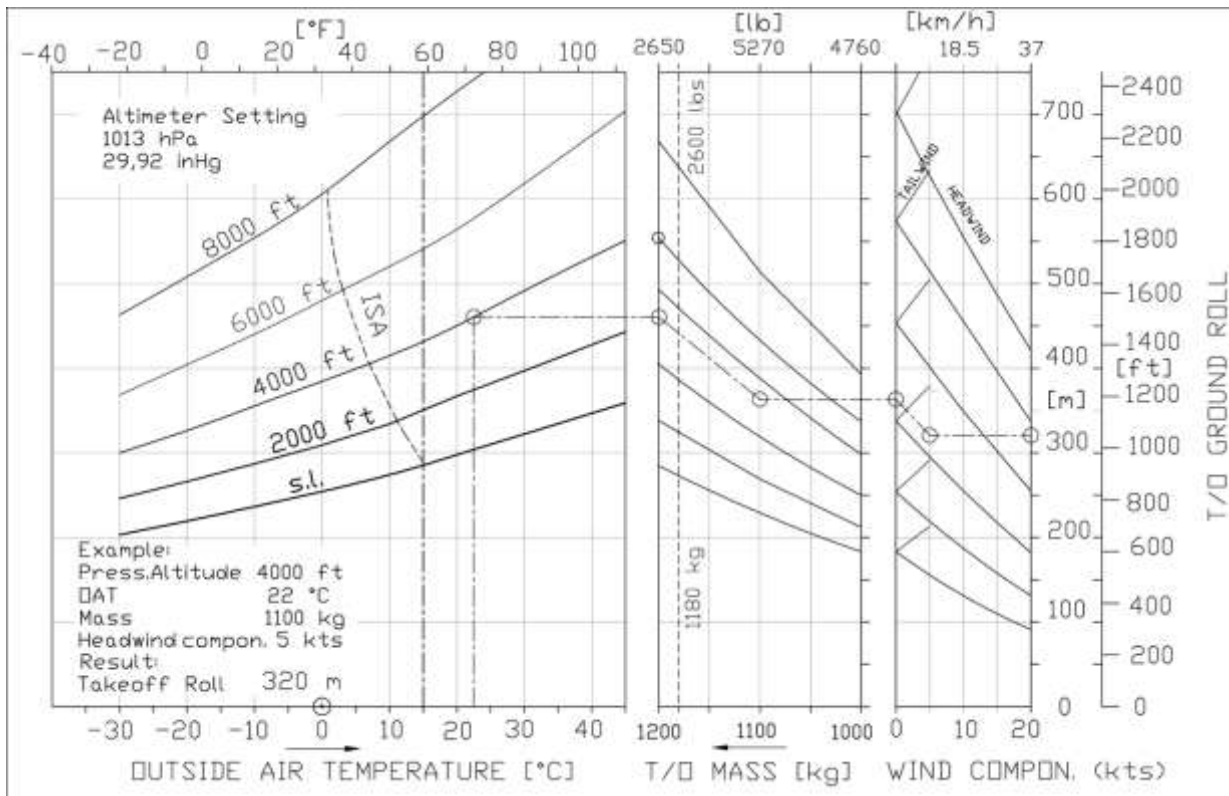

Figure 1 - Takeoff ground roll

NOTE

In case of headwind, the takeoff run decreases by 2.5m for each knot of wind (8 ft/kt).

In case of tailwind, the takeoff run increases by 10m for each knot of wind (33 ft/kt).

*Measurement distances for short grass (less than 2 inches) must be increased of 10%
Measurement distances for high grass (more than 2 inches) must be increased of 15%*

A rising runway with a gradient of 1% causes an acceleration decreasing of the same intensity and, consequently, the takeoff run increases by 5%.

Takeoff distance

CONDITIONS:

- Flaps: T/O
- Throttle levers: FULL FORWARD
- Runway: paved

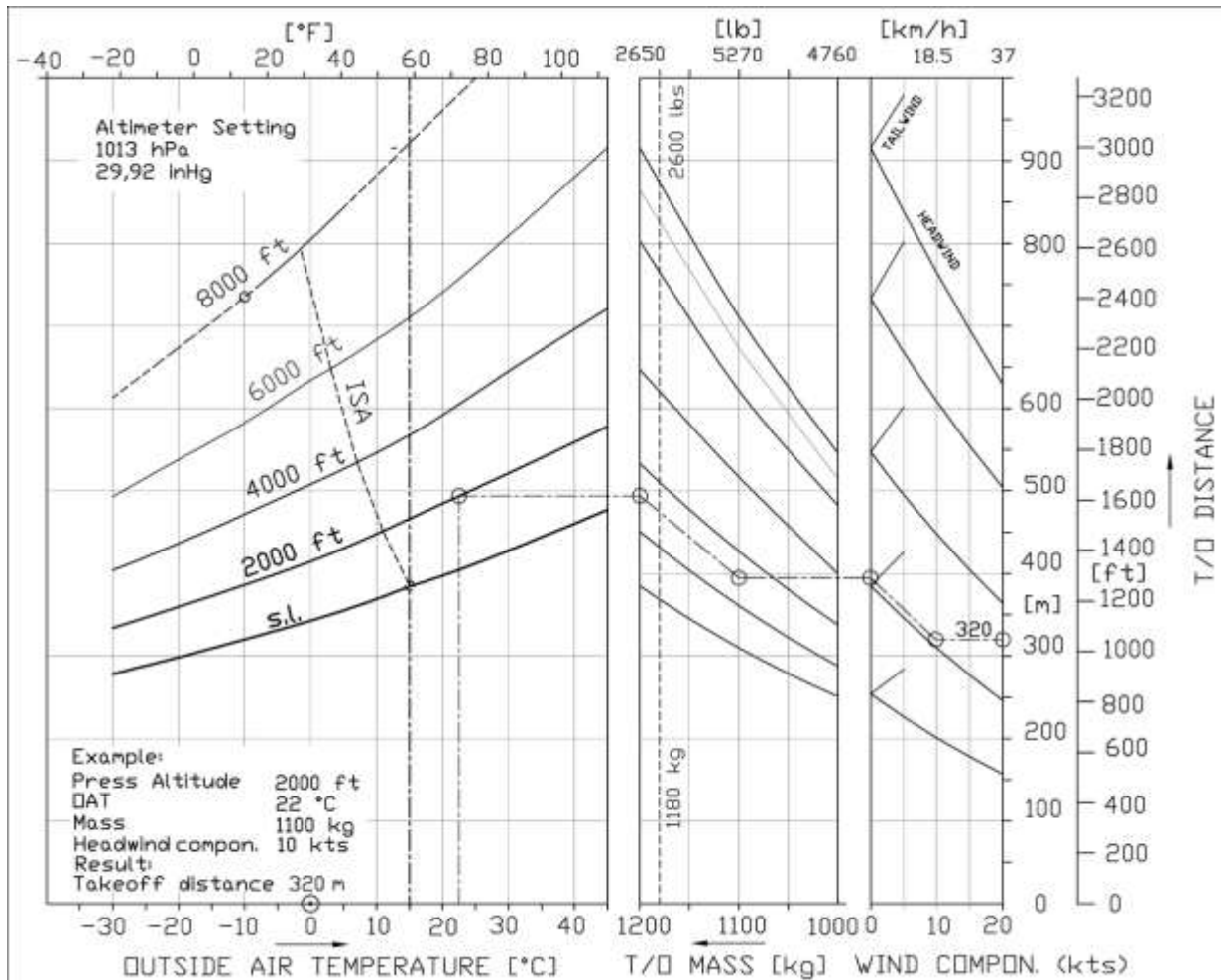

Figure 2 - Takeoff distance (50 ft. Obs)

NOTE

In case of headwind, the takeoff run decreases by 4m for each knot of wind (13 ft/kt).

In case of tailwind, the takeoff run increases by 14m for each knot of wind (40 ft/kt).

Take off roll measurement distances for short grass (less than 2 inches) must be increased of 10%

Take off roll measurement distances for high grass (more than 2 inches) must be increased of 15%

A rising runway with a gradient of 1% causes a takeoff run increasing by about 4%.

CLIMB PERFORMANCE (ONE ENGINE INOPERATIVE)

CONDITIONS:

- AC Clean configuration
- One engine inoperative
- Max Cont. Power – Airspeed:

Weight [kg]	V _{SSE} [KIAS]
1180	80
1080	78
980	75

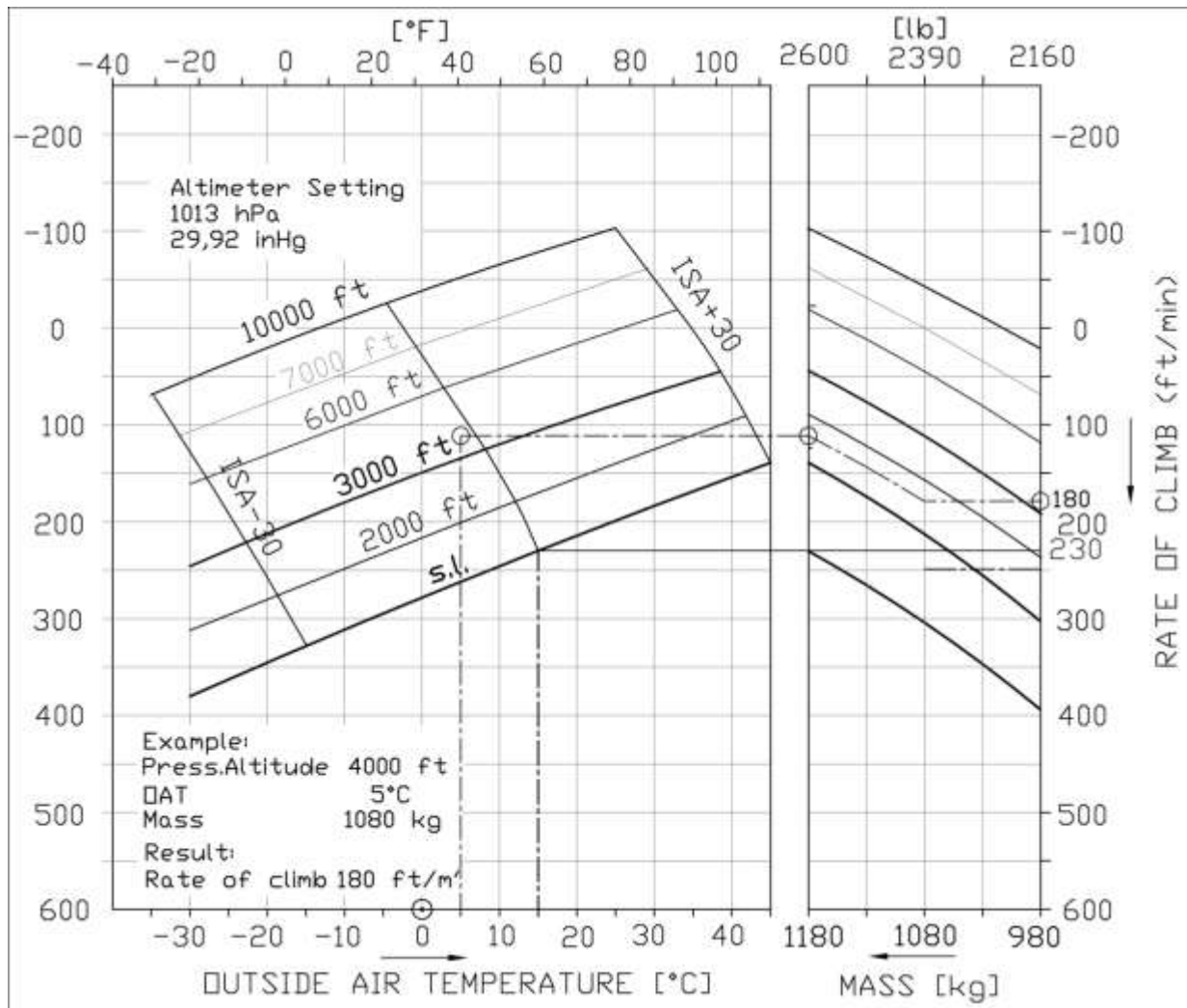

Figure 3 – Rate of Climb (one engine inoperative)

WEIGHT AND BALANCE

For weight and balance, make reference to Section 6 of this Manual.

SYSTEMS

INSTRUMENTS PANEL

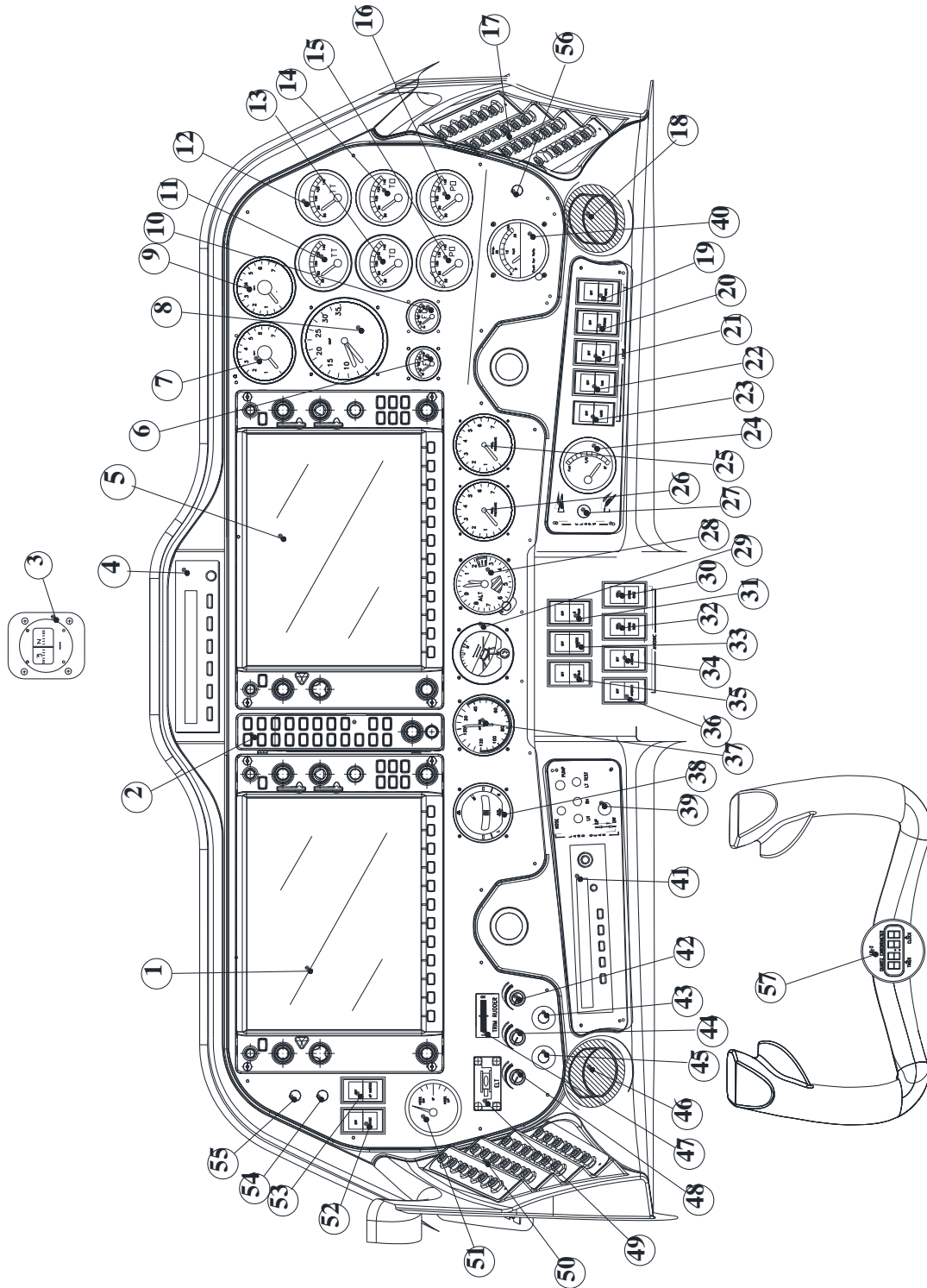

Instruments panel (typical layout)

Item	Description
1	GDU 1040 (PFD)
2	GMA 1347
3	Compass
4	A/P Programmer/Computer
5	GDU 1040 (MFD)
6	LH fuel quantity indicator
7	LH R.P.M.
8	Dual M.A.P. indicator
9	RH R.P.M.
10	RH fuel quantity indicator
11	LH CHT
12	RH CHT
13	LH Oil Temperature
14	RH Oil Temperature
15	LH oil pressure
16	RH oil pressure
17	RH breakers panel
18	RH ram air inlet
19	Instruments light switch
20	Strobe light switch
21	Navigation light switch
22	Taxi light switch
23	Landing light switch
24	Position flaps indicator
25	RH fuel pressure
26	LH fuel pressure
27	Flap switch
28	Standby Altimeter
29	Standby Attitude indicator

Section 9 – Supplements

Supplement no. G7 – AFM Supplement for CIS countries operators

Item	Description
30	RH Cross bus switch
31	RH Field
32	LH Cross bus switch
33	Master switch
34	RH Avionic switch
35	LH Field
36	LH Avionic switch
37	Standby Airspeed indicator
38	Side slip indicator
39	LG control knob
40	Voltammeter Indicator
41	ADF control panel
42	Cockpit light dimmer
43	Cabin heat (warm air from RH engine)
44	Avionics lights dimmer
45	Cabin heat (warm air from LH engine)
46	LH ram air inlet
47	Trim rudder indicator
48	Switches built-in lights dimmer
49	ELT Indicator
50	RH breakers panel
51	Pitch trim indicator
52	Pitot heat switch
53	A/P Master switch
54	A/P trim master switch
55	Fire Detector push-to-test
56	LH/RH Ammeter selector switch
57	Chronometer

Section 9 – Supplements

Supplement no. G7 – AFM Supplement for CIS countries operators

SUPPLEMENT NO. G8

BRAZILIAN AIRCRAFT FLIGHT MANUAL SUPPLEMENT

(EASA APPROVED)

Record of Revisions

Rev	Revised page	Description of Revision	Tecnam Approval			EASA Approval or Under DOA Privileges
			DO	OoA	HDO	
0	-	See Note (*)				

Note (*): this Supplement has been originally issued on 4 March 2011, after EASA Third Country Validation process completion.

List of Effective Pages

Page	Revision	Page	Revision
G8-1	Rev 0	G8-6	Rev 0
G8-2	Rev 0	G8-7	Rev 0
G8-3	Rev 0	G8-8	Rev 0
G8-4	Rev 0	G8-9	Rev 0
G8-5	Rev 0	G8-10	Rev 0

TABLE OF CONTENTS

INTRODUCTION.....	4
GENERAL.....	4
LIMITATIONS.....	5
Approved fuel	5
VHF/COMM system	5
GPS systems	6
GPS operation (for airplanes with autopilot installed)	6
GPS operation (for airplanes without autopilot installed).....	7
WAAS and SBAS functionalities:	7
Placards in portuguese	8

INTRODUCTION

This supplement applies for Brazilian registered aircraft.

GENERAL

Information contained herein complements the basic information in the EASA Approved Aircraft Flight Manual when the aircraft is registered in Brazil.

For limitations, procedures, and performance information not contained in this Supplement, refer to the basic Aircraft Flight Manual.

LIMITATIONS

APPROVED FUEL

APPROVED FUEL: AVGAS 100 LL (ASTM D910)



CAUTION

Use of automotive gasoline (MOGAS) is not allowed for operation in Brazil.



CAUTION

Use of Aviation Fuel Avgas 100LL results in greater wear of valve seats and greater combustion deposits inside cylinders due to higher lead content. Make reference to Rotax Maintenance Manual who provides dedicated checks due to the prolonged use of Avgas.

VHF/COMM SYSTEM

When operating the VHF/COMM system in Brazilian air space, the selection of the channel spacing of 8.33 kHz can cause the loss of communication with the Air Traffic Control (ATC).

GPS SYSTEMS

GPS OPERATION (FOR AIRPLANES WITH AUTOPILOT INSTALLED)

- Use of GPS for precision approach navigation mode is not allowed.
- Use of GPS is prohibited as primary means for navigation. GPS is approved as supplemental means for navigation;
- Navigation using of the GPS system as the source of information is limited to IFR en route, terminal area and non-precision approach mode;
- During IFR in terminal area or non-precision approach using GPS, autopilot or flight director must be coupled to GPS.
- If RAIM function becomes unavailable in “en route” phase of flight, position must be verified every 15 minutes using other IFR approved navigation system;
- During IFR in terminal area or non-precision approach using GPS, in case RAIM function becomes unavailable, the GPS navigation must be discontinued;
- Before an IFR non-precision approach using GPS, the availability of the RAIM function must be checked to the time and place predicted (RAIM prediction). If predicted the unavailability of the RAIM function, navigation must be planned with others approved navigation systems;
- Before a non-precision approach using GPS, the database information must be compared with that in the approach chart, including transitions, position and altitude of waypoints;
- IFR non-precision approach using GPS must be based on the approved procedures of the equipment database. It cannot be done based on data manually included.





GPS OPERATION (FOR AIRPLANES WITHOUT AUTOPILOT INSTALLED)





- Use of GPS for precision approach navigation mode is not allowed.
- Use of GPS is prohibited as primary means for navigation. GPS is approved as supplemental means for navigation;
- Use of GPS is prohibited for IFR in terminal area or in non-precision approach operations;
- If RAIM function becomes unavailable in en route phase of flight, position must be verified every 15 minutes using other IFR approved navigation system.



WAAS AND SBAS FUNCTIONALITIES:

The WAAS and SBAS functionalities are not available in Brazil and these functions are not tested or approved in Brazilian air space.

PLACARDS IN PORTUGUESE

Description	Placard	Place
Smoking ban		Instruments panel, right side
Engine oil level and specifications		On the engine nacelle, in correspondence of the engine oil reservoir access door
Fuel type and quantity		In correspondence of each fuel tank filler cap.
Baggage compartment capacity		Baggage compartment (vertical panel)

Description	Placard	Place
Ditching emergency exit: opening instructions		Ditching emergency exit handle: external side
Ditching emergency exit: opening instructions		Ditching emergency exit handle: internal side
Door locking system: bypass instructions		Main door and emergency exit: external side
Door locking system: bypass instructions		Main door and emergency exit: internal side

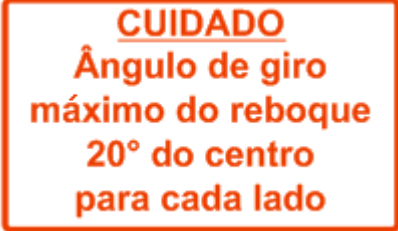
Description	Placard	Place
Main door: exit instructions		Main door, internal side
Emergency exit label		Emergency exit: internal and external side
Towing maximum turning angle		Nose landing gear front door

SUPPLEMENT NO. G9

CHINESE AIRCRAFT FLIGHT MANUAL SUPPLEMENT

(EASA APPROVED)

Record of Revisions

Rev	Revised page	Description of Revision	Tecnam Approval			EASA Approval or Under DOA Privileges
			DO	OoA	HDO	
0	-	First issue	P. Violetti	M. Oliva	L. Pascale	Third Country Validation

List of Effective Pages

Page	Revision	Page	Revision
G9-1	Rev 0	G9-7	Rev 0
G9-2	Rev 0	G9-8	Rev 0
G9-3	Rev 0	G9-9	Rev 0
G9-4	Rev 0	G9-10	Rev 0
G9-5	Rev 0	G9-11	Rev 0
G9-6	Rev 0	G9-12	Rev 0

TABLE OF CONTENTS

INTRODUCTION	4
GENERAL	4
LIMITATIONS	5
Approved fuel	5
Placards in Chinese	6
NORMAL OPERATIONS	10
Cold weather operations	10

INTRODUCTION

This supplement applies for Chinese registered aircraft.

GENERAL

Information contained herein complements the basic information in the EASA Approved Aircraft Flight Manual when the aircraft is registered in China.

For limitations, procedures, and performance information not contained in this Supplement, refer to the basic Aircraft Flight Manual.

LIMITATIONS

APPROVED FUEL

- MOGAS compliant with PRC National Standard GB17930-2006 - Octane Rating (RON) 97
- MOGAS ASTM D4814
- MOGAS EN 228 Super/Super plus (min. RON 95)
- AVGAS 100 LL (ASTM D910)







CAUTION

Prolonged use of Aviation Fuel Avgas 100LL results in greater wear of valve seats and greater combustion deposits inside cylinders due to higher lead content. It is therefore suggested to avoid using this type of fuel unless strictly necessary. Make reference to Rotax Maintenance Manual who provides dedicated checks due to the prolonged use of Avgas.

PLACARDS IN CHINESE

Description/Place	Placard	Chinese
Smoking ban. Instruments panel, right side		禁止吸烟
Engine oil level and specifications. On the engine nacelle, in correspondence of the engine oil reser- voir access door	 <p>USE ONLY OIL WITH API CLASSIFICATION SG OR HIGHER</p>	滑油箱 检查油位 滑油油位 最大 3Lt OK 最低 2Lt 滑油油位超出限制时，禁止飞行。 只允许使用API规定的或更高级别的滑油。
Fuel type and quanti- ty. In correspondence of each fuel tank filler cap.		GB17930 97号车用汽油-ASTM D4814车用汽油 航空汽油 100LL (ASTM D910) 97升 (25.6 U.S. 加仑) 合计可用容量
Baggage compartment capacity. Baggage compartment (vertical panel)		最大行李载荷 80kg/176磅 最大规定压强 0.9 kg/dm ² -19lbs/sqft 飞行前用行李网固定行李。

Description/Place	Placard	Chinese
Ditching emergency exit: opening instructions. Ditching emergency exit handle: internal side		水上迫降应急出口 1、旋转。 2、平稳向外推。
Ditching emergency exit: opening instructions. Ditching emergency exit handle: external side		水上迫降应急出口 1、旋转。 2、平稳向内拉。
Door locking system: by-pass instructions. Main door and emergency exit: external side		应急通道 1、按住红色扭。 2、用把手打开门。
Door locking system: by-pass instructions. Main door and emergency exit: internal side		应急出口 1、按住红色扭。 2、用把手打开门。

Description/Place	Placard	Chinese
<p>Main door: exit instructions.</p> <p>Main door, internal side</p>		<p>警告 打开门，向飞机前方撤离前，确认螺旋桨已经停止转动。</p>
<p>Emergency exit label.</p> <p>Emergency exit: internal and external side</p>	<p style="text-align: center;">EMERGENCY EXIT</p>	<p>应急出口</p>
<p>Maximum steering angle.</p> <p>Front of the aircraft.</p>		<p>注意 牵引最大转弯角度：中立两侧20度。</p>

INTENTIONALLY LEFT BLANK

NORMAL OPERATIONS

COLD WEATHER OPERATIONS

Engine cold weather operation

Refer to Rotax 912 Series Operators Manual, last issue, providing instructions for operating media (lubricant and coolant specifications) to be used in cold weather operation.

Parking

When the airplane is parked in cold weather conditions and it is expected to be soaked at temperatures below freezing, some precautions need to be taken.

Clear snow, slush, and ice in the parking area, or at least clear the area around the tires to prevent them from freezing to the ground. Apply plugs on Pitot and static ports.

The exposed airframe parts should be protected, especially the engines, the wheels, the blades and the gears against the snow or ice accumulation. Water and other freezable liquids should be removed from the airplane.

Standing water that could freeze should be removed from critical parts, as flaps and ailerons hinges, trim tabs hinges, drain points, LG doors, cabin doors etc.

With an ambient temperature of below -20°C , remove battery and store in a warm dry place; additionally in order to prevent a heavy discharge and to increase the battery life time, it is recommended to use an external power source for engine starting at temperatures lower than -15°C .

When wheel brakes come in contact with ice, slush, or snow with freezing conditions, the brake disk may freeze: park the aircraft with parking brake control knob in OFF position and ensure the aircraft is properly chocked and moored.

In any case, when the probability of ice, snow, or heavy frost is forecast, the use of a hangar is strongly recommended.

Preflight

Flight in expected and/or known icing conditions is forbidden.

An external inspection of the aircraft is performed before each flight, as prescribed on Section 4. For cold weather operations, the crew must focus on the check of following parts of airplane (free of snow/ice/standing water).

- control surfaces
- fuselage
- wings
- vertical and horizontal stabilator
- stall warning switch
- engine inlets
- engines draining points
- propeller blades
- LG doors
- Pitot, and static ports
- fuel tank vents

Tires show low pressure in cold weather: the required adjustments to inflation pressure should be performed on tires cooled to ambient temperature.

If the crew detects ice, anti icing products are not allowed. To remove ice, tow the aircraft in the hangar and operate with a soft brush or a humid cloth.



Removal of snow/ice accumulations is necessary prior to takeoff because they will seriously affect airplane performance. Aircraft with ice/snow accumulation are forbidden to flight.

If the aircraft must be operated in cold weather conditions within the range -25°C to -5°C, it is suggested to perform following procedure in order to speed up the engine warm-up:

- Tow the airplane in a warm hangar (at temperature more than -5°C).
- Let airplane temperature stabilize.
- Heat the cabin at a suitable value for crew comfort: an electrical fan heater can be used inside the cabin.
- Tow airplane outside and perform engine starting.

INTENTIONALLY LEFT BLANK

SUPPLEMENT NO. G11 – VLO/VLE INCREASE

RECORD OF REVISIONS

Rev	Revised page	Description of Revision	Tecnam Approval			EASA Approval Or Under DOA Privileges
			DO	OoA	HDO	
1	--	First issue	M. Landi	M. Oliva	L. Pascale	EASA approval 10041602

LOEP

Page	Revision
G11-1	Rev 1
G11-2	Rev 1
G11-3	Rev 1
G11-4	Rev 1
G11-5	Rev 1
G11-6	Rev 1

INTRODUCTION

This Supplement applies to aircraft equipped with Garmin G950 Integrated Flight Deck System (Design Change MOD 2006/002) and provides supplemental information to increase the V_{lo}/V_{le} when the Tecnam Service Bulletin SB 098-CS or Design Change MOD 2006/033 has been embodied on the airplane.

The information contained herein supersedes the basic Aircraft Flight Manual.

SECTION 2 - LIMITATIONS

SPEED LIMITATIONS

On the left side instrument panel, above on the left, it is placed the following placard reporting the speed limitations:

Maximum L.G. op. speed

$V_{LO} / V_{LE} = 122$ KIAS

INTENTIONALLY LEFT BLANK

SUPPLEMENT NO. G12 – SOUTH AFRICAN AFM

(SACAA APPROVED)

Record of Revisions

Rev	Revised page	Description of Revision	Tecnam Approval			EASA Approval Or Under DOA Privileges
			DO	OoA	HDO	
0	--	First issue	G. Paduano	M. Landi	M. Oliva	See Note (*)

Note (*): this Supplement has been originally issued on 2 May 2013, after EASA Third Country Validation process completion.

LOEP

Page	Revision	Page	Revision
G12-1	Rev 0	G12-5	Rev 0
G12-2	Rev 0	G12-6	Rev 0
G12-3	Rev 0	G12-7	Rev 0
G12-4	Rev 0	G12-8	Rev 0

TABLE OF CONTENTS

INTRODUCTION..... 4
LIMITATIONS..... 5
Maximum operating altitude 5
Inflight engine restart 5
GPS systems 6
GPS GNS 430 or GNS 530 operation (for airplanes with autopilot installed) 6
GPS GNS 430 or GNS 530 operation (for airplanes without autopilot installed) 6
WAAS and SBAS functionalities: 7

INTRODUCTION

This Supplement applies for South African registered aircraft

It contains supplemental information to the basic information approved in EASA aircraft Flight Manual when the aircraft is registered in South Africa.

For Limitations, procedures, and performance information not contained in this supplement, refer to the basic Aircraft Flight Manual.

The information contained herein supplements or supersedes the basic Aircraft Flight Manual or the Supplement G1, as applicable.

LIMITATIONS**MAXIMUM OPERATING ALTITUDE**

Maximum operating altitude is 14000 ft (4260 m) MSL.



At altitudes between 10 000 feet (3048 m) and 12 000 feet (3658 m) for longer than 120 minutes intended flight time, or above 12 000 feet, the aircraft shall not be operated unless the aircrew is provided with the supplemental oxygen as prescribed in Document SA-CATS 91 and such oxygen may be used continuously whenever these circumstances prevail.”

INFLIGHT ENGINE RESTART

The inflight engine restart procedure is reported on a placard (shown below) installed on the central console.

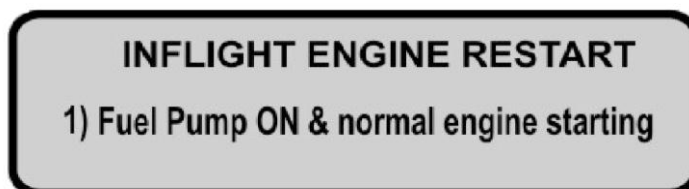

GPS SYSTEMS**GPS GNS 430 OR GNS 530 OPERATION (FOR AIRPLANES WITH AUTOPILOT INSTALLED)**

- Use of GPS for precision approach navigation mode is not allowed.
- Use of GPS is prohibited as primary means for navigation. GPS is approved as supplemental means for navigation;
- Navigation using of the GPS system as the source of information is limited to IFR en route, terminal area and non-precision approach mode;
- During IFR in terminal area or non-precision approach using GPS, autopilot or flight director must be coupled to GPS.
- If RAIM function becomes unavailable in “en route” phase of flight, position must be verified every 15 minutes using other IFR approved navigation system;
- During IFR in terminal area or non-precision approach using GPS, in case RAIM function becomes unavailable, the GPS navigation must be discontinued;
- Before an IFR non-precision approach using GPS, the availability of the RAIM function must be checked to the time and place predicted (RAIM prediction). If predicted the unavailability of the RAIM function, navigation must be planned with others approved navigation systems;
- Before a non-precision approach using GPS, the database information must be compared with that in the approach chart, including transitions, position and altitude of waypoints;
- IFR non-precision approach using GPS must be based on the approved procedures of the equipment database. It cannot be done based on data manually included.

GPS GNS 430 OR GNS 530 OPERATION (FOR AIRPLANES WITHOUT AUTOPILOT INSTALLED)

- Use of GPS for precision approach navigation mode is not allowed.
- Use of GPS is prohibited as primary means for navigation. GPS is approved as supplemental means for navigation;
- Use of GPS is prohibited for IFR in terminal area or in non-precision approach operations;
- If RAIM function becomes unavailable in en route phase of flight, position must be verified every 15 minutes using other IFR approved navigation system.

WAAS AND SBAS FUNCTIONALITIES

The WAAS and SBAS functionalities are not available in South Africa and these functions are not tested or approved in South African air space.

INTENTIONALLY LEFT BLANK

SUPPLEMENT NO. G13 – ALTERNATORS WITH 70 A INSTALLATION

Record of Revisions

Rev	Revised page	Description of Revision	Tecnam Approval			EASA Approval Or Under DOA Privileges
			DO	OoA	HDO	
0	-	See Note (*)				

List of Effective Pages

Page	Revision	Page	Revision
G13-1	Rev 0	G13-6	Rev 0
G13-2	Rev 0	G13-7	Rev 0
G13-3	Rev 0		
G13-4	Rev 0		
G13-5	Rev 0		

INTRODUCTION

This section contains supplemental information to operate, in a safe and efficient manner, the aircraft when 70A alternators are installed replacing the standard, 40A ones (Design Change MOD 2006/202).

The information contained herein supplements or supersedes the basic Aircraft Flight Manual: detailed instructions are provided to allow the owner for replacing the AFM pages containing information amended as per the Design Change in subject.

It is the owner's responsibility to replace the mentioned pages in the AFM in accordance with the instructions herein addressed section by section.

GENERAL

When 70A alternators are installed replacing the standard, 40A ones, the electrical system logic is not affected by any substantial change. Primary DC power is provided by two engine-driven alternators which, during normal operations, operate in parallel.

Each alternator is rated at 14,2-14,8 Vdc (through two external voltage regulators), 70 Amp and is provided with an automatic overvoltage device protecting the circuits and the electric components from an excessive voltage caused by alternator's failures.

The power rating of the each generator is such that if one generator fails the other one can still supply the airplane equipment to maintain flight safety.

SECTION 3 - EMERGENCY PROCEDURES

This section reports some procedures which replace the same procedure in the basic AFM. The procedures affected from the replacement of existing 40A alternators with 70A are the following:

- **Single alternator failure/overvoltage**
- **Both alternators failure**
- **Both alternators overvoltage**

SINGLE ALTERNATOR FAILURE / OVERVOLTAGE

Annunciation window	Alert window
L ALT FAIL	Lh Alternator

OR

R ALT FAIL	Rh Alternator
-------------------	---------------

1. FIELD LH (or RH) *OFF*
2. FIELD LH (or RH) *ON*

If the LH (or RH) ALT caution stays displayed

3. FIELD LH (or RH) *OFF*

NOTE

The battery and a single generator are able to supply the electrical power necessary for flight, but redundancy is lost.

Equipment will be lost accordingly to the following table:

LH Gen Bus	LH Avionic Bus	RH Avionic Bus	RH Gen Bus
Pitot Heat	DME	ADF	NAV Lights
Landing Light	Transponder	COM 2	Rudder Trim
Taxi Light	A/P	NAV 2	Stall Warning
	A/P Pitch Trim	MFD	
		AHRS/ADC	

4. *Land as soon as practicable*

BOTH ALTERNATORS FAILURE

Annunciation window	Alert window
L ALT FAIL	Lh Alternator
R ALT FAIL	Rh Alternator

In event of both L and R ALT FAIL caution alerts displayed:

1. FIELD LH and RH *BOTH OFF*
2. FIELD LH and RH *BOTH ON (one at a time)*

If the LH (or RH) ALT caution stays displayed

1. Verify good ammeter indications on restored alternator
2. Refer to Single alternator failure / overvoltage drill (Para 2.1)

If both LH and RH ALT cautions stay displayed

3. FIELD LH and RH *BOTH OFF*
4. CROSS BUS LH and RH *BOTH OFF*

If engine starting battery modification is applied

5. EMERG BATT switch ON
6. Land as soon as possible.

If engine starting battery modification is not applied

5. Land as soon as possible.

Equipment will be lost accordingly to the following table:

LH Gen Bus	LH Avionic Bus	RH Avionic Bus	RH Gen Bus
Pitot Heat	DME	ADF	NAV Lights
Landing Light	Transponder	COM 2	Rudder Trim
Taxi Light	A/P	NAV 2	Stall Warning
	A/P Pitch Trim	MFD	
		AHRS/ADC	

NOTE

The battery will supply electrical power for at least 30 minutes.

BOTH ALTERNATORS OVERVOLTAGE

Annunciation window	Alert window
L BUS VOLT HIGH	Lh overvoltage
R BUS VOLT HIGH	Rh overvoltage

In event of both L and R BUS VOLT HIGH warning alerts displayed:

1. FIELD LH and RH *BOTH OFF*
2. FIELD LH and RH *BOTH ON (one at a time)*

If the LH (or RH) BUS VOLT HIGH caution stays displayed

3. Verify good ammeter indications on restored alternator
4. Refer to Single alternator failure / overvoltage drill (Para 2.1)

If both LH and RH BUS VOLT HIGH warning stay displayed

3. CROSS BUS LH and RH *BOTH OFF*
4. FIELD LH and RH *BOTH OFF*
5. FIELD LH and RH *BOTH ON (one at a time)*

If LH (or RH) BUS VOLT HIGH warning stays displayed

6. Verify good ammeter indications on restored alternator
7. Switch CROSS BUS on the restored alternator side
8. Refer to Single alternator failure / overvoltage drill (Para 2.1)

If both LH and RH BUS VOLT HIGH warning stay displayed

7. FIELD LH and RH *BOTH OFF*

If engine starting battery modification is applied

7. EMERG BATT switch *ON*
8. **Land as soon as possible.**

If engine starting battery modification is not applied

8. **Land as soon as possible.**

Equipment will be lost accordingly to the following table:

LH Gen Bus	LH Avionic Bus	RH Avionic Bus	RH Gen Bus
Pitot Heat	DME	ADF	NAV Lights
Landing Light	Transponder	COM 2	Rudder Trim
Taxi Light	A/P	NAV 2	Stall Warning
	A/P Pitch Trim	MFD	
		AHRS/ADC	

NOTE

The battery can supply electrical power for at least 30 minutes.

INTENTIONALLY LEFT BLANK

SUPPLEMENT NO. G14 - SMP FOR DIGITAL CONFIGURATION

RECORD OF REVISIONS

Rev	Revised page	Description of Revision	Tecnam Approval			EASA Approval Or Under DOA Privileges
			DO	OoA	HDO	
0	-	First issue	D. Ronca	C. Caruso	M. Oliva	DOA Approval

LOEP

	Pages	Revision
Cover pages	G14 – 1 thru 23	<i>Rev. 0</i>
Section 2	SMP2 – 3	<i>Rev. 0</i>
Section 3	SSMP3 – 3 thru 5	<i>Rev. 0</i>
	SSMP3 – 7 thru 9	<i>Rev. 0</i>
	SSMP3 – 21	<i>Rev. 0</i>
	SSMP3 – 29	<i>Rev. 0</i>
	SSMP3 – 36 thru 40	<i>Rev. 0</i>
	SSMP3 – 49 thru 53	<i>Rev. 0</i>
Section 4	SSMP4 – 26 thru 27	<i>Rev. 0</i>
Section 7	SSMP7 – 41	<i>Rev. 0</i>
	SSMP7 – 44 thru 47	<i>Rev. 0</i>

INTRODUCTION

This section contains supplemental information to operate, in a safe and efficient manner, the aircraft when equipped with Garmin G950 Integrated Flight Deck System (Design Change MOD 2006/002) and with Special Mission Platform. The Special Mission Platform refers to the following design changes:

- MOD2006/046 - Power supply from built-in generators
- MOD2006/202 - Replacement of existing 40A alternators with 70A
- MOD2006/204 - Installation of converter box

For the two first design changes the supplements (n° I 28 and G13) are already approved by EASA and in this supplement we report the same information for reference.

The Rotax engine built-in generators, one for each engine, feed two bus bars made available for end user equipment, when the design change 2006/046 is installed.

When 70A alternators are installed replacing the standard, 40A ones, the electrical system logic is not affected by any substantial change. Primary DC power is provided by two engine-driven alternators which, during normal operations, operate in parallel.

Each alternator is rated at 14,2-14,8 Vdc (through two external, first fuselage frame installed voltage regulators), 70 Amp and is provided with an automatic overvoltage device protecting the circuits and the electric components from an excessive voltage caused by alternator's failures.

The power rating of the each generator is such that if one generator fails the other one can still supply the airplane equipment to maintain flight safety.

The information contained herein supplements or supersedes the basic Aircraft Flight Manual or the Supplement G1, as applicable: detailed instructions are provided to allow the owner for replacing the Basic AFM/Supplement G1 pages containing information amended as per the Design Changes in subject.

NOTE

Usually, the Special Mission Platform P2006T is also equipped with holes in the cabin and/or tailcone, ready for third parties sensor's integration. While the Tecnam intent is to offer a platform ready for sensors' integration, it is end-user responsibility to receive the approval from authority for each equipment installation.

It is the owner's/operator's responsibility to replace the mentioned pages in the AFM in accordance with the instructions herein addressed section by section.

INTENTIONALLY LEFT BLANK

Supplement G14: pages replacement instructions

SECTION 1 – GENERAL

Apply following instruction:

See Basic AFM - Section 1

INTENTIONALLY LEFT BLANK

Supplement G14: pages replacement instructions

SECTION 2 – LIMITATIONS

Apply following pages replacement procedure:

Supplement G14 - LIMITATIONS page		Basic AFM Section 2 page
SMP2 – 3	REPLACES	Page 2 – 3 of Basic AFM, Section 2

INTENTIONALLY LEFT BLANK

1. INTRODUCTION

Section 2 includes operating limitations, instrument markings and basic placards necessary for safe operation of *P2006T* aircraft, its engines and standard systems and equipment.

LH and RH AUX FIELDS, enabling the converter box operations for Special Mission purposes, should be kept OFF during take-off, climb, landing and any abnormal procedure that affects electrical generating system (including single engine operation):

During Take-off, Climb, Landing and Single Engine Operations:

LH and RH AUX FIELD switches

BOTH OFF

NOTE

This limitation only applies when both 70Amp alternators and converter box are installed.

NOTE

Safety provisions, as following described, automatically disengage the LH and RH AUX FIELDS in case of one main field malfunction (i.e. for OEI). Also, if only one AUX FIELD switch is ON, the converter box is not powered.

INTENTIONALLY LEFT BLANK

Supplement G14: pages replacement instructions

SECTION 3 – EMERGENCY PROCEDURES

Apply following pages replacement procedure:

Supplement G14 - EMERGENCY PROCEDURES page		Supplement G1 Section 3 page
SSMP3 – 3 thru 5	REPLACE	Page S3 – 3 thru 5 of Supplement G1, Section 3
SSMP3 – 7 thru 9	REPLACE	Page S3 – 8 thru 11 of Supplement G1, Section 3
SSMP3 – 21	REPLACES	Page S3 – 21 of Supplement G1, Section 3
SSMP3 – 29	REPLACES	Page S3 – 29 of Supplement G1, Section 3
SSMP3 – 36 thru 40	REPLACE	Page S3 – 36 thru 40 of Supplement G1, Section 3
SSMP3 – 49 thru 53	REPLACE	Page S3 – 49 thru 53 of Supplement G1, Section 3

INTENTIONALLY LEFT BLANK

1. INTRODUCTION

Section 3 includes checklists and detailed procedures for coping with various types of emergency conditions that could arise after a system failure.

The procedures affected from installation of the Special Mission Platform are the following:

- **Single alternator failure / overvoltage**
- **Both alternators failure**
- **Both alternators overvoltage**
- **Engine securing**
- **Total electrical failure**
- **Inflight engine restart**
- **Engine failure during takeoff run**
- **Engine failure during climb**
- **Engine failure in flight**
- **Engine fire on the ground**
- **Engine fire during takeoff run**
- **Engine fire in flight**
- **Electrical smoke in cabin on the ground**
- **Electrical smoke in cabin during flight**

The main difference regarding aircraft systems, compared with the basic AFM, is the presence of the Power supply from built-in generators, Alternators with 70A and Converter Box. The powering and disconnection of converter box is very simple and, in most of abnormal cases, is automatically managed by relays and safety provisions.

The converter box (following described in Section 7) is managed by the pilot only via two switches, located in the bottom LH side of pilot seat on a single panel provided by: two switches, two breakers and two indicating lamps.

Only when pilot selects BOTH switches ON (right and left AUX) and both alternators are operative the system allows a surplus of power generated by the engines and alternators to flow into 4x converters and, then, into mission equipment, when installed.

The health status of converters inside the box (located into the baggage compartment) is monitored by mission operator, via 4x failure indicating lamps. Following the key concepts when managing converter boxes:

1. Mission Power Switches: they enable the converter box ONLY when BOTH are set to ON;
2. Converter box power: enabled only if both LH and RH main alternators are generating power;
3. Converter box: automatically switches OFF in case LH or RH main alternators is faulty / not generating;
4. Converter box: automatically switches OFF in case LH or RH mission switch is set to OFF;

5. Failure lamp: when illuminated, indicates that the correspondent converter is not working properly and needs to be replaced if the maximum available power from converter box is needed. When all converters are working properly, the system is capable to output 40A@28V. If one converter fails, 12A@28V are lost. For this reason, the end-user mission can continue if the equipment demand is less than 25/28A. On the contrary, the converter needs to be replaced.

Before operating the aircraft, the pilot/operator should become thoroughly familiar with this manual and, in particular, with this Section. Further on a continued and appropriate training and self study should be done.

Two types of emergency procedures are hereby given.

- a. “BOLD FACES” which must be known by heart by the pilot and executed, in the correct and complete sequence, immediately after the failure is detected and confirmed.

These procedures characters are boxed and highlighted:

1.1 ENGINE FAILURE DURING TAKEOFF RUN

BEFORE ROTATION: ABORT TAKE OFF

- | | | |
|----|-----------------------|------------------------------------|
| 1. | Throttle Lever | <i>BOTH IDLE</i> |
| 2. | Rudder | <i>Keep heading control</i> |
| 3. | -- | |
| 4. | -- | |

- b. “other procedures” which should be well theoretically known and mastered, but that can be executed entering and following step by step the AFM current section appropriate checklist.

Additionally operating the aircraft, the pilot should become thoroughly familiar with the Garmin G950 Pilot’s Guide for Tecnam P2006T (P/N 190-01146-XX) – last issue - and, in particular, with the present AFM Section.



CAUTION

Garmin G950 Pilot’s Guide for Tecnam P2006T (P/N 190-01146-XX) – last issue - must be carried onboard the airplane at all times.



WARNING

Garmin G950 has a very high degree of functional integrity. However, the pilot must recognize that providing monitoring and/or self-test capability for all conceivable system failures is not practical. Although unlikely, it may be possible for erroneous operation to occur without a fault indication shown by the G950. It is thus the responsibility of the pilot to detect such an occurrence by means of crosschecking with all redundant or correlated information available in the cockpit.

In any case, as a failure or abnormal behaviour is detected pilots should act as follows:

- 1. Keep self-control and maintain aircraft flight attitude and parameters*
- 2. Analyse the situation identifying, if required, the area for a possible emergency landing*
- 3. Apply the pertinent procedure*
- 4. Inform the Air Traffic Control as applicable*

NOTE

For the safe conduct of later flights, any anomaly and/or failure must be communicated to the National Authorities in charge, in order to put the aircraft in a fully operational and safe condition.

NOTE

In this Chapter, following definitions apply:

Land as soon as possible: land without delay at the nearest suitable area at which a safe approach and landing is assured.

Land as soon as practical: land at the nearest approved landing area where suitable repairs can be made.

2.1. SINGLE ALTERNATOR FAILURE / OVERVOLTAGE

Annunciation window	Alert window
L ALT FAIL	Lh Alternator
OR	
R ALT FAIL	Rh Alternator

1. FIELD LH (or RH) *OFF*
2. LH and RH AUX FIELD switch *BOTH OFF*
3. FIELD LH (or RH) *ON*

If the LH (or RH) ALT caution stays displayed

1. FIELD LH (or RH) *OFF*

If the LH (or RH) GENERATOR caution persists displayed

1. CROSS BUS LH (or RH) *OFF*
2. **Land as soon as practical.**

NOTE

The battery and a single generator are able to supply the electrical power necessary for the entire mission, but redundancy is lost.

2.2 BOTH ALTERNATORS FAILURE

Annunciation window	Alert window
L ALT FAIL R ALT FAIL	Lh Alternator
	Rh Alternator

In event of both L and R ALT FAIL caution alerts displayed:

1. FIELD LH and RH *BOTH OFF*
2. LH and RH AUX FIELD switch *BOTH OFF*
3. FIELD LH and RH *BOTH ON*

If both LH and RH ALT cautions stay displayed

1. FIELD LH and RH *BOTH OFF*
2. CROSS BUS LH and RH *BOTH OFF*

If engine starting battery modification is applied

1. EMERG BATT switch ON
2. Land as soon as possible.

If engine starting battery modification is not applied

1. Land as soon as possible.

NOTE

The battery can supply electrical power for at least 30 minutes.

2.3 BOTH ALTERNATORS OVERVOLTAGE

Annunciation window	Alert window
L BUS VOLT HIGH	Lh overvoltage
R BUS VOLT HIGH	Rh overvoltage

In event of both L and R BUS VOLT HIGH warning alerts displayed:

1. FIELD LH and RH *BOTH OFF*
2. LH and RH AUX FIELD switch *BOTH OFF*
3. FIELD LH and RH *BOTH ON (one at a time)*

if LH (or RH) OVERVOLT warning stays displayed

1. FIELD LH (or RH) *OFF*

if both LH and RH OVERVOLT warning stay displayed

1. CROSS BUS LH and RH *BOTH OFF*
2. FIELD LH and RH *BOTH OFF*
3. FIELD LH and RH *BOTH ON (one at a time)*

If LH (or RH) OVERVOLT warningt stays displayed

1. FIELD LH (or RH) *OFF*
2. CROSS BUS LH (or RH) *ON*

If both LH and RH OVERVOLT warning stay displayed

1. FIELD LH and RH *BOTH OFF*
2. CROSS BUS LH and RH *BOTH OFF*

If engine starting battery modification is applied

1. EMERG BATT switch *ON*
2. Land as soon as possible.

If engine starting battery modification is not applied

1. Land as soon as possible.

NOTE

The battery can supply electrical power for at least 30 minutes.

3. ENGINE SECURING

Following procedure is applicable to shut-down one engine in flight:

- | | |
|-------------------------------|-----------------|
| 1. Throttle Lever | IDLE |
| 2. Ignition | BOTH OFF |
| 3. Propeller Lever | FEATHER |
| 4. Fuel Selector | OFF |
| 5. Electrical fuel pump | OFF |
| 6. LH and RH AUX FIELD switch | BOTH OFF |

NOTE

If necessary, this procedure is applicable to both engines. When both engines are secured, both CROSS BUS switches must be set to OFF.

After securing engine(s), after analysing situation, refer immediately to following procedures:

ENGINE FAILURE IN FLIGHT:	see Para. 6.5
SINGLE GENERATOR FAILURE:	see Para. 2.1
or BOTH GENERATOR FAILURE:	see Para. 2.2
INFLIGHT ENGINE RESTART:	see Para. 6.2
ONE ENGINE INOPERATIVE LANDING:	see Para. 6.6
or LANDING WITHOUT ENGINE POWER:	see Para. 10.1

5. OTHER EMERGENCIES

5.1 EMERGENCY DESCENT



CAUTION

Descent with airspeed at VLE, idle power and gear down will provide high descent rates and pitch attitudes up to -15°.

Anticipate altitude capture and return to level flight during emergency descent in order to assure a safe and smooth recovery from maneuver.

- | | |
|-----------------|----------------------|
| 1. Power levers | <i>IDLE</i> |
| 2. Flaps | <i>UP</i> |
| 3. IAS | <i>below VLO/VLE</i> |
| 4. Landing gear | <i>DOWN</i> |
| 5. Airspeed | <i>Up to VLE</i> |

5.2 TOTAL ELECTRICAL FAILURE

In case of electrical system overall failure, apply following procedure:

- | | |
|--------------------------------------|-----------------|
| 1. Emergency light | <i>ON</i> |
| 2. Standby attitude indicator switch | <i>ON</i> |
| 3. MASTER SWITCH | <i>OFF</i> |
| 4. FIELD LH and RH | <i>BOTH OFF</i> |
| 5. LH and RH AUX FIELD switch | <i>BOTH OFF</i> |
| 6. MASTER SWITCH | <i>ON</i> |
| 7. FIELD LH and RH | <i>BOTH ON</i> |

If failure persists

- | | |
|--|--|
| 9. EMERG BATT switch | <i>ON (if engine starting battery installed)</i> |
| 10. Land as soon as possible applying <i>emergency landing gear extension</i> procedure (see Para. 7.1) | |



WARNING

An electrical system overall failure prevents flaps operation: landing distance without flaps increases of about 25%.



CAUTION

A fully charged battery can supply electrical power for at least 30 minutes.

6.2 INFLIGHT ENGINE RESTART

After:



WARNING

- mechanical engine seizure;
- fire;
- major propeller damage

engine restart is not recommended.

- | | |
|------------------------------------|--|
| 1. Carburettor heat | <i>ON if required</i> |
| 2. Electrical fuel pump | <i>ON</i> |
| 3. Fuel quantity indicator | <i>CHECK</i> |
| 4. Fuel Selector | <i>CHECK (Crossfeed if required)</i> |
| 5. FIELD | <i>OFF</i> |
| 6. LH and RH AUX FIELD switch | <i>BOTH OFF</i> |
| 7. Ignition | <i>BOTH ON</i> |
| 8. Operating engine Throttle Lever | <i>SET as practical</i> |
| 9. Stopped engine Throttle Lever | <i>IDLE</i> |
| 10. Stopped engine Propeller Lever | <i>FULL FORWARD</i> |
| 11. Start push-button | <i>PUSH</i> |
| 12. Propeller Lever | <i>SET at desired rpm</i> |
| 13. FIELD | <i>ON (check for positive ammeter)</i> |
| 14. Engine throttle levers | <i>SET as required</i> |

If engine restart is unsuccessful

- | | |
|-------------------------------------|---|
| 15. EMERG BATT switch | <i>ON (if starting battery installed)</i> |
| 16. Repeat engine restart procedure | |



CAUTION

After engine restart, if practical, moderate propeller rpm and throttle increase to allow OIL and CHT/CT temperatures for stabilizing in the green arcs.

NOTE

If the fuel quantity in the tank which feeds the stopped engine is low, select the opposite side fuel tank by means of the fuel selector.

If engine restart is still unsuccessful:

- | | |
|---|---|
| 17. Affected engine | <i>SECURE (see engine securing procedure Para. 3)</i> |
| 18. Land as soon as possible applying one engine inoperative landing procedure. See Para. 6.6 | |

6.3 ENGINE FAILURE DURING TAKEOFF RUN

BEFORE ROTATION: ABORT TAKE OFF

- | | |
|--------------------------|------------------------------------|
| 1. Throttle Lever | <i>BOTH IDLE</i> |
| 2. Rudder | <i>Keep heading control</i> |
| 3. Brakes | <i>As required</i> |

When safely stopped:

- | | |
|---------------------------------------|-----------------|
| 4. Failed Engine Ignition | BOTH OFF |
| 5. Failed Engine Field | OFF |
| 6. LH and RH AUX FIELD switch | BOTH OFF |
| 7. Failed Engine Electrical fuel pump | OFF |

IF THE DECISION IS TAKEN TO CONTINUE THE TAKEOFF:

A take-off abort should always be preferred if a safe stop can be performed on ground.

A suggested "GO-NO-GO" criteria is: abort take-off until LG is still down and locked.

Once airborne accelerate to Blue Line Speed (V_{YSE}) before commanding LG retraction.

Take-off planning should take into account that high density altitude and aircraft mass may result in OEI negative climb rate.

V_{YSE} with flap up shall be flown in order to achieve best possible rate of climb after landing gear retraction and engine feathering.



WARNING

- | | |
|---|---|
| 1. Operating engine Throttle Lever | <i>FULL POWER</i> |
| 2. Operating engine Propeller Lever | <i>FULL FORWARD</i> |
| 3. Heading | <i>Keep control using rudder and ailerons</i> |
| 4. Attitude | <i>Reduce as appropriate to keep airspeed over 62 KIAS</i> |
| 5. <u>Inoperative engine</u> Propeller Lever | <i>FEATHER</i> |
| 6. Landing gear control lever | <i>UP</i> |
| 7. Airspeed | <i>V_{XSE}/V_{YSE} as required</i> |
| 8. Flaps | <i>0°</i> |
| 9. LH and RH AUX FIELD switch | <i>BOTH OFF</i> |

6.4 ENGINE FAILURE DURING CLIMB

- | | |
|---------------------|--|
| 1. Autopilot | OFF |
| 2. Heading | <i>Keep control using rudder and ailerons</i> |
| 3. Attitude | <i>Reduce as appropriate to keep airspeed over 62 KIAS</i> |
-
- | | |
|--|---------------------------|
| 4. Operating engine Throttle Lever | <i>FULL THROTTLE</i> |
| 5. Operating engine Propeller Lever | <i>FULL FORWARD</i> |
| 6. Operative engine Electrical fuel pump | <i>Check ON</i> |
| 7. LH and RH AUX FIELD switch | <i>BOTH OFF</i> |
| 8. <u>Inoperative engine</u> Propeller Lever | <i>FEATHER</i> |
| 9. <u>Inoperative engine</u> | Confirm and <i>SECURE</i> |

If engine restart is possible:

10. Apply INFLIGHT ENGINE RESTART procedure *see Para 6.2*

If engine restart is unsuccessful or it is not recommended:

11. **Land as soon as possible**
12. One engine inoperative landing procedure. *see Para. 6.6*



WARNING

Following a mechanical engine seizure, fire or a major propeller damage engine restart is not recommended.



WARNING

Continuation of flight to a safe landing runway must be planned taking into account maximum operating ceiling in OEI condition. Refer to Section 5 Para 1, "One-engine rate of climb".

6.5 ENGINE FAILURE IN FLIGHT

- | | |
|--------------|--|
| 1. Autopilot | <i>OFF</i> |
| 2. Heading | <i>Keep control using rudder and ailerons</i> |
| 3. Attitude | <i>Adjust as appropriate to keep airspeed over 62 KIAS</i> |

- | | |
|--|--|
| 4. LH and RH AUX FIELD switch | <i>BOTH OFF</i> |
| 5. Operating engine | <i>Monitor engine instruments</i> |
| 6. Operative engine Electrical fuel pump | <i>Check ON</i> |
| 7. Operating engine Fuel Selector | <i>Check correct feeding
(crossfeed if needed)</i> |

If engine restart is possible:

8. Apply INFLIGHT ENGINE RESTART procedure *see Para 6.2*

If engine restart is unsuccessful or it is not recommended:

9. Land as soon as possible
10. One engine inoperative landing procedure. *see Para. 6.6*



WARNING

Following a mechanical engine seizure, fire or a major propeller damage engine restart is not recommended.



WARNING

Continuation of flight to a safe landing runway must be planned taking into account maximum operating ceiling in OEI condition. Refer to Section 5 Para 12. Rate of climb with One Engine Inoperative.

8 SMOKE AND FIRE OCCURRENCE

8.1 ENGINE FIRE ON THE GROUND

- | | |
|-------------------------------|------------------------------|
| 1. Fuel Selectors | <i>BOTH OFF</i> |
| 2. Ignitions | <i>ALL OFF</i> |
| 3. LH and RH AUX FIELD switch | <i>BOTH OFF</i> |
| 4. Electrical fuel pumps | <i>BOTH OFF</i> |
| 5. Cabin heat and defrost | <i>OFF</i> |
| 6. MASTER SWITCH | <i>OFF</i> |
| 7. Parking Brake | <i>ENGAGED</i> |
| 8. Aircraft Evacuation | carry out immediately |



Consider use of ditching emergency exit to escape in case pilot or passenger doors are blocked, watch for engine hot parts, fuel, hydraulic fluid or oil spills. Leave aircraft in upwind direction.

8.2 ENGINE FIRE DURING TAKEOFF RUN

BEFORE ROTATION: ABORT TAKE OFF

- | | |
|-------------------|-----------------------------|
| 1. Throttle Lever | BOTH IDLE |
| 2. Rudder | <i>Keep heading control</i> |
| 3. Brakes | <i>As required</i> |

With aircraft under control

- | | |
|-------------------------------|------------------------------|
| 4. Fuel Selector | BOTH OFF |
| 5. Ignitions | ALL OFF |
| 6. LH and RH AUX FIELD switch | BOTH OFF |
| 7. Electrical fuel pump | BOTH OFF |
| 8. Cabin heat and defrost | OFF |
| 9. MASTER SWITCH | OFF |
| 10. Parking Brake | ENGAGED |
| 11. Aircraft Evacuation | <i>carry out immediately</i> |

**WARNING**

Consider use of ditching emergency exit to escape in case pilot or passenger doors are blocked, watch for engine hot parts, fuel, hydraulic fluid or oil spills. Leave aircraft in upwind direction.

IF THE DECISION IS TAKEN TO CONTINUE THE TAKEOFF:

A take-off abort should always be preferred if a safe stop can be performed on ground.

A suggested "GO-NO-GO" criteria is: abort take-off until LG is still down and locked.

**WARNING**

Once airborne accelerate to Blue Line Speed (V_{YSE}) before commanding LG retraction.

Take-off planning should take into account that high density altitude and aircraft mass may result in OEI negative climb rate.

V_{YSE} with flap up shall be flown in order to achieve best possible rate of climb after landing gear retraction and engine feathering.

- | | |
|--|--|
| 1. Operating engine Throttle Lever | FULL POWER |
| 2. Operating engine Propeller Lever | FULL FORWARD |
| 3. Heading | <i>Keep control using rudder and ailerons</i> |
| 4. Attitude | <i>Reduce as appropriate to keep airspeed over 62 KIAS</i> |
| 5. <u>Fire affected engine</u> Propeller Lever | FEATHER |
| 6. Landing gear control lever | UP |
| 7. Airspeed | V_{XSE}/V_{YSE} <i>as required</i> |
| 8. Flaps | 0° |

At safe altitude

- | | | |
|-----|--|-----------------------------|
| 9. | LH and RH AUX FIELD switch | <i>BOTH OFF</i> |
| 10. | Cabin heat and defrost | <i>BOTH OFF</i> |
| 11. | <u>Fire affected engine</u> Fuel Selector | <i>Confirm and OFF</i> |
| 12. | <u>Fire affected engine</u> Ignitions | <i>Confirm and BOTH OFF</i> |
| 13. | <u>Fire affected engine</u> Electrical fuel pump | <i>Confirm and OFF</i> |
| 14. | <u>Fire affected engine</u> FIELD | <i>OFF</i> |
| 15. | Land as soon as possible applying <i>one engine inoperative landing</i> procedure.
See Para. 6.6 | |

8.3 ENGINE FIRE IN FLIGHT

- | | |
|--|--|
| 1. Cabin heat and defrost | <i>BOTH OFF</i> |
| 2. LH and RH AUX FIELD switch | <i>BOTH OFF</i> |
| 3. Autopilot | <i>OFF</i> |
| 4. <u>Fire affected engine</u> Fuel Selector | <i>Confirm and OFF</i> |
| 5. <u>Fire affected engine</u> Ignition | <i>Confirm and BOTH OFF</i> |
| 6. <u>Fire affected engine</u> Throttle Lever | <i>Confirm and FULL FORWARD</i> |
| 7. <u>Fire affected engine</u> Propeller Lever | <i>Confirm and FEATHER</i> |
| 8. <u>Fire affected engine</u> Electrical fuel pump | <i>OFF</i> |
| 9. Heading | <i>Keep control using rudder and ailerons</i> |
| 10. Attitude | <i>Adjust as appropriate to keep airspeed over 62 KIAS</i> |
| 11. <u>Fire affected engine</u> Field | <i>OFF</i> |
| 12. Cabin ventilation | <i>OPEN</i> |
| 13. Land as soon as possible applying <i>one engine inoperative landing procedure.</i> | |
- See Para. 6.6

8.4 ELECTRICAL SMOKE IN CABIN ON THE GROUND

- | | |
|-------------------------------|------------------------------|
| 1. MASTER SWITCH | <i>OFF</i> |
| 2. Cabin heat and defrost | <i>OFF</i> |
| 3. LH and RH AUX FIELD switch | <i>BOTH OFF</i> |
| 4. Throttle Lever | <i>BOTH IDLE</i> |
| 5. Ignitions | <i>ALL OFF</i> |
| 6. Fuel Selector | <i>BOTH OFF</i> |
| 7. Parking Brake | <i>ENGAGED</i> |
| 8. Aircraft Evacuation | <i>carry out immediately</i> |



Consider use of ditching emergency exit to escape in case pilot or passenger doors are blocked, watch for engine hot parts, fuel, hydraulic fluid or oil spills. Leave aircraft in upwind direction.

8.5 ELECTRICAL SMOKE IN CABIN DURING FLIGHT

- | | |
|--|-------------|
| 1. Cabin ventilation | <i>OPEN</i> |
| 2. Emergency light | <i>ON</i> |
| 3. Standby attitude indicator switch | <i>ON</i> |
| 4. Gain VMC conditions as soon as possible | |

In case of cockpit fire:

- | | |
|----------------------|----------------------------------|
| 5. Fire extinguisher | <i>use toward base of flames</i> |
|----------------------|----------------------------------|



CAUTION

A tripped circuit breaker should not be reset.

If smoke persists, shed electrical supply in order to isolate faulty source by:

- | | |
|-------------------------------|-----------------|
| 6. FIELD LH and RH | <i>OFF</i> |
| 7. LH and RH AUX FIELD switch | <i>BOTH OFF</i> |
| 8. AVIONICS LH and RH | <i>OFF</i> |
| 9. CROSS BUS LH and RH | <i>BOTH OFF</i> |



CAUTION

A fully charged battery can supply electrical power for at least 30 minutes.

If faulty source is found:

10. It may be possible to restore non faulty power sources (one at a time)

If smoke persists:

Before total electrical system shutdown consider gaining VMC condition, at night set personal emergency light on.

Only emergency light and emergency ADI will be electrically powered.

All radio COM and NAV, Landing Gear lever (normal mode) and indication lights, electrical trims and flaps will be unserviceable.



WARNING

- | | |
|------------------------------|------------|
| 11. MASTER SWITCH | <i>OFF</i> |
| 12. Land as soon as possible | |

INTENTIONALLY LEFT BLANK

Supplement G14: pages replacement instructions

SECTION 4 – NORMAL PROCEDURES

Apply following pages replacement procedure:

Supplement G14 - NORMAL PROCEDURES page		Supplement S1 Section 4 page
SSMP4 – 26 thru 27	REPLACE	Page S4 – 26 thru 27 of Supplement G1, Section 4

INTENTIONALLY LEFT BLANK

3.10 CRUISE

- 1 LH and RH Propeller Lever *SET to 1900-2250 RPM*

**CAUTION**

Throttles MAP decrease should be made before propeller speed reduction below 2200 RPM, as, contrariwise, Propeller Lever increase RPM should be set before engine Throttle Levers are advanced.

- 2 Engine parameters check (LH and RH)

- Oil temperature: $90^{\circ} \div 110^{\circ} \text{ C}$.
- CHT: $90^{\circ} \div 110^{\circ} \text{ C}$
- Oil pressure: $2 - 5 \text{ bar}$.
- Fuel pressure: $2.2 - 5.8 \text{ psi}$
 $*2.2 - 7.26 \text{ psi (0.15 - 0.50 bar)}$

**applicable for fuel pump part no.893110 and no.893114*

- 3 Carburettor heat as needed (*see also instructions addressed on Section 3, Para. 7.4*)

**WARNING**

Deselect and do not use Auto Pilot if possible icing condition area is inadvertently entered.

- 4 Fuel balance and crossfeed *check as necessary*

3.10.1 CONVERTER BOX TURN ON

- 1 LH and RH AUX FIELD *ON*
- 2 Converter Box *Check enabled (no fail lamps)*
- 3 Mission systems *Use as required*

3.10.2 CONVERTER BOX TURN OFF

- 1 Mission systems *Shut down as necessary*
- 2 LH and RH AUX FIELD *OFF*
- 3 Green lamps on switch panel *Check OFF*

3.11 TURBULENT AIR OPERATION

In keeping with good operating practice used in all aircraft, it is recommended that when turbulent air is encountered or expected, the airspeed be reduced to maneuvering speed to reduce the structural loads caused by gusts and to allow for inadvertent speed build-ups, which may occur as a result of the turbulence or of distractions caused by the conditions.

3.12 DESCENT AND APPROACH

- | | | |
|---|-------------------|---------------------------------------|
| 1 | Propellers | <i>Set to Max Continuous 2250 RPM</i> |
| 2 | Carburettors heat | <i>As required</i> |
| 3 | Altimeter setting | <i>QNH set and crosscheck</i> |

3.13 BEFORE LANDING

- | 1 | Rear passengers seats | <i>Seats set at full aft and lower position</i> | | | | |
|--------------------------------|---|---|--------------|--------------------------------|--------------------------------|-------------------------------|
| 2 | LH and RH Electrical Fuel pump | <i>BOTH ON</i> | | | | |
| 3 | On downwind leg: | | | | | |
| | <table border="1" style="width: 100%; border-collapse: collapse;"> <thead> <tr> <th style="width: 50%; padding: 5px;">MTOW 1180kg</th> <th style="width: 50%; padding: 5px;">MTOW 1230 kg</th> </tr> </thead> <tbody> <tr> <td style="text-align: center; padding: 5px;"><i>V_{FE}= 119KIAS</i></td> <td style="text-align: center; padding: 5px;"><i>V_{FE}=122KIAS</i></td> </tr> </tbody> </table> | MTOW 1180kg | MTOW 1230 kg | <i>V_{FE}= 119KIAS</i> | <i>V_{FE}=122KIAS</i> | <i>Flaps T/O</i> |
| MTOW 1180kg | MTOW 1230 kg | | | | | |
| <i>V_{FE}= 119KIAS</i> | <i>V_{FE}=122KIAS</i> | | | | | |
| 4 | Speed below applicable VLO/VLE | <i>Landing gear control knob - DOWN –
Check green lights ON</i> | | | | |
| 5 | Carburettors heat | <i>CHECK OFF</i> | | | | |
| 6 | LH and RH Propeller Lever | <i>FULL FORWARD</i> | | | | |
| 7 | On final leg: speed below 93 KIAS | <i>Flaps FULL</i> | | | | |
| 8 | Final Approach Speed | <table border="1" style="width: 100%; border-collapse: collapse;"> <thead> <tr> <th style="width: 50%; padding: 5px;">MTOW 1180kg</th> <th style="width: 50%; padding: 5px;">MTOW 1230 kg</th> </tr> </thead> <tbody> <tr> <td style="text-align: center; padding: 5px;"><i>V_{APP}= 70KIAS</i></td> <td style="text-align: center; padding: 5px;"><i>V_{APP}=71KIAS</i></td> </tr> </tbody> </table> | MTOW 1180kg | MTOW 1230 kg | <i>V_{APP}= 70KIAS</i> | <i>V_{APP}=71KIAS</i> |
| MTOW 1180kg | MTOW 1230 kg | | | | | |
| <i>V_{APP}= 70KIAS</i> | <i>V_{APP}=71KIAS</i> | | | | | |
| 9 | Landing and taxi light | <i>ON</i> | | | | |
| 10 | Touchdown speed | <i>65 KIAS</i> | | | | |

Supplement G14: pages replacement instructions

SECTION 5 – PERFORMANCE

Apply following instruction:

See Basic AFM - Section 5

NOTE

Usually, the Special Mission Platform P2006T is also equipped with holes in the cabin and/or tailcone, ready for third parties sensor's integration. While the Tecnam intent is to offer a platform ready for sensors' integration, it is end-user responsibility to receive the approval from authority for each equipment installation, including the supplement of Section 5, should the equipment affect it (i.e. protruding cameras).

INTENTIONALLY LEFT BLANK

Supplement G14: pages replacement instructions

SECTION 6 – WEIGHT AND BALANCE

Apply following instruction:

See **Basic AFM - Section 6**

INTENTIONALLY LEFT BLANK

Supplement G14: pages replacement instructions

SECTION 7 – AIRFRAME AND SYSTEMS DESCRIPTION

Apply following pages replacement procedure:

Supplement G14 - AIRFRAME AND SYSTEMS DESCRIPTION page		Supplement S1 Section 7 page
SSMP7 – 41	REPLACES	Page S7 – 41 of Supplement G1, Section 7
SSMP7 – 44 thru 47	REPLACE	Page S7 – 44 thru 46 of Supplement G1, Section 7

INTENTIONALLY LEFT BLANK

18. ELECTRICAL SYSTEMS

Primary DC power is provided by two engine-driven alternators which, during normal operations, operate in parallel.

Each alternator is rated at 14,2-14,8 VDC, 70 Amp, and it is fitted with an external voltage regulator, which acts to maintain a constant output voltage, and with an automatic overvoltage device protecting the circuits and the electric components from an excessive voltage caused by alternator failures.

The power rating of the each alternator is such that if one alternator fails the other one can still supply the airplane equipment to maintain flight safety.

Secondary DC power is provided by a battery (lead type - Gill Teledyne G35, 12 V, 23-Ah in 1h run time) and an external DC power source can be connected to the aircraft DC distribution system.

On the instruments panel, right side, it is installed a voltmeter/ammeter. The ammeter section can indicate the current supplied by either left or right alternator switching a dedicated selector.

There are five different busses (make reference to Figure 11):

- Battery bus
- LH Alternator bus
- RH Alternator bus
- LH Avionic bus
- RH Avionic bus

The distribution system operates as a single bus with power being supplied by the battery and both alternator but it is possible to separate the left busses from the right busses when required by means of the Cross Bus switches.

All electrical loads are divided among the five busses on the basis of their importance and required power: equipment with duplicate functions are connected to separate busses.

The Battery bus, which supplies the most important loads, is energized from three sources: the battery and both alternator. This allows the bus for remaining active also in case of two independent faults in the supply paths.

The second ones allow, through a relay, for cutting off the power supply to the pertinent avionic bus.

When both generators are correctly operating and all above mentioned switches are in ON position, all the busses are connected to the generators.

The ignition switches, two for each engine and grouped on the over head panel, are instead independent from the airplane electrical system (generation and distribution); they only control and open the engine electrical circuit.

**WARNING**

If ignition switches are turned ON, a propeller movement can cause the engine starting with consequent hazard for people nearby.

18.1 MISSION POWER CONTROL

When the airplane embodies the design change “Power supply from built-in generators”, the Rotax engine built-in generators are enabled in order to supply power to two available bus bars.

Each built-in generator is activated by means of a switch (LH and RH AUX FIELD) located on the LH breakers rack where are located also the breakers related to the auxiliary power generation system.

The light (switch built-in light) indicates that the electrical power is being generated.

The below figure presents the control panel for the built-in generators which in turn activate the converter box:

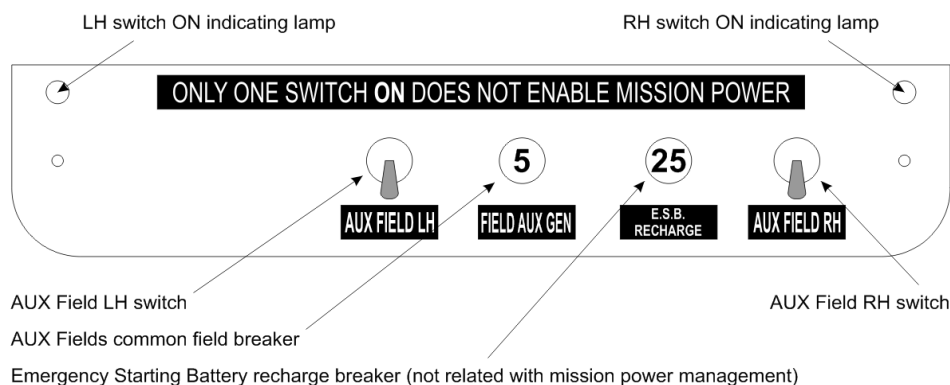

Switches panels

Next paragraph describes the converter and connector box installed in the P2006T baggage compartment floor. This box allows the operator to have a source of 28Volt/40Amp electrical power for different mission equipment.

18.1.1 CONVERTER BOX

The following points illustrate how the converter box works:

1. A closed, light alloy made box incorporates 4x converters Ameri-King AK-550-12, each one capable of 12Amp/28VDC output using a 14VDC input;
2. Each converter is fed by one different power generation:
 - 20Amp coming directly from the LH aux generator bus;
 - 20Amp coming directly from the RH aux generator bus;
 - 30Amp coming from the LH external alternator bus;
 - 30Amp coming from the RH external alternator bus;
3. Each converter is protected with circuit breakers on the INPUT and OUTPUT sides;
4. The 30Amp current coming from the LH and RH external alternators is the amount of power surplus available due to the 2006/202 design change;
5. The same switches shown in the MOD2006/046 and reported in the figure above enable the relays that feed the converters;
6. Four relays enable the external power to feed also the converter box for ground test purposes, when external socket is connected;
7. A connector box allows the end user to have a maximum current of 40Amp at 28VDC available (1120W).

NOTE

When using the ground power unit to test on-ground the mission equipment, remember that:

- 14VDC GPU only can be used, as done on standard P2006T.
- the minimum GPU capacity to properly feed mission equipment should be at least 150Amp @14VDC
- The FIELD AUX switches needs to be "ON" to test converter box connected equipment, "OFF" to test the aircraft avionics

NOTE

When connecting mission equipment to the system please note that the amount of current provided depends on engine rpm setting. The maximum electrical power is available from 1.900rpm on.

In the following figures the new Electrical system schematic is reported.

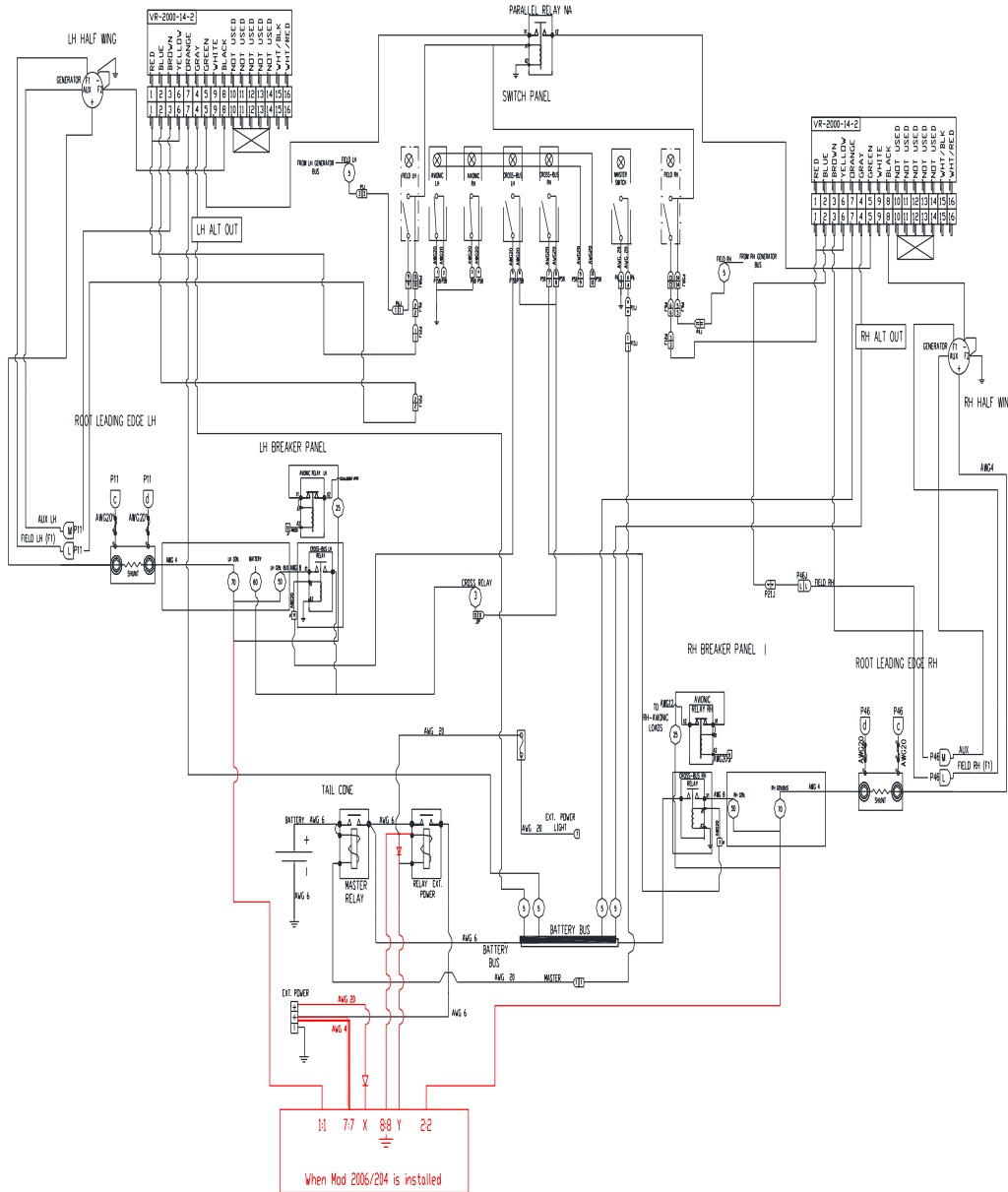

Electrical system schematic (Page 1)

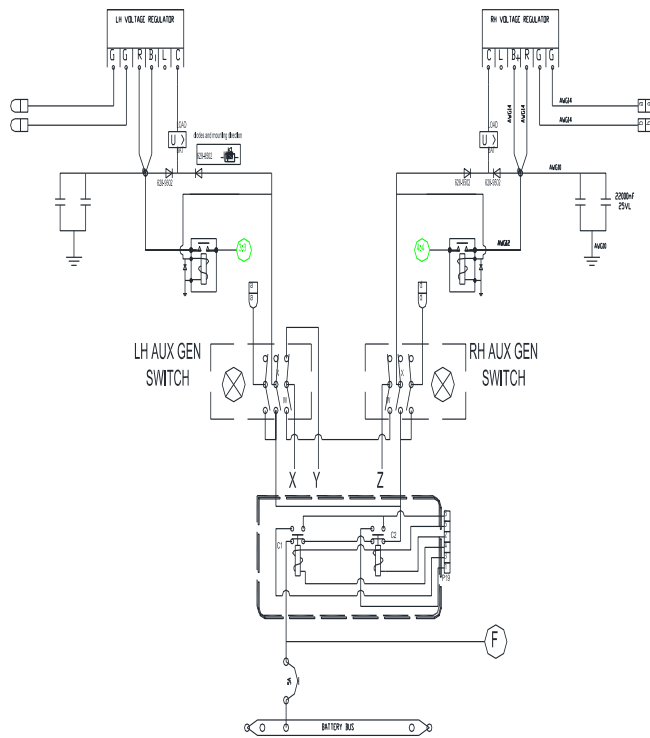
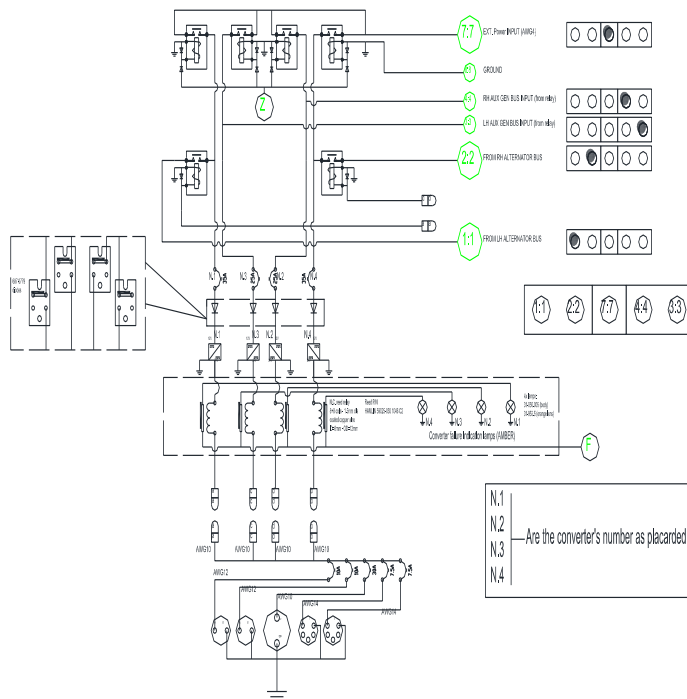

Figure 25 – Electrical system schematic (Page 2)



Electrical system schematic (Page 3)

INTENTIONALLY LEFT BLANK

Supplement G14: pages replacement instructions

SECTION 8 – GROUND HANDLING & SERVICE

Apply following instruction:

See Basic AFM - Section 8

INTENTIONALLY LEFT BLANK

SUPPLEMENT NO. G16 - MD302 ALTERNATIVE STAND-BY INSTRUMENT

RECORD OF REVISIONS

Rev	Revised page	Description of Revision	Tecnam Approval			EASA Approval Or Under DOA Privileges
			DO	OoA	HDO	
0	-	First issue	D. Ronca	C. Caruso	M. Oliva	DOA Approval

LOEP

	Pages	Revision
Cover pages	G16 – 1 thru 25	<i>Rev. 0</i>
Section 2	MD2 – 12	<i>Rev. 0</i>
Section 3	SMD3 – 15 thru 16	<i>Rev. 0</i>
	SMD3 – 30	<i>Rev. 0</i>
Section 4	SMD4 – 15	<i>Rev. 0</i>
Section 6	MD6 – 11	<i>Rev. 0</i>
Section 7	MD7 – 29	<i>Rev. 0</i>
	SMD7 – 37	<i>Rev. 0</i>
	SMD7 – 39	<i>Rev. 0</i>

INTRODUCTION

This section contains supplemental information to operate, in a safe and efficient manner, the aircraft when equipped with Garmin G950 Integrated Flight Deck System (Design Change MOD 2006/002) and with MD302. The MD302 refers to the following design change:

- MOD2006/212 - MD302 Alternative Stand-By Instrument

The information contained herein supplements or supersedes the basic Aircraft Flight Manual or the Supplement G1, as applicable: detailed instructions are provided to allow the owner for replacing the Basic AFM/Supplement G1 pages containing information amended as per the Design Change in subject.

It is the owner's/operator's responsibility to replace the mentioned pages in the AFM in accordance with the instructions herein addressed section by section.

INTENTIONALLY LEFT BLANK

Supplement G16: pages replacement instructions

SECTION 1 – GENERAL

Apply following instruction:

See Basic AFM - Section 1

INTENTIONALLY LEFT BLANK

Supplement G16: pages replacement instructions

SECTION 2 – LIMITATIONS

Apply following pages replacement procedure:

Supplement G16 - LIMITATIONS page		Basic AFM Section 2 page
MD2 – 12	REPLACES	Page 2 – 12 of Basic AFM, Section 2

INTENTIONALLY LEFT BLANK

11. POWERPLANT INSTRUMENTS MARKINGS

Powerplant instrument markings and their colour code significance are shown below:

INSTRUMENT		RED LINE Minimum limit	GREEN ARC Normal operating	YELLOW ARC Caution	RED LINE Maximum limit
Propeller	rpm	----	580 - 2265	2265 - 2388	2388
Oil temp.	°C	50	90 - 110	50 - 90 110 - 130	130
CT	°C	----	50 - 120	----	120
CHT ¹	°C	----	50 - 135	----	135
Oil pressure	bar	0.8	2 - 5	0.8 - 2 5 - 7 ⁽²⁾	7
Fuel press.	psi	2.2	2.2 - 5.8 or 7.2 ³	----	5.8 or 7.2 ³
Fuel Q.ty	litres	0 ⁽⁴⁾	----	----	----

12. OTHER INSTRUMENTS MARKINGS

INSTRUMENT	RED LINE Minimum limit	GREEN ARC Normal operating	YELLOW ARC Caution	RED LINE Maximum limit
Voltmeter	10.5 Volt	12 - 14 Volt	----	----

If MOD2006/212 is embodied markings are unchanged so refer to the basic AFM for information.

1 applicable for Engines up to serial no. 4924543(included) and repaired engine which doesn't change the cylinder head n°3 with new one (part no. 413195)

2- In event of cold starting operation, it is permitted a maximum oil pressure of 7 bar for a short period.

3- only applicable for fuel pump part no. 893110 or 893114

4 - "0" indication shows the unusable fuel quantity (2,8 litres for each fuel tank).

INTENTIONALLY LEFT BLANK

Supplement G16: pages replacement instructions

SECTION 3 – EMERGENCY PROCEDURES

Apply following pages replacement procedure:

Supplement G16 - EMERGENCY PROCEDURES page		Supplement S1 Section 3 page
MD3 – 15 thru 16	REPLACE	Page 3 – 15 thru 16 of Supplement S1, Section 3
MD3 – 30	REPLACES	Page 3 – 30 of Supplement S1, Section 3

Section 9 - Supplements

INTENTIONALLY LEFT BLANK

Section 9 - Supplements

Supplement no. G16 – MD302 ALTERNATIVE STAND-BY INSTRUMENT

2.9 LOSS OF INFORMATION DISPLAYED

When a LRU or a LRU function fails, a large red „X” is typically displayed on the display field associated with the failed data.

NOTE

In most of cases, the red “X” annunciation is accompanied by a message advisory alert issuing a flashing ADVISORY Softkey annunciation which, once selected, acknowledges the presence of the message advisory alert and displays the alert text message in the Alerts Window. Refer to G950 Pilot’s Guide for Tecnam P2006T (P/N 190-01146-00), last issue, Appendix A, Message Advisories list.

2.10 LOSS OF AIRSPEED INFORMATION

	<p>AIRSPEED FAIL (RED X ON DISPLAY FIELD)</p>
	<p>Display system is not receiving airspeed input from the Air Data Computer.</p>

INSTRUCTION: revert to stand-by airspeed indicator

2.10 LOSS OF ATTITUDE INFORMATION

	<p style="text-align: center;">ATTITUDE FAIL (RED X ON DISPLAY FIELD)</p>
	<p style="text-align: center;">Display system is not receiving attitude information from the AHRS.</p>

INSTRUCTION: revert to stand-by attitude indicator

2.11 LOSS OF ALTITUDE INFORMATION

	<p style="text-align: center;">ALTITUDE FAIL (RED X ON DISPLAY FIELD)</p>
	<p style="text-align: center;">Display system is not receiving altitude input from the Air Data Computer.</p>

INSTRUCTION: revert to stand-by altitude indicator

5.3 MD 302 BATTERY FAILURE

**WARNING**

The MD302 internal battery will recharge itself from aircraft power while in normal mode. A battery capacity check occurs each time the unit is powered on. If the battery capacity is determined to be less than 80%, there will be a battery pack warning. If the warning persists more than once in a short time the battery must be replaced.

5.4 STATIC PORTS FAILURE

In case of static ports failure, the alternate static port in the cabin (shown below) must be activated.



- | | |
|--------------------------------|-------------------------------|
| 1. Cabin ventilation | <i>OFF (hot and cold air)</i> |
| 2. ALTERNATE STATIC PORT VALVE | <i>OPEN</i> |
| 3. Continue the mission | |

INTENTIONALLY LEFT BLANK

Section 9 - Supplements

Supplement no. G16 – MD302 ALTERNATIVE STAND-BY INSTRUMENT

Supplement G16: pages replacement instructions

SECTION 4 – NORMAL PROCEDURES

Apply following pages replacement procedure:

Supplement G16 - NORMAL PROCEDURES page		Supplement S1 Section 4 page
SMD4 – 15	REPLACES	Page 4 – 15 Supplement S1, Section 4

INTENTIONALLY LEFT BLANK

Section 9 - Supplements

Supplement no. G16 – MD302 ALTERNATIVE STAND-BY INSTRUMENT

MD302 system use



“The detailed description, operation and functionalities of MD302 Stand By Attitude Module are provided on MD302 Stand-By Attitude Module Pilot’s Guide” document P/N 9017846 rev.D, which is to be considered to be attached to this AFM and kept onboard the aircraft.

INTENTIONALLY LEFT BLANK

Section 9 - Supplements

Supplement G16: pages replacement instructions

SECTION 5 – PERFORMANCE

Apply following instruction:

See Basic AFM - Section 5

INTENTIONALLY LEFT BLANK

Section 9 - Supplements

Supplement no. G16 – MD302 ALTERNATIVE STAND-BY INSTRUMENT

Supplement G16: pages replacement instructions

SECTION 6 – WEIGHT AND BALANCE

Apply following instruction:

Supplement G16 - WEIGHT AND BALANCE page		Basic AFM Section 6 page
MD6 – 11	REPLACES	Page 6 – 11 of Basic AFM, Section 6

INTENTIONALLY LEFT BLANK

EQUIPMENT LIST		AIRCRAFT S/N _____	DATE:		
REF.	DESCRIPTION	P/N	INST	WEIGHT [kg]	ARM [M]
INSTRUMENTATION					
A1	GARMIN G950 IFDS				
A2	SOFTWARE SD CARD P/N				
A3	2 nd airspeed indicator – UMA T6-311 – 200			0.37	-1.4
A4	2 nd airspeed indicator - UMA T6-311 –			0.37	-1.4
A5	2 nd attitude indicator - Kelly Manufacturing RCA26AK-3			1	-1.4
A6	2 nd altimeter - Altimeter - United Instruments 5934PM- 3A84 01770028-05			0.6	-1.4
A7	Turn and bank indicator – RCA 83A-11			1.2	-1.4
A8	Mid-Continent MD302 stand-by instrument			0.73	-1.4
AVIONICS & MISCELLANEOUS					
B1	Garmin GNS-430W GPS/WAAS COMM/NAV			3	-1.4
B2	Garmin GNS-530W GPS/WAAS COMM/NAV			3,18	-1.4
B3	Garmin GMA340 audio panel			0.8	-1.4
B4	Garmin GMA347 audio panel			0.8	-1.4
B5	Garmin SL30 VHF COMM/NAV			1.3	-1.4
B6	Transponder-Garmin GTX328			1.9	-1.4
B7	Transponder-Garmin GTX330			1.5	-1.4
B8	Becker BXP 6401-2-(01) Mode S transponder			0.8	-1.4
B9	Vor/Loc/GS Indicator–Garmin GI106A			0.4	-1.4
B10	Vor/Loc/GS Indicator -MID Continental MD 200-306			0,4	-1,44
B11	Directional Gyro - Kelly Manufacturing RCA15AK-1			1	-1.4
B12	Directional Gyro - Kelly Manufacturing RCA15AK-16			1	-1.4
HONEYWELL Bendix/King KCS 55A Compass System					
B13	KI 525A Pictorial Navigation Indicator			1.53	-1.4
B14	KG 102A Directional Gyro			1.95	1
B15	KA 51B Slaving Control and Compensator Unit			0.1	-1.4
B16	KMT 112 Magnetic Slaving Transmitter			0.15	2.2
HONEYWELL Bendix/King ADF KR87 system:					
B17	ADF KR87 receiver			1.5	1
B18	Indicator KI 227			0.3	-1.4

INTENTIONALLY LEFT BLANK

Supplement G16: pages replacement instructions

SECTION 7 – AIRFRAME AND SYSTEMS DESCRIPTION

Apply following pages replacement procedure:

Supplement G16 - AIRFRAME AND SYSTEM DESCRIPTION page		Basis AFM/Supplement S1 Section 7 page
MD7 – 29	REPLACES	Page 7 – 29 of Basic AFM, Section 7
SMD7 – 37	REPLACES	Page 7 – 37 of Supplement S1, Section 7
SMD7 – 39	REPLACES	Page 7 – 39 of Supplement S1, Section 7

INTENTIONALLY LEFT BLANK

16. MD302 ALTERNATIVE STAND-BY INSTRUMENT

In order to improve the digital version cockpit layout of the P2006T in terms of human-machine interface, weight saving and reliability this backup instrument V.1.0.5 is installed.

For more details refer to MOD2006/212.



All MD302 Stand-by Attitude Module settings, set up during the aircraft delivery or after a maintenance activity, must not be modified.



In case of replacement of MD302 Stand-by Attitude Module, verify proper software load and confirm that its software version number is compliance with that one showed above, before install it.

17. INSTRUMENTS PANEL

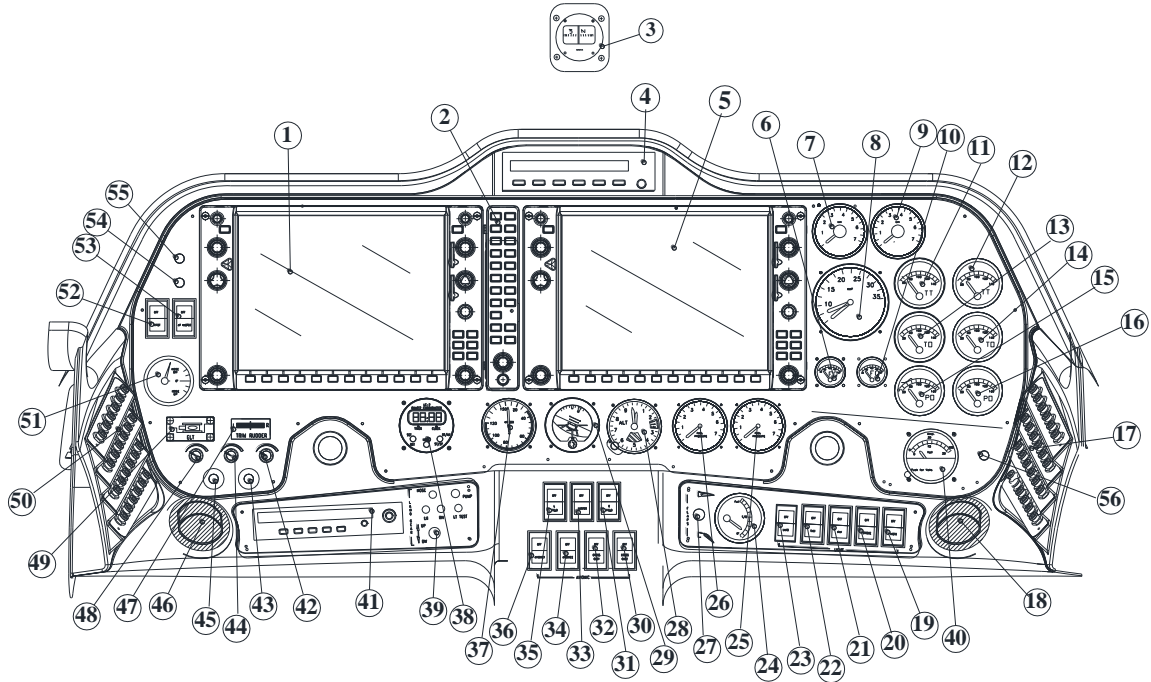

GARMIN G950 IFDS - Instruments panel (typical layout)

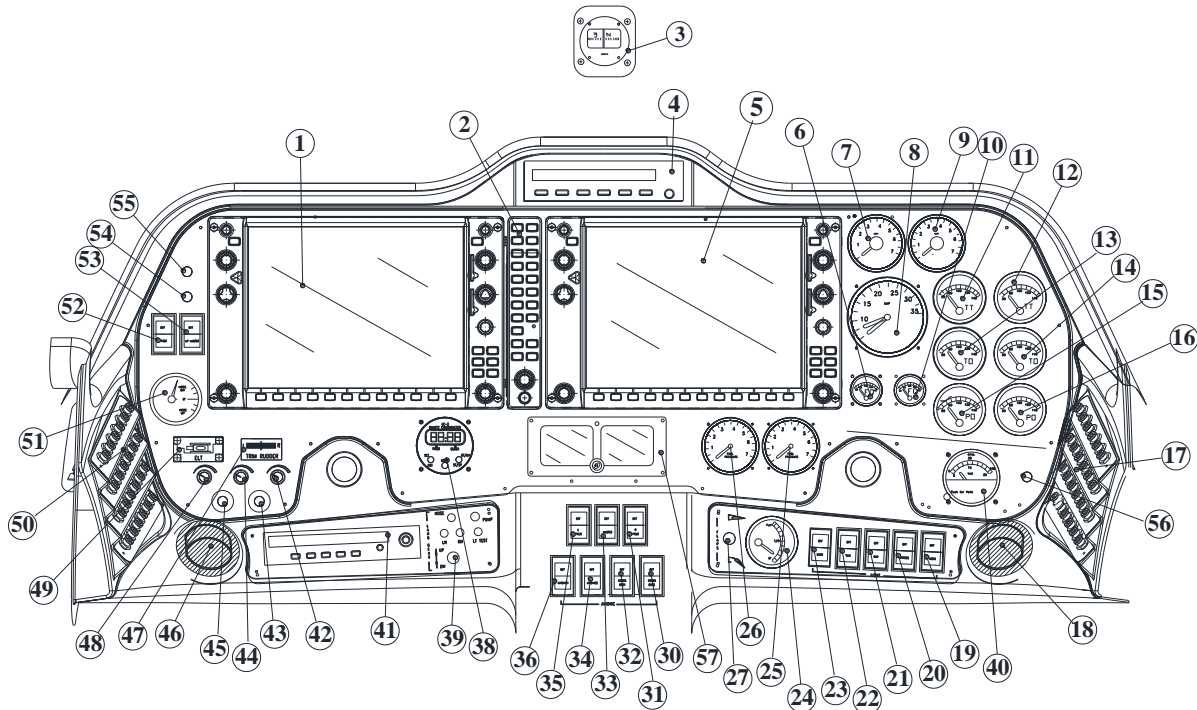

GARMIN G950 IFDS - Instruments panel - layout with MD302 digital stand-by instrument(MOD2006/212)

Item	Description
31	RH Field
32	LH Cross bus switch
33	Master switch
34	RH Avionic switch
35	LH Field
36	LH Avionic switch
37	Standby Airspeed indicator
38	Chronometer
39	LG control knob
40	Voltammeter Indicator
41	ADF control panel
42	Cockpit light dimmer
43	Cabin heat (warm air from RH engine)
44	Avionics lights dimmer
45	Cabin heat (warm air from LH engine)
46	LH ram air inlet
47	Trim rudder indicator
48	Switches built-in lights dimmer
49	ELT Indicator
50	RH breakers panel
51	Pitch trim indicator
52	Pitot heat switch
53	A/P Master switch
54	A/P trim master switch
55	Fire Detector push-to-test
56	LH/RH Ammeter selector switch
57	Mid-Continent MD302 Stand-By Instrument

INTENTIONALLY LEFT BLANK

Supplement G16: pages replacement instructions

SECTION 8 – GROUND HANDLING & SERVICE

Apply following instruction:

See Basic AFM - Section 8

INTENTIONALLY LEFT BLANK

SUPPLEMENT NO. G17 - STORMSCOPE

RECORD OF REVISIONS

Rev	Revised page	Description of Revision	Tecnam Approval			EASA Approval Or Under DOA Privileges
			DO	OoA	HDO	
0	-	First issue	D. Ronca	C. Caruso	M. Oliva	DOA Approval

LOEP

	Pages	Revision
Cover pages	G17 – 1 thru 21	<i>Rev. 0</i>
Section 1	ST1 – 9	<i>Rev. 0</i>
Section 6	ST6 – 12	<i>Rev. 0</i>
Section 7	ST7 – 46	<i>Rev. 0</i>

INTRODUCTION

This section contains supplemental information to operate, in a safe and efficient manner, the aircraft when equipped with WX500 Stormscope; this equipment refers to the following design change:

- MOD2006/216 – Stormscope installation

The information contained herein supplements or supersedes the basic Aircraft Flight Manual or the Supplement G1, as applicable: detailed instructions are provided to allow the owner for replacing the Basic AFM/Supplement G1 pages containing information amended as per the Design Change in subject.

It is the owner's/operator's responsibility to replace the mentioned pages in the AFM in accordance with the instructions herein addressed section by section.

INTENTIONALLY LEFT BLANK

Supplement G17: pages replacement instructions

SECTION 1 – GENERAL

Apply following instruction:

See Basic AFM - Section 1

INTENTIONALLY LEFT BLANK

NOTE

The Stormscope does neither replace a weather radar nor weather information. The Stormscope is only used as an additional source of information beside approved weather information.

INTENTIONALLY LEFT BLANK

Supplement G17: pages replacement instructions

SECTION 2 – LIMITATIONS

Apply following instruction:

See Basic AFM and Supplement S1 - Section 2

INTENTIONALLY LEFT BLANK

Supplement G17: pages replacement instructions

SECTION 3 – EMERGENCY PROCEDURES

Apply following instruction:

See Supplement S1 - Section 3

INTENTIONALLY LEFT BLANK

Supplement G17: pages replacement instructions

SECTION 4 – NORMAL PROCEDURES

Apply following instruction:

See Supplement S1 - Section 4

INTENTIONALLY LEFT BLANK

Supplement G17: pages replacement instructions

SECTION 5 – PERFORMANCES

Apply following instruction:

See Basic AFM - Section 5

INTENTIONALLY LEFT BLANK

Supplement G17: pages replacement instructions

SECTION 6 – WEIGHT AND BALANCE

Apply following instruction:

Supplement G17 - WEIGHT AND BALANCE page		Basic AFM Section 6 page
ST6 – 12	REPLACES	Page 6 – 12 of Basic AFM, Section 6

INTENTIONALLY LEFT BLANK

EQUIPMENT LIST		AIRCRAFT S/N _____	DATE:		
REF.	DESCRIPTION	P/N	INST	WEIGHT [kg]	ARM [M]
<i>AVIONICS & MISCELLANEOUS (CONT'D)</i>					
B19	Indicator KI 229			1.3	-1.4
B20	Static inverter Marathon PC-50			2	1
HONEYWELL Bendix/King DME KN 63 system					
B21	Indicator DME KDI 572			0.4	-1.4
B22	Transceiver DME KN 63			1.3	1
S-TEC Fifty Five X Autopilot System					
B23	Turn coordinator S-TEC 6405-14L (Mid Continent 1394T100-14RB)			0.81	-1.4
	Turn coordinator Mid Continent 1394T100-7Z			0.81	-1.4
B24	PRGMR/CMPTR 01192-0-2TF			1.36	-1.4
B25	Roll servo 0105-5-R9			1.31	-0.71
B26	Pitch servo 0107-11-P4			1.31	3.55
B27	Altitude Transducer 0111			0.2	-1.9
B28	Pitch Trim servo S-TEC 0105- T11			1.3	2.8
B29	ELT Adams Aviation Artex ME406			0.9	0.8
B30	LH Front and rear seat GEVEN E5-01-003-T01 or E5-01-007-T01 or E5-01-009-T03			9	- 0.893
B31	RH Front and rear seat GEVEN E5-01-004-T01 or E5-01-008-T01 or E5-01-010-T03			9	0.226
B32	Fire extinguisher Fire Fighting Enterprises Ltd BA51015-3			2	-1.5
B33	First aid kit Euroferramenta s.r.l. FIA270160			0.2	0.8
B34	Torch			0.15	-1.5
B35	Battery GILL35 - 13Volt - 23Ah			12.2	3.7
B36	ELT KANNAD 406			0.9	0.8
B37	Fire extinguisher H3R-Aviation RTA-600			0.8	-1.5
B38	Processor (including mounting tray)	805-11500-001		1,1	2,51
B39	Antenna NY163	805-10930-001		0,38	3,60

INTENTIONALLY LEFT BLANK

Supplement G17: pages replacement instructions

SECTION 7 – AIRFRAME AND SYSTEMS DESCRIPTION

Apply following instruction:

Supplement G17 - AIRFRAME AND SYSTEM DESCRIPTION page		Supplement S1 Section 7 page
ST7 – 46	REPLACES	Page 7 – 46 of Supplement S1, Section 7

INTENTIONALLY LEFT BLANK

19. WX500 STORMSCOPE SYSTEM

The thunderstorm detection passive sensor WX500 Stormscope is fully operated and displayed via the Garmin G950 Multi function display, in the map menu. Is installed in order to shown the lightning data.

The sensor maps discharge the electrical activity for 360 degrees around the aircraft to a distance of 200 nautical miles, in relation to the aircraft's *Stormscope* antenna. The estimated distance from the aircraft to the discharge point is reported in NM while the bearing represents the angle between the fore and aft axis of the antenna, which is in line with the longitudinal axis (nose) of the aircraft.

The WX-500 processor is installed in the right side of the baggage compartment while the NY-163 antenna is installed on the bottom side of the tail.

For more details see WX-500 Installation Manual and the latest revision of the Garmin G950 Pilot's guide Doc. No.: 190-00726-00.

19.1 WIRING DIAGRAM - CABLE INTERCONNECTION

In the following figure the *Stormscope* wiring diagram is reported.

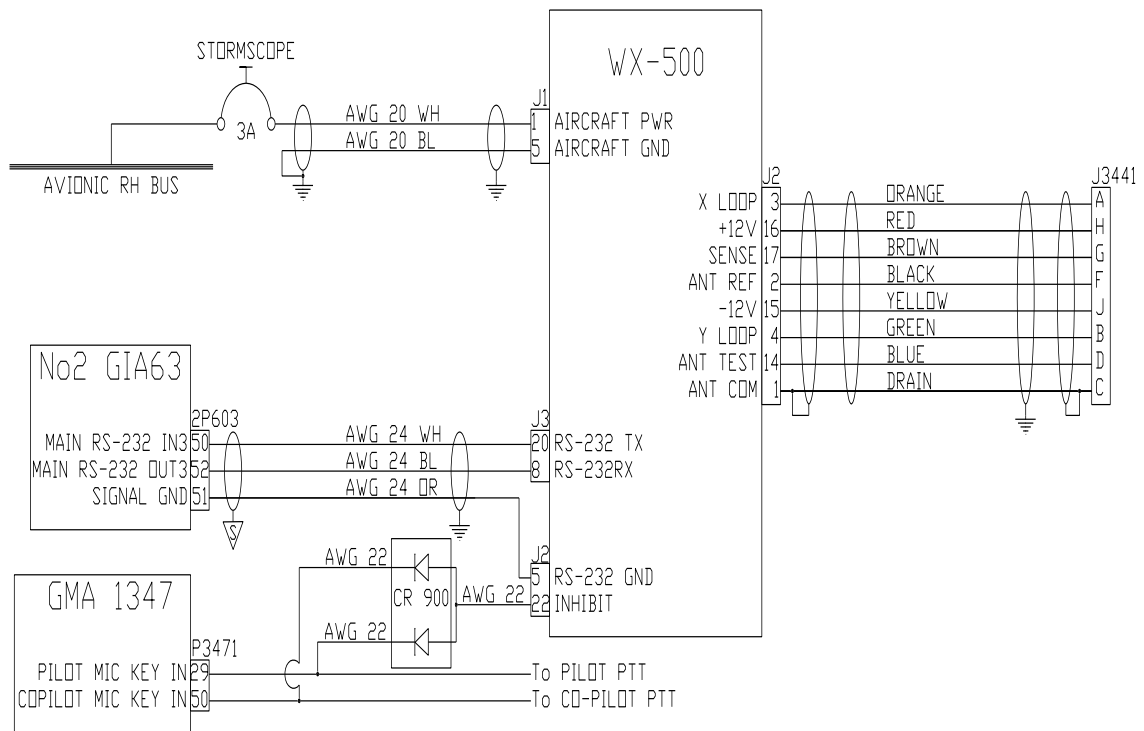

Wiring diagram

INTENTIONALLY LEFT BLANK

Supplement G17: pages replacement instructions

SECTION 8 – GROUND HANDLING & SERVICE

Apply following instruction:

See Basic AFM - Section 8

INTENTIONALLY LEFT BLANK

SUPPLEMENT NO. G18 – OIL TEMPERATURE INDICATOR UPDATE

RECORD OF REVISIONS

Rev	Revised page	Description of Revision	Tecnam Approval			EASA Approval Or Under DOA Privileges
			DO	OoA	HDO	
0	-	First issue	D. Ronca	C. Caruso	M. Oliva	DOA Approval

LOEP

	Pages	Revision
Cover pages	G18 – 1 thru 22	<i>Rev. 0</i>
Section 2	OT2 – 12	<i>Rev. 0</i>
Section 4	SOT4 – 26	<i>Rev. 0</i>

INTRODUCTION

This section contains supplemental information to operate, in a safe and efficient manner, the aircraft when equipped with Garmin G950 Integrated Flight Deck System (Design Change MOD 2006/002) and with an update of the Oil temperature indicator. The update of the Oil temperature indicator refers to the following design change:

- MOD2006/280 - Oil temperature indicator update

The information contained herein supplements or supersedes the basic Aircraft Flight Manual or the Supplement G1, as applicable: detailed instructions are provided to allow the owner for replacing the Basic AFM or the Supplement G1 pages containing information amended as per the Design Change in subject.

It is the owner's/operator's responsibility to replace the mentioned pages in the AFM in accordance with the instructions herein addressed section by section.

INTENTIONALLY LEFT BLANK

Supplement G18: pages replacement instructions

SECTION 1 – GENERAL

Apply following instruction:

See Basic AFM - Section 1

INTENTIONALLY LEFT BLANK

Supplement G18: pages replacement instructions

SECTION 2 – LIMITATIONS

Apply following pages replacement procedure:

Supplement G18 - LIMITATIONS page		Basic AFM Section 2 page
OT2 – 12	REPLACES	Page 2 – 12 of Basic AFM, Section 2

INTENTIONALLY LEFT BLANK

11. POWERPLANT INSTRUMENTS MARKINGS

Powerplant instrument markings and their colour code significance are shown below:

INSTRUMENT		RED LINE Minimum limit	GREEN ARC Normal operating	YELLOW ARC Caution	RED LINE Maximum limit
Propeller	rpm	----	580 - 2265	2265 - 2388	2388
Oil temp.	°C	50	50 - 130	----	130
CT	°C	----	50 – 120	----	120
CHT ¹	°C	----	50 – 135	----	135
Oil pressure	bar	0.8	2 - 5	0.8 - 2 5 - 7 ⁽²⁾	7
Fuel press.	psi	2.2	2.2 - 5.8 or 7.2 ³	----	5.8 or 7.2 ³
Fuel Q.ty	litres	0 ⁽⁴⁾	----	----	----

12. OTHER INSTRUMENTS MARKINGS

INSTRUMENT	RED LINE Minimum limit	GREEN ARC Normal operating	YELLOW ARC Caution	RED LINE Maximum limit
Voltmeter	10.5 Volt	12 - 14 Volt	----	----

1 applicable for Engines up to serial no. 4924543(included) and repaired engine which doesn't change the cylinder head n°3 with new one (part no. 413195)

2- In event of cold starting operation, it is permitted a maximum oil pressure of 7 bar for a short period.

3- only applicable for fuel pump part no. 893110 or 893114

4 - "0" indication shows the unusable fuel quantity (2,8 litres for each fuel tank).

INTENTIONALLY LEFT BLANK

Supplement G18: pages replacement instructions

SECTION 3 – EMERGENCY PROCEDURES

Apply following instruction:

See Basic AFM - Section 3

INTENTIONALLY LEFT BLANK

Supplement G18: pages replacement instructions

SECTION 4 – NORMAL PROCEDURES

Apply following pages replacement procedure:

Supplement G18 - NORMAL PROCEDURES page		Supplement S1 Section 4 page
SOT4 – 26	REPLACES	Page 4 – 26 of Supplement S1, Section 4

INTENTIONALLY LEFT BLANK

3.10 CRUISE

- 1 LH and RH Propeller Lever *SET to 1900-2250 RPM*

**CAUTION**

Throttles MAP decrease should be made before propeller speed reduction below 2200 RPM, as, contrariwise, Propeller Lever increase RPM should be set before engine Throttle Levers are advanced.

- 2 Engine parameters check (LH and RH)

- Oil temperature: $50^{\circ} \div 130^{\circ} \text{ C}$.
- CHT: $90^{\circ} \div 110^{\circ} \text{ C}$
- Oil pressure: $2 - 5 \text{ bar}$.
- Fuel pressure: $2.2 - 5.8 \text{ psi}$
 $*2.2 - 7.26 \text{ psi (0.15 - 0.50 bar)}$

**applicable for fuel pump part no.893110 and no.893114*

- 3 Carburettor heat as needed (*see also instructions addressed on Section 3, Para. 7.4*)

**WARNING**

Deselect and do not use Auto Pilot if possible icing condition area is inadvertently entered.

- 4 Fuel balance and crossfeed *check as necessary*

NOTE

To evaporate possibly accumulated condensation water, once per flight day (for approximately 5 minutes) 100° C (212° F) oil temperature must be reached.

3.11 TURBULENT AIR OPERATION

In keeping with good operating practice used in all aircraft, it is recommended that when turbulent air is encountered or expected, the airspeed be reduced to maneuvering speed to reduce the structural loads caused by gusts and to allow for inadvertent speed build-ups, which may occur as a result of the turbulence or of distractions caused by the conditions.

INTENTIONALLY LEFT BLANK

Supplement G18: pages replacement instructions

SECTION 5 – PERFORMANCE

Apply following instruction:

See Basic AFM - Section 5

INTENTIONALLY LEFT BLANK

Supplement G18: pages replacement instructions

SECTION 6 – WEIGHT AND BALANCE

Apply following instruction:

See Basic AFM - Section 6

INTENTIONALLY LEFT BLANK

Supplement G18: pages replacement instructions

SECTION 7 – AIRFRAME AND SYSTEMS DESCRIPTION

Apply following instruction:

See Basic AFM - Section 7

INTENTIONALLY LEFT BLANK

Supplement G18: pages replacement instructions

SECTION 8 – GROUND HANDLING & SERVICE

Apply following instruction:

See Basic AFM - Section 8

INTENTIONALLY LEFT BLANK